

# Guide to Best Practice for Waste Management in Multi-unit Developments

# Guide to Best Practice for Waste Management in Multi-unit Developments (October 2010)

## **Disclaimer**

While all professional care has been taken in preparing this document, Sustainability Victoria accepts no liability for loss or damages incurred as a result of reliance placed upon its content.

## **Acknowledgements**

Sustainability Victoria would like to thank the Department of Environment, Climate Change & Water NSW for giving permission to use the *Better Practice Guide for Waste Management in Multi-Unit Dwellings* DECC 2008/42 in the preparation of this document.

# Contents

Glossary	3
Abbreviations	4
Units	4
<b>1. Introduction</b> .....	<b>5</b>
What is best practice?	5
Why incorporate best practice?	5
What is in this guide?	6
Links to other planning requirements	7
Strategic context	8
What is my role?	8
How to use this guide	10
<b>2. All developments</b> .....	<b>11</b>
Council service provision	11
Risks to health and safety associated with handling and disposal of waste and recycled material	11
Access to garbage and recycling bins	13
Bins and containers	13
Waste handling equipment	13
Storage	14
Contracts	16
Collection point	17
Access for service providers	18
Composting	20
Noise	20
Odour	20
Hygiene/vermin	20
Visual amenity	21
Security	21
Signs and education	21
Ongoing management	22
Costs	22
<b>3. Villas and townhouses</b> .....	<b>23</b>
Issues for consideration	23
Best practice garbage and recycling systems and services	23
Example diagrams	27
<b>4. Low-rise developments</b> .....	<b>29</b>
Issues for consideration	29
Best practice garbage and recycling systems and services	29
Storage – space and location	32
Garbage and recyclables collection point	32
Example diagrams	33

<b>5. Residential blocks 4–7 storeys .....</b>	<b>35</b>
Issues for consideration	35
Best practice garbage and recycling systems and services	35
Storage – space and location	41
Supporting infrastructure	41
Access	42
Ongoing management	42
Example diagrams	43
<b>6. High-rise residential blocks more than seven storeys .....</b>	<b>47</b>
Issues for consideration	47
Best practice garbage and recycling systems and services	47
Storage – space and location	52
Supporting infrastructure	52
Access	53
Ongoing management	53
Example diagrams	54
<b>7. Mixed-use development .....</b>	<b>57</b>
Issues for consideration	57
Best practice garbage and recycling systems and services	58
Storage – space and location	63
Supporting infrastructure	65
Access	65
Ongoing management	66
Example diagrams	66
<b>8. Integrated housing development .....</b>	<b>69</b>
Issues for consideration	69
Best practice garbage and recycling systems and services	70
Access	70
Storage – space and location	71
Waste collection point	71
Example diagrams	72
<b>Appendices .....</b>	<b>75</b>
<b>Appendix A</b> Waste generation rates (MUDs)	75
<b>Appendix B</b> Waste management equipment	85
<b>Appendix C</b> Collection vehicles	93
<b>Appendix D</b> Vehicle access/turning circles	97
<b>Appendix E</b> Standard signage	103
<b>Appendix F</b> Checklist	104

# Glossary

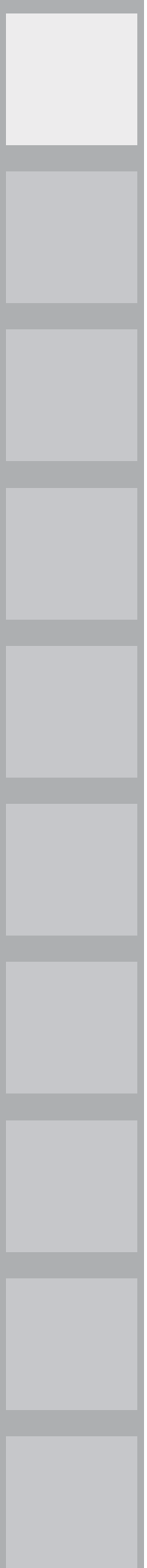
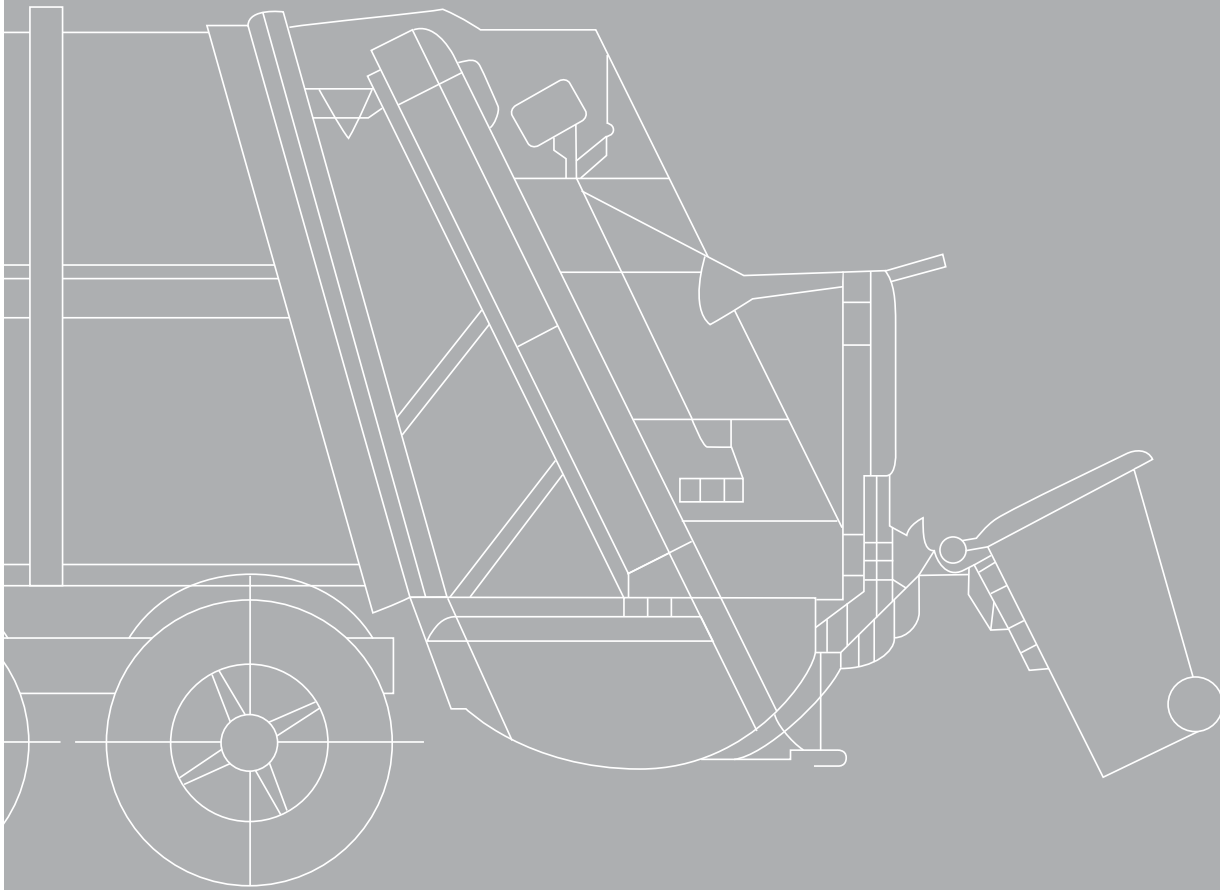

# Glossary

<b>Amenity</b>	The quality of a local environment in relation to health and pleasantness.
<b>Best practice</b>	Represents current state-of-the-art practice and aims to produce outcomes consistent with the community's social, economic and environmental expectations. Continuous improvement is an important component of best practice.
<b>Best practice waste management</b>	Refers to installation and maintenance of services and infrastructure that enable garbage, recyclables, organics and bulk waste handling systems and collection services to achieve the best possible waste minimisation outcomes.
<b>Body corporate</b>	See Owners corporation
<b>Bulk bin</b>	Refers to a bin for garbage or recyclables with capacity of 1m <sup>3</sup> or more, generally fitted with wheels for manoeuvrability.
<b>Bulk waste collection</b>	Services and facilities to manage bulky household items that would not be collected in typical garbage services. See Hard waste
<b>Collection point</b>	The point from which garbage and recyclables are collected and transferred from the storage receptacle to the collection vehicle.
<b>Contamination</b>	Materials and items within a recycling process that are not readily recycled by that process.
<b>Garden organics</b>	Organics derived from garden sources, e.g. grass clippings, tree prunings.
<b>Hard waste</b>	Old furniture, whitegoods or other household items that are too large for the conventional kerbside waste collection service.
<b>Household waste</b>	Solid waste generated from households.
<b>Indemnity</b>	Indemnity means that a party providing services to a particular property will not be held responsible for any loss or damage to such property as a result of the routine provision of services.
<b>Kerbside collection</b>	Collection by local council collection services of household garbage and recyclable materials (separated or commingled).
<b>Municipal waste</b>	Solid waste generated from households and municipal activities.
<b>National Packaging Covenant</b>	A self-regulatory agreement between key stakeholders in the packaging supply chain and all spheres of government.
<b>Owners corporation</b>	An organisation or group of persons that is identified by a particular name and that acts, or may act, as an entity.
<b>Planning permit</b>	A statement that a particular use or development (subdivision, buildings and works) may proceed on a specified parcel of land.
<b>Planning scheme</b>	Sets out policies and controls for the use, development and protection of land for an area. The planning scheme is a legal document.
<b>Risk assessment</b>	A systematic process for assessing and integrating professional judgments about probable adverse conditions and/or events.





**State Planning  
Policy Framework**

The framework comprises general principles for land use and development in Victoria and specific policies dealing with settlement, environment, housing, economic development, infrastructure and particular uses and development. To ensure integrated decision making, planning authorities and responsible authorities must adhere to the general principles and the specific policies contained in the State Planning Policy Framework.

**Undercroft**

The area underneath a building, but not underground, with architectural supports like columns, pillars or posts. The area is open and often able to be used for parking.

**Waste  
management plan**

A document that addresses the management of waste and includes details of the type and quantity of materials (garbage and recyclables) that are likely to be generated, how they will be stored and collected; and information about handling procedures. In this guide, a plan refers either to a site plan (to address the demolition/construction stage) or a plan for the building once in operation of. Such a plan should be required as a permit condition.

## Abbreviations

- MGBs     Mobile garbage bins
- MUDs     Multi-unit developments
- OH&S    Occupational health & safety

## Units

- kg        kilogram
- l         litre
- m        metre
- m<sup>2</sup>      square metre
- m<sup>3</sup>      cubic metre
- mm      millimetre
- t         tonne

# 1

## Introduction

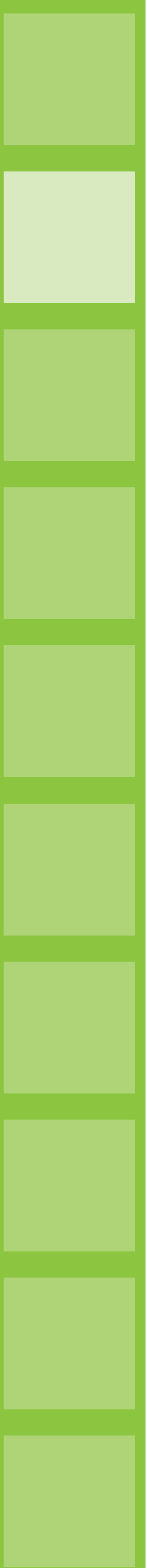
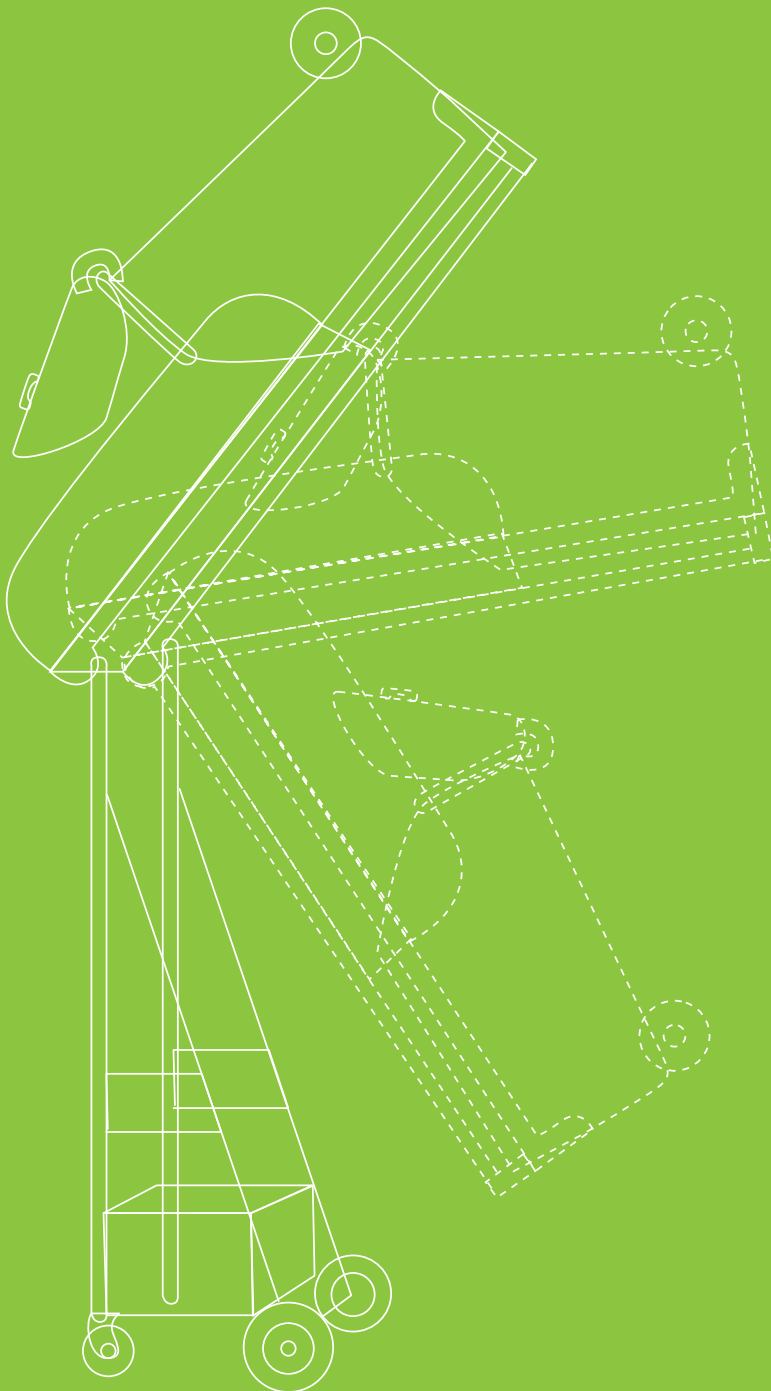



**This guide has been developed to assist those involved in designing, planning, developing, building and managing multi-unit developments (MUDs) to incorporate best practice waste management into all stages of a development's life. It outlines essential points to consider when designing a waste management system for medium- or high-density residential, mixed-use and integrated housing developments.**

## What is best practice?

Best practice encourages appropriate action and behaviour regarding waste management and increases the amenity, ease of use of waste services, environmental performance – and ultimate reputation – of developments with well-managed waste facilities.

Waste management systems in MUDs may incorporate any or all of the following:

- garbage services to manage residual domestic wastes, i.e. the wastes not collected by a dedicated recyclables or organics collection service
- recycling services to manage dry recyclable materials. These can vary between councils, but generally cover those generated in a typical household: paper and cardboard, glass bottles and jars, steel cans and aerosols, aluminium packaging and plastic containers. Recyclables may be collected as separate streams of each material type or as a commingled (mixed) stream
- organics services to manage garden and food organics, which may include a bin-based collection system or on-site composting
- bulky waste services to manage bulky household items, such as furniture or whitegoods. Note: materials collected in bulky waste services differ across local government areas.

Best practice waste management therefore establishes the design and provision and maintenance of services and infrastructure that enable garbage, recycling, organics and bulky waste services to be made in the best possible way to improve resource recovery. Best practice requires continuously searching for ways to improve infrastructure, systems and services as knowledge and experience accumulates over time.

Best practice management systems are effective and safe. Residents can use them with ease and collection crews can easily access and service them. The design, installation and ongoing management of best practice systems encourage residents to use the services appropriately. This includes greater participation in the services provided, minimised waste generation, increased resource recovery and reduced contamination of recyclables and organics.

## Why incorporate best practice?

It is important that we take steps to tackle waste generation and put in place resource recovery services (such as recycling and organics services) to reduce the environmental impacts of our consumption and disposal habits.

Resource recovery services to single-dwelling domestic households can divert more than 50% of domestic waste from landfill; however, the current recovery level from MUDs is often significantly less than this. It is important to incorporate best practice waste management systems in all new MUDs to increase resource recovery and to improve overall environmental and social outcomes.

Low participation rates in recycling occur if the system is not convenient. This particularly occurs in multi-unit developments containing garbage chutes and a central storage area for recyclables, when the absence of a recycling bin on each floor makes it easier to place recyclables in the garbage bin.

The lack of any recyclables collection service to existing developments further affects overall recycling results. This may happen when a development uses a privately contracted garbage collection service only and/or a council has not required a waste management plan. Councils should encourage these developments to expand the private garbage collection services to include recyclables collection. Councils should also avoid using private contractors who do not incorporate recyclables collection, and not offer a refund to site owners for a privately provided service if this is the case. Councils could consider having an environmental levy for waste and recycling education which is charged regardless of service provider.

Best practice waste management can also help maintain a development's aesthetic appeal and efficient management. Facilities for garbage, recycling and organics are essential aspects of a building that are often overlooked or undervalued. If designed and managed properly, they are virtually invisible to the occupants. If designed or managed poorly, they are a perpetual irritation, which can become worse as the building ages. Planning at the design stage is essential; it can save a great deal of difficulty and inconvenience for residents, building managers and collectors throughout the life of the building.

# Introduction

Guide to Best Practice for Waste Management in Multi-unit Developments

## What is in this guide?

This guide provides a list of essential issues to be considered when designing best practice waste management systems for MUDs. Examples of system options, based on actual developments, are provided as a guide to best practices. However, architects and building designers should not feel constrained by these examples. The main features, advantages and disadvantages of suggested best practice systems are provided for a range of developments (see below) to help consider and evaluate alternative systems to those presented in the guide.

Garbage and recycling requirements for residential development categories not included in the guide should be discussed with council.

The guide does not cover waste management requirements for commercial and industrial developments, although some of the information is applicable regardless of purpose.

Development Type	Description
Villas and townhouses	<p>Villas and townhouses are one- to two-storey dwellings, where there are three or more dwellings on the same parcel of land, all at ground level. They often have a small yard and/or a car space per dwelling.</p> <p>Elements of this development type are also relevant to nursing homes, retirement villages and the residential component of caravan and holiday parks.</p>
Low-rise developments	<p>This category includes two- to three-storey 'walk-ups' – small blocks of units (4–12 units), with separate dwellings on each storey. They are called walk-ups because they are not required to have a lift, and access to the upper storeys is by stairs.</p> <p>Elements of this development type are also relevant to the residential component of hotels and serviced units.</p>
Residential blocks of four to seven storeys	<p>These developments are medium to large blocks of units that are four to seven storeys high, with separate dwellings on each storey. Blocks of units with four or more storeys must have lift access to the upper levels.</p> <p>Elements of this development type are also relevant to the residential component of hotels and serviced units.</p>
High-rise developments (> seven storeys)	<p>High-rise developments are large blocks of units that are more than seven storeys high, with separate dwellings on each storey. Blocks of units with four or more storeys must have lift access to the upper levels.</p> <p>Elements of this development type are also relevant to the residential component of hotels and serviced units.</p>
Mixed-use developments	<p>Mixed-use developments incorporate residential dwellings and commercial establishments within the same development, and would include, for example, shop-top housing.</p> <p>Mixed-use developments may be small, for example two storeys incorporating a residential property on the top floor and commercial outlet on ground level, or they may be large with one or more levels of commercial property beneath low-rise or larger medium to high-rise residential developments above.</p>
Integrated housing developments	<p>Mixed-use developments incorporate residential dwellings and commercial establishments within the same development, and include, for example, shop-top housing.</p> <p>Mixed-use developments may be small, for example, two storeys incorporating a residential property on the top floor and commercial outlet on ground level; or they may be large, with one or more levels of commercial property beneath low-rise or larger medium- to high-rise residential developments above.</p>



## Links to other planning requirements

The guide's principles and objectives should be considered alongside the *State Planning Policy Framework* and relevant local planning policies. Clause 19.03-3 of the *State Planning Policy Framework* requires that planning and responsible authorities take into account the *Design Guidelines for Higher Density Residential Development* when making decisions under the planning scheme. Objective 4.6.1 of these guidelines sets out design principles to be considered in the provision of waste disposal for all developments.

This guide provides guidance on matters not fully addressed in planning controls, however it does not supersede state and local planning control requirements. When designing a development, consult with council staff, e.g. engineers, planners and waste managers, regarding specific requirements for facility design and placement in accordance with local requirements.

Poor design decisions can have serious repercussions for the management of the building throughout its lifetime. This can occur with waste management when a failure to address on-site management and collection of garbage and recycling can severely hamper servicing options.

Developers should complete and submit a waste management plan (including plan drawings) to council at the start of the MUD planning process to enable good design, operation and ongoing management of recycling and garbage to be considered as part of the planning for the overall development.

The waste management plan should address how a safe and workable collection system will be provided. In particular, it should detail:

- the maximum number of occupants to be housed, and the number of units
- the estimated volumes of garbage and recyclables that will be generated
- the equipment to be used and collection service requirements, including collection frequency and provider
- the location of, proximity and space allocated to the storage areas for garbage and recyclables
- the path of access for both users and collection vehicles
- how noise, odour and litter will be managed and minimised
- approved facilities for washing bins and bin storage areas
- measures to protect waste equipment from theft or vandalism
- how bin storage areas will be screened and designed to blend in with the rest of the development
- the ongoing management and maintenance of the garbage and recycling systems (and green organics if appropriate), including the responsibility for each stage of the waste management process and arrangements for cleaning of bin storage areas and equipment
- how tenants and residents will be informed of the waste management arrangements (needs to be regular)
- any effects on adjacent properties such as noise.

The waste management plan should be completed by an approved independent professional such as a waste management engineer or waste management planner and be approved by the council waste manager or other delegated officer to ensure health issues such as space, access, amenity, and occupational health and safety (OH&S) are addressed. Council local laws and/or by-laws also need to be considered.



# Introduction

Guide to Best Practice for Waste Management in Multi-unit Developments

## Strategic context

The Victorian Government's *Sustainability in Action: Towards Zero Waste Strategy* sets priorities for waste and resource management in Victoria to 2014. The strategy:

- identifies the need to increase the resource recovery rate from the municipal sector to 65% by 2014
- identifies increased recovery of resources for recycling, and improved waste management systems and infrastructure as a guiding objective for local government
- encourages local government to review planning processes to ensure recycling is supported in the design of new residential buildings.

The *Metropolitan Waste and Resource Recovery Strategic Plan* released in 2009 identifies waste minimisation and resource recovery as key elements. The initiatives identified include the provision of collection services for existing and future high-rise dwellings, especially in light of the intention for further high-density development outlined in Melbourne 2030 which will “necessitate planning approval processes that require appropriate provision for recycling services, and new approaches by developers”.

Sustainability Victoria has developed this guide to stand alongside the existing *Guide to Preferred Service Standards for Kerbside Recycling in Victoria*.

## What is my role?

Figure 1.1 provides an overview of how the guide fits into the overall development process and the various roles and responsibilities of key stakeholders.

**Note:** this is a simplified representation of the development application, approvals and construction process. Contact council for detailed information about each of these stages.

**Figure 1.1 Getting it right – who's responsible**

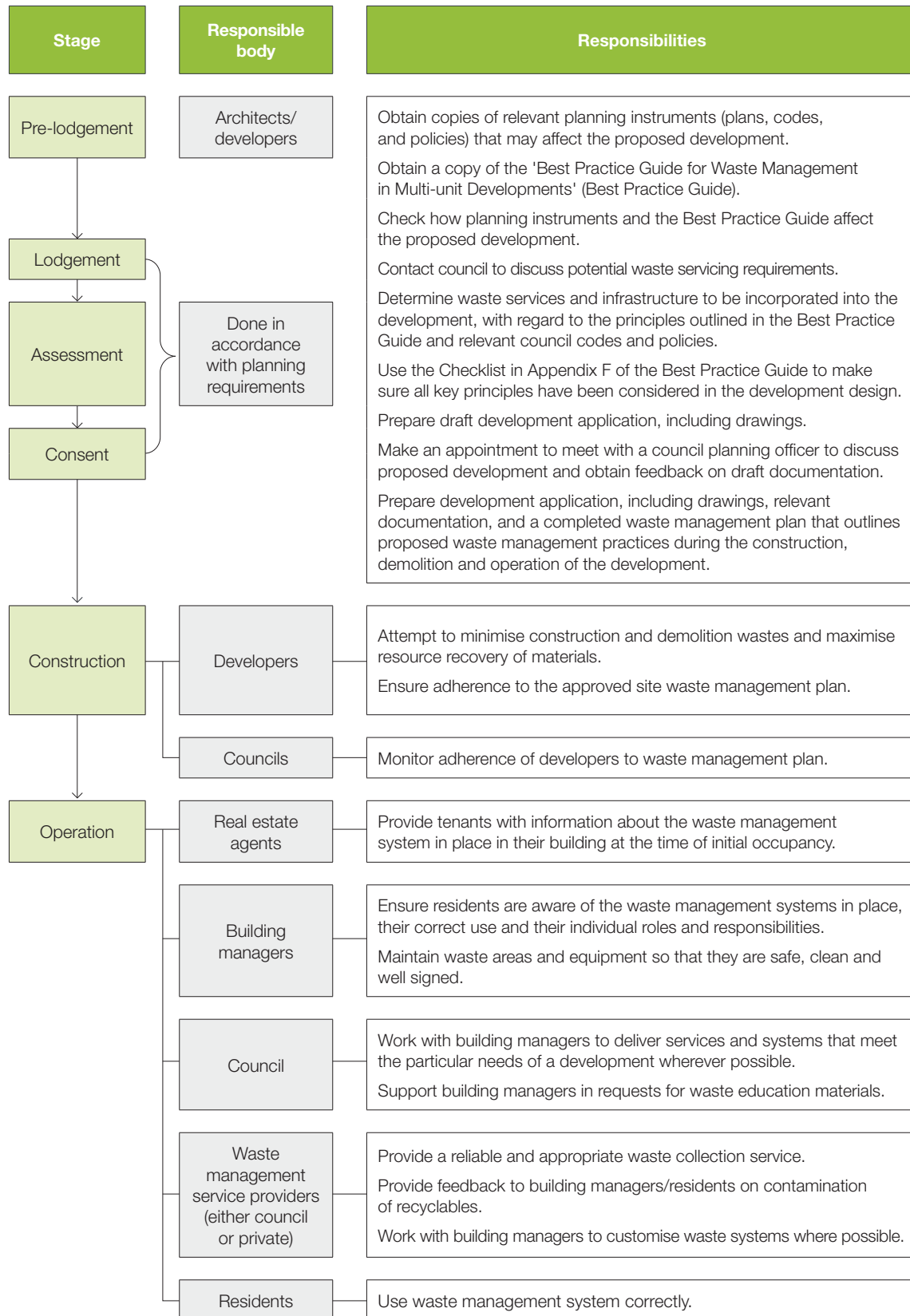

# Introduction

Guide to Best Practice for Waste Management in Multi-unit Developments

## How to use this guide

While the guide is a stand-alone information resource, it was specifically developed to assist architects and developers to effectively plan and design appropriate garbage, recycling and organics management systems and facilities for MUDs.

To use the guide:

1. Read Chapter 2 for the essential requirements applicable to all types of development.
2. Read the chapter that corresponds to the development type (i.e. choose from Chapters 3 to 8 as applicable).
3. Refer to the appendices as required.

The appendices include information, tools and resources to support putting the guide and its principles into practice.

Appendix	Description
<b>Appendix A</b> Waste Generation Rates	Provides information on domestic and commercial garbage and recycling rates to estimate the likely garbage and recycling generation for the development. Also includes examples of how to calculate bin storage area requirements.
<b>Appendix B</b> Waste Management Equipment	Provides dimensions for crates, bins, worm farms and compost bins. Also includes an overview of the operation of chutes, compactors, in-sink disposal units, and other garbage and recycling handling equipment.
<b>Appendix C</b> Collection Vehicles	Provides dimensions of waste collection vehicles commonly used for domestic waste collections from MUDs.
<b>Appendix D</b> Vehicle Access/Turning Circles	Provides information on vehicle access requirements, including road and driveway construction and geometry, and vehicle turning circles and manoeuvring requirements.
<b>Appendix E</b> Standard Signage	Provides information on standard signs that should be displayed in waste rooms and on bins.
<b>Appendix F</b> Checklist	Includes a checklist to check if proposed facilities have been designed in accordance with best practice principles, and to highlight issues of concern.

# 2

All Developments

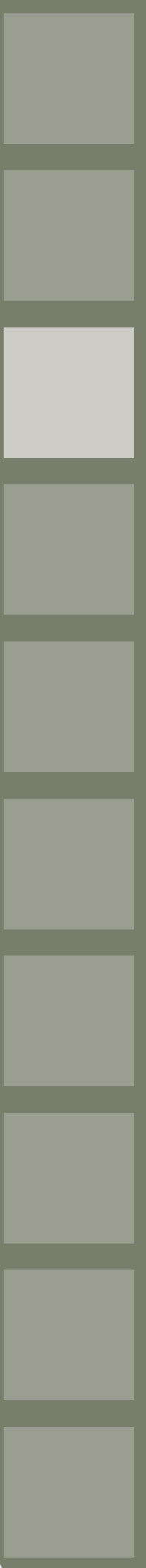
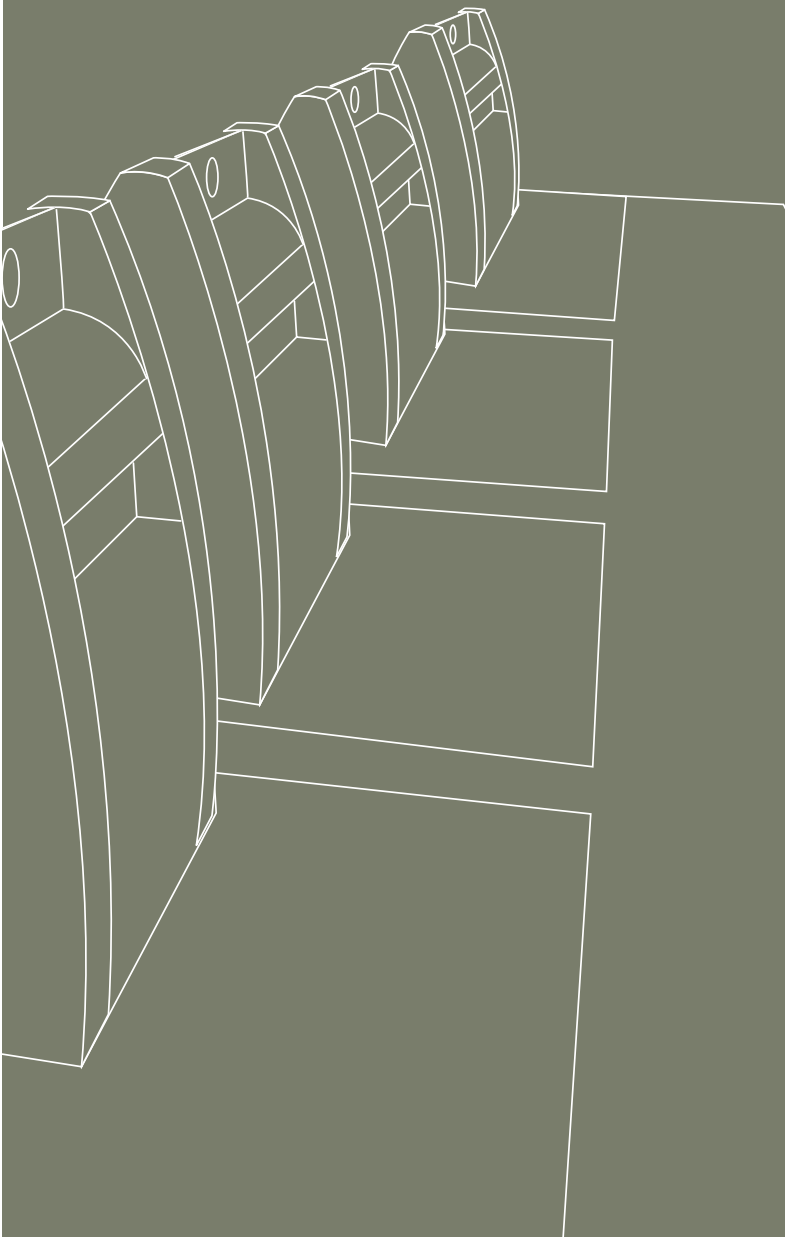

This chapter discusses issues that apply to all development types and should be considered when designing garbage and recyclables management systems.

Please note that the checklist in Appendix F helps to ensure that these key issues have been considered in the building design. Use the checklist to ensure that proposed garbage and recycling facilities have been designed in accordance with best practice principles.

**Remember, this guide does not supersede state and local planning control requirements. Consult with council engineers, planners and waste managers regarding specific requirements for facility design and placement in accordance with local requirements.**

The underlying principles that were used to develop this guide are:

- hygiene, safety and cleanliness are a priority
- systems should be as simple as possible to use
- some systems, particularly in high-rise blocks, require a caretaker or manager
- systems should aim to maximise source separation and recovery of recyclables.

## Council service provision

Local government has an obligation to provide domestic waste management services, but services vary between local government areas. It is therefore imperative to consult early on with council engineers, planners and waste managers regarding specific requirements and options for waste services in the local area to achieve best practice.

Note that the *Victorian Local Government Act 1989* requires councils to levy an annual charge for providing domestic waste management services on all parcels of rateable land for which the service is available, whether or not the service is actually used.

## Risks to health and safety associated with the handling and disposal of waste and recycled material

Waste management systems and services should be designed and operated to prevent the potential risk of injury or illness associated with the collection, disposal or recycling of material. This includes risk to:

- residents using the service
- building management and cleaning staff (if applicable) who maintain the service
- collection staff providing the service
- other people engaged in or affected by the system.

The designer, developer and operator therefore have an important role in considering the potential impact of the design on the ability of others to make collections and provide services in a safe manner.

Collection methods and systems used for waste management in multi-unit developments (MUDs) must comply with the *Occupational Health and Safety Act (2004)* and associated regulations. The *Occupational Health and Safety Guidelines for the Collection, Transport and Unloading of Non-hazardous Waste and Recyclable Materials* should be referred to when designing waste facilities for MUDs. The code provides guidance on how to prevent injury and illness caused by the collection of domestic waste and highlights examples of common hazards and risk control measures.

Irrespective of the size of the development, all services to MUDs must comply with occupational health and safety (OH&S) requirements. A preliminary risk and hazard analysis should be done during the design phase to identify potential risks to health and safety associated with the proposed services and design layout. This will assist in the early identification of risks, thus enabling modification of the proposed design to preferably eliminate, or minimise, the consequence or likelihood of human injury or damage to property and equipment.



# All Developments

Guide to Best Practice for Waste Management in Multi-unit Developments

## Examples of design considerations to help eliminate or control risks

- Adequate storage space for easy manoeuvring of bins within the property, and to and from the storage area to the collection point
  - An appropriate collection point that is free from obstacles and traffic hazards
  - Sufficient space to accommodate required disposal capacity so that bins do not become overloaded or overcrowded
  - Paths for movement of bins of an appropriate grade and free from steps
  - Collection points that enable the mechanical pick-up of bins
- 
- Collection points that are easily accessible for the collection vehicle and have appropriate overhead clearances, strength, width and geometric design
- 
- Areas that are maintained so that all garbage and recycling is contained within appropriate bins
  - Education programs that address safe and appropriate sorting/disposal
- 
- Adequate turning space for vehicles, in particular to avoid the need to reverse
  - Vehicle access and turning areas that are free from obstacles that may impair driver visibility

Further hazards and risks, and appropriate management strategies, should be identified through a risk assessment and considering the recommended design standards included in this guide.



## Access to garbage and recycling bins

**Recycling bins should never stand alone; they should always be sited with garbage bins.**

Waste management systems provided to different developments may vary and be negotiable. In general, however, each development should be provided with access to garbage and recycling services. If there is little garden area and/or a contractor maintains the garden, the council may waive the garden organics service for a particular development.

The disposal of garbage and recyclables should be equally convenient for all residents. Recycling facilities should be located

adjacent to garbage facilities and should never stand alone. Although located near each other, garbage and recycling bins should be kept separated within the storage area and not intermingled.

Systems provided should be convenient, simple to use and as intuitive as possible, i.e. obvious to the uninformed resident, to maximise recycling and minimise contamination.

## Bins and containers

All garbage, recyclables and garden organics generated by a development need to be stored in the appropriate waste bins or containers with permanent, well-fitting lids.

Waste bins and containers used should conform to the Australian Standard for mobile waste containers (AS 4213) if the standard is applicable for the selected bin or container type. Waste bins and containers greater than 1700L should be designed to appropriate safety and other requirements.

Containers should be provided to residents that can be stored within dwellings and used to transport recyclables to the storage area or disposal point. Ideally, a requirement to return containers could form part of the rental agreement.

Ownership should be encouraged by writing unit numbers on individual bins when they are provided for individual units.

Refer to Appendix B for further detail on waste bins and containers.

## Waste handling equipment

Waste handling equipment, including chutes and compactors, should conform to the relevant design and safety standards.

Refer to Appendix B for further information on waste handling equipment.

# All Developments

Guide to Best Practice for Waste Management in Multi-unit Developments

## Storage

### Storage space

#### Inside the dwellings

Sufficient space within the kitchen, or other convenient location, should be provided in each dwelling for interim storage of at least two days' worth of garbage and recyclables.

Space should allow for separate storage of recyclables from the garbage stream and, ideally, for the segregation of food organics in a separate waste container.

#### Bin storage areas

**Provision of adequate storage areas both within and external to dwellings is a key element of best practice systems.**

Storage space for bins is an ongoing issue, particularly in existing premises. Adequate space for the storage of bins should be provided as part of any residential development.

Individual bins should be provided to each property if there is sufficient street frontage and on-site storage space. If street frontage and on-site storage space is limited, garbage and recycling bins should be shared between

units. The number of bins shared between units is based on the amount of garbage and recyclables generated by the residents. The recommended allowance for garbage and recyclables generation is:

- garbage: 60–120L per household per week
- recyclables: 60–120L per household per week

Once bins are shared, a central storage area is required; however, some developments may need more than one central area. Placing a central storage area in existing developments may affect parking and open space. Therefore, consider increasing the frequency of collection or using skip bins, which can reduce the amount of space required.

Whatever the specific arrangements, the building design needs to incorporate sufficient space within the property boundary to store, in separate bins or containers, the volume of garbage and recycling (and garden organics if appropriate) likely to be generated at the development during the period between collections. There should also be space allowed for signs and educational materials to be located adjacent to bins and equipment.

To assess the storage requirements, consider the generation rates (refer to Appendix A), the storage equipment to be used (refer to Appendix B) and the type of service offered. It is essential to provide an adequate area to enable garbage, recyclables and organics bins to be kept separated within the storage area and not intermingled. However, bin storage areas that are too large may actually encourage dumping of bulky items.

The storage area should be designed for easy access and manoeuvring of bins to allow easy cleaning of the storage area, and for maintenance and servicing requirements. It is undesirable to locate other services and appliances, such as electrical meter boards, gas meters or conduits, in bin storage areas, as they may be damaged during collection or cleaning and access for servicing restricted.

The greatest difficulty in calculating space allocation is predicting the collection service that will need to be catered for in the future. Service requirements should be discussed with the local council, but some flexibility needs to be allowed in the building design for the future. Examples of how flexibility can be incorporated in building design include:

- identifying suitable locations for waste storage and collection points that would enable future on-site collection if required
- keeping waste storage areas clear of potential obstacles that would make it difficult to modify existing bin sizes. For example, in communal bin areas, using fixed structures to separate individual bins should be avoided, as bin sizes and/or configurations may change



- designing access paths and doorways greater than the minimum width requirements to allow for possible future changes in bin sizes. For example, installing double doors on a communal garbage area allows easy movement of either mobile garbage bins (MGBs) or bulk bins
- sizing communal bin storage areas to allow for a potential increase in waste generation from the development or a change in allocated council services per dwelling. For example, two bins per dwelling (e.g. for a villa development) to three bins per dwelling.

Refer to Appendix A for examples of layouts for bin storage areas.

## Storage location

Identifying the best location for communal bin storage areas can be difficult, particularly if it has not been incorporated into the original design. It is a balance between convenience to residents and collectors, space, access, noise, security, planning requirements and architectural integration. The following points should be considered when deciding where to locate garbage and recyclables storage areas.

Best practice	Reasons
Location of the bins should be convenient to residents	Conveniently located bins are more likely to be used appropriately by residents.
Bins should be in a high pedestrian traffic area	Locating bins in a high pedestrian traffic area encourages good housekeeping, as the bins are visible to a large number of people. It increases the ease of access and convenience to residents, as disposing of garbage and recyclables can occur as part of the daily routine of walking to the mail box or entering the parking area.  Bins located in a rarely frequented area of the property tend to attract dumped rubbish and encourage poor practices.
If collection of bins is from the kerbside, the waste storage areas should be as close to the kerb as possible	Manual moving of bins from storage areas to the collection point should be minimised if possible to reduce potential health and safety risks. A well-located storage area reduces the time required to take bins out for collection and bring them back.
Storage areas should be out of sight or well screened from the street	Bin storage areas should not affect the aesthetics of the development and should blend in with surrounding buildings and landscape.  Locating storage areas out of sight from the road also improves safety. Bin storage areas that are too close to the street can be subject to vandalism.
Storage areas should be located an appropriate distance from dwellings	Locating bin bays and collection points away from residents will reduce the impact of noise during bin use and waste collection. It will also increase amenity through reduced odour impacts.

# All Developments

Guide to Best Practice for Waste Management in Multi-unit Developments

## Contracts

The structure of service contracts plays an important role in ensuring efficient servicing of MUDs. Indemnity and waste service flexibility are two important contract issues to be considered when deciding an appropriate best practice system for a development. It is important to talk to council as early as possible to identify potential servicing issues.

**Requirements for on-site collection vary between council areas. Be sure to check with council regarding the availability of on-site servicing before assuming it is possible.**

## Indemnity

Some councils may provide on-site collection if:

- there is insufficient space on the kerbside to temporarily place bins for waste collection or bins would encroach on the frontage of adjoining properties
- kerbside collection is unsafe
- kerbside collection causes significant traffic disruption
- kerbside collection occurs in an excessively restrictive area
- council considers kerbside collection inappropriate.

Most councils, however, will not enter private property with their vehicles unless indemnity against liabilities, losses, damages and other costs arising from the on-site collection service has been provided. In some council areas, all bins must be presented at the kerb of a public road, and no on-property service is offered at all.

To enable best practice waste management in MUDs, developers should:

- decide the preferred waste management system to install, considering the principles outlined in this guide
- check with council if on-site collection is required or allowed, before submitting the development application
- if on-site collection is required
  - ensure design of facilities can safely accommodate on-site collection
  - liaise with council to find out if it can provide the on-site service
  - identify necessary indemnity arrangements.

## Service flexibility

The design of the waste management system should accommodate services provided by council if possible. Some councils may only be able to offer MUDs the same (or similar) services as those offered to single dwellings. Often, particularly for medium- to high-rise developments, the efficient provision of cost-effective garbage and recycling collection services for MUDs may require using an alternative service option, for example, bulk bins or underground systems.

To enable best practice waste management in MUDs:

- Designers/developers should check with council about the garbage and recycling service options available and whether they are suitable for the proposed development.
- Councils should seek a best practice contract structure that provides for variations to services during the agreed contract period.



## Contract structure

In addressing council servicing of MUDs, the structure of recyclables collection and sorting contracts needs to be addressed. It is also recognised that some councils use in-house collection contracts rather than separate contractors. Traditionally, kerbside recycling collections are based on a per household collection cost, with one bin per household. It may be preferable to use another format at sites where the number of households is high and the sharing of bins occurs.

Best practice contract structure for recycling services in MUDs should consider:

- the most relevant basis for calculating servicing costs, e.g. per household or per bin lift
- different contract requirements for multi-occupancy residential sites relative to detached housing
- the expansion of multi-occupancy residential sites over the life of a contract, including increased use of skips
- clear definition of contract responsibilities
- the use of smaller vehicles in specific areas
- performance standards and key performance indicators.

## Collection point

### Location of collection point

Identify a suitable waste collection point and discuss collection requirements with the council.

#### General requirements

Collection points, if possible, should **not** be located:

- near intersections
- near roundabouts or slow-points
- along busy arterial roads
- in narrow lanes
- where bins may restrict pedestrian access
- where parking will restrict access to bins
- near possible obstructions, including trees, overhanging buildings and overhead power lines
- where they pose a traffic hazard.

**Collectors need to be able to move the bins as quickly as possible, preferably with no manual handling.**

The collection point(s) should enable collection operations to be carried out on a level surface, away from gradients and vehicle ramps.

If MGBs will be used and collected from the kerb, there should be sufficient space on the street for them to be lined up neatly in (preferably) a single row along the kerb. Remember, cars parked along the street and bins placed two or more rows deep are an obstacle for safe and efficient kerbside collection, as they require collection operators to get out of the collection vehicle and manually move bins to an appropriate position for collection. They also create amenity issues for residents, can impede pedestrian access and can be a traffic hazard for motorists.

Identifying a suitable collection point is particularly important for servicing developments if there are a large number of bins to be collected, there is limited direct access to the development (for example, battleaxe block developments with minimal frontage), or if the development has specialised servicing requirements due to equipment used to provide the waste service. For example:

- The collection point for bulk bins or bins containing compacted waste should be located so the bins can be accessed with minimal manual handling.
- Underground systems require suitable access for the collection vehicle to enable safe lifting of the underground containers for servicing (including clearance for lifting arm).

Developers should consider what alternatives are available for locating collection points, particularly for developments built on small blocks with steep gradients, to enable safe presentation and uplift of bins.

# All Developments

Guide to Best Practice for Waste Management in Multi-unit Developments

## On-site collection

Some councils will not enter private property to make collections, or will only do so if an indemnity has been provided.

It is important to confirm potential arrangements for on-site collection with the council before assuming that it will be possible. If an agreement for on-site collection is made, the on-site collection points should be located:

- so that collection vehicles minimise interference with the use of access driveways, loading bays or parking bays during collections
- close to waste storage facilities to permit easy transfer of bins to the collection point, if relocation of bins is required
- in a relatively flat area and on the same level as the collection vehicle (i.e. bins should not be placed for collection on elevated loading bays or nature strips/footpaths)
- to provide collection vehicles safe access to the collection point and adequate clearance and manoeuvring space
- so oncoming traffic can be clearly seen as the collection vehicle leaves the property.

## Manoeuvring bins to the collection point

If relocation of bins of up to 360L in capacity is required:

- the distance from each unit should not exceed 50m
- the bin transfer grade should not exceed 1:14

If relocation of bins greater than 360L capacity is required:

- bins should not need to be wheeled up or down steps
- if less than or equal to 1.0m<sup>3</sup> in capacity, bins should not need to be wheeled more than 5m from the interim storage point to the collection point
- if greater than 1.5m<sup>3</sup> in capacity, manual manoeuvring of bins should be avoided wherever possible. If it cannot be avoided (for example, if bins are stored in a room or enclosure), the bins should not need to be wheeled more than 3m from the interim storage point to the collection point
- the bin-transfer grade should not exceed 1:30.

In all cases, bins should not need to be wheeled up or down steps.

## Access for service providers

**Wherever possible, waste collection vehicle movement should be in a forward direction with no need to reverse.**

Inadequate kerbside frontage space is a key issue in providing kerbside garbage and recycling services to MUDs. The placement of bins at the kerbside can have a significant impact, particularly in areas of high density.

If the number of bins placed out for collection is too great for the width of the street frontage, bins can end up stacked one behind the other. This creates amenity issues for residents, accessibility issues for pedestrians and can be a traffic hazard for motorists. It also requires

bins to be manually wheeled to the collection vehicle to enable mechanical collection by a side loader. Curved roads may also pose a problem (particularly in residential street courts); if possible, place bins where the road is straight.

Specific access requirements for collection vehicles will vary slightly from council to council, depending on the waste collection arrangements. However, collectors always need to be able to move bins from the collection point to the vehicle as quickly as possible, preferably with no manual handling. Note that requirements for manual handling may differ between councils and respective collection contracts.

Whatever bin type is used, the developer needs to ensure there is sufficient space for the collection vehicle to drive to the collection point, empty the bin and safely leave the collection point. Wherever possible, collection vehicle movement should be in a forward direction with no need to reverse.

The design aspects to take into account for vehicle access include:

- the presence of parked cars on access roads
- heavy vehicle access and turning circle requirements (refer to Appendix D)
- collection vehicle overhang and possible interference with bins, street furniture and trees
- clearance height for servicing, particularly when developments are serviced internally, or if an external collection point is near trees or overhead obstacles.

## On-site collection

If a collection vehicle is required to drive onto a private road or private property, the driveway and road need to be suitable for the collection vehicle in terms of strength, width, geometric design and height clearance (refer to Appendix C and D for technical specifications). The access points and collection area should be free from overhead obstacles and of an appropriate gradient. When making an on-site collection from within a building, the clearance height should be clear of any airconditioning ducts, sprinklers or other potential obstructions.

Appropriate heavy vehicle standards should be incorporated into the development design, including those specified in acts, regulations, guidelines and codes administered by Austroads, Vicroads, WorkSafe Victoria and any local traffic requirements.

In addition to the design aspects addressed earlier, general access to the collection point should be considered in the development design and operation. Locked gates and security systems that prevent access to waste collection points can cause serious delays and problems in servicing if not well designed and/or waste collection operators are not provided with the required authority for access. Designers and developers should consider the likely ongoing operational arrangements for access to locked-gate communities and how this needs to be incorporated in the design. For example, some councils may require a set of keys or remote-control access to enter developments, whereas others may require security systems to be compatible with a single master key held by council.

Remember, garbage and recycling collections may occur at different times depending on the local government area and service provider, thus access should not be restricted at any time.

## Presentation area

If the collection of bins from either the normal storage location (inside the property) or a location on the kerbside could cause amenity and safety concerns, some councils may require the use of a “presentation” area. This is an area which acts as an intermediate point between the storage area and collection point, which may be on- or off-site.

If a presentation area is used, a caretaker or other designated person(s) must move the bins from the storage area to the presentation area for collection and return them to the storage area once emptied.

If used, presentation areas should be located as close as possible to the collection point.

Not all council areas support presentation areas; check with council regarding specific local requirements and service options.



# All Developments

Guide to Best Practice for Waste Management in Multi-unit Developments

## Composting

Space could be provided for a home unit worm farm or compost bin to allow residents to compost their own food scraps. Individual worm farms could be located on the balcony, for example.

If the development has a garden area, space could be allocated for a communal compost unit or worm farm. However, experience of communal composting arrangements shows this option should only be considered if there is a caretaker or gardener able to manage the compost unit.

Communal composting areas, if appropriate, should be located considering:

- visibility and accessibility to increase awareness of the compost pile and the need to keep the area well maintained
- the positioning of dwellings (on-site and in adjoining properties)
- their potential to generate odour
- any potential run-off is away from site drainage points.

Refer to Appendix B for size and space requirements of typical compost units and worm farms.

## Noise

The main sources of noise associated with domestic waste collection are emptying glass into bins, emptying glass from bins into the collection vehicle and reversing alarms on collection vehicles.

Best practice approaches to reduce noise include:

- locating bin bays and collection points far enough away from residents to reduce the impact of noise during bin use and waste collection
- minimising the need for collection vehicles to reverse
- selecting appropriate surfacing materials (that will minimise noise) for pathways and driveways that bins will need to be wheeled over
- insulating chutes (the noise associated with waste falling out the bottom of the chute and with compactors can also be problematic and should be dealt with)
- considering how material will be transferred into bins or static compactors at storage points.

**Remember – waste is collected at least once per week. In some areas, waste is collected daily and therefore noise can be a significant concern for residents and those in adjoining properties.**

## Odour

Having a well-ventilated waste storage area is essential to minimise odour problems.

For enclosed storage and service areas, the air flowing from interim storage areas and central garbage rooms should not exit close to units. Ventilation openings should be protected against flies and vermin and located as near the ceiling and floor as possible, but away from the windows of dwellings.

If a forced ventilation or airconditioning system is used (for enclosed storage areas), it should:

- be in accordance with the ventilation requirements of the Building Code of Australia and AS 1668.2 The use of ventilation and airconditioning in buildings
- not be connected to the same ventilation system supplying air to the units.

## Hygiene/vermin

**Remember to locate drains to the sewer undercover to prevent rainwater infiltration.**

Waste not sealed in containers can attract vermin and is unhygienic. Do not allow bins to sit open for long periods of time.

As far as possible, prevent vermin getting into waste collection and storage areas. Keep waste collection and storage areas free of clutter and dumped rubbish.



## Communal bin storage areas

Communal bin storage areas need to be easy to clean, with access to water (a tap and a hose) and correct drainage to the sewer. Never allow the water from washing bins and/or waste storage areas to flow into the stormwater drain.

Ideally, having covered floor junctions at walls helps with cleaning and avoids the build-up of dirt and spills.

To maintain hygiene:

- assign responsibility for keeping communal areas clean
- wash bins, floors and walls of garbage bays and rooms regularly.

## Visual amenity

All waste management facilities (including storage areas) should be adequately screened, not readily visible from any public place and should blend in with the development.

A poorly designed and located bin-storage area can detract from the overall development, encourage misuse of the facilities provided and affect recycling outcomes.

Remember to consult with council engineers, planners and waste managers regarding specific requirements for facility design and placement in accordance with local development codes.

## Security

As far as possible, the design of waste storage areas should allow easy access for residents but not non-residents. One option is to ensure bin storage is out of sight from the road. Another option is to design bin storage areas that can be locked.

Communal bin areas, if used, need to be sufficiently open and well lit to allow their use after dark.

All internal garbage and recycling rooms and storage areas should be designed to comply with the Building Code of Australia, with particular regard to fire prevention provisions.

Equipment also needs to be protected from theft and vandalism.

## Signs and education

Ongoing education, and dedicated ongoing management services, are critical factors in encouraging residents to continue to use services and systems as intended.

Educational materials like signs not only provide clear instructions on what materials can be collected for recycling and where they go, but provide reasons as to why it is important to sort material for recycling (raise awareness and perceived importance of resource recovery and the environment).

Ensuring education is ongoing is beneficial because it tackles the fact that residents can be transient and that there are differences between council services.

Display signs in public areas of the building, notably at the communal waste storage and chute areas. Clearly identify and label all bins with signs instructing residents on how to use the facilities and the correct separation of garbage, recyclables and organics. Photos of actual items work best – especially for items that can be recycled. Also clearly identify any hazards or potential dangers associated with the waste facilities, including those from the use of any waste handling equipment.

Information should also be displayed in communal areas that identifies who can be contacted to find out more about the recycling and/or other services in the development.

Refer to Appendix E for further information about standard signs that can be used to support waste facilities and services.

# All Developments

Guide to Best Practice for Waste Management in Multi-unit Developments

## Ongoing management

Ongoing management of waste and recycling systems in MUDs is imperative to maintain amenity; maximise safety for residents, caretakers and collectors; maximise resource recovery; and enable efficient servicing of the development.

Ongoing management is required to monitor resident behaviour and identify requirements for further education and/or signs. Any negative behaviour, such as dumping waste and recyclables on the floor rather than in bins, needs to be addressed quickly. A fast response is desirable to prevent spreading of negative behaviour and to maintain the amenity, access and convenience of services to others.

It is important to establish and delegate responsibility for the tasks involved in ongoing waste management, including:

- moving bins to and from the storage point to the collection point (if required) on collection day
- washing bins and maintaining storage areas
- arranging for the prompt removal of dumped rubbish
- displaying and maintaining consistent signs on all bins and in all communal storage areas
- managing communal composting areas (if applicable)
- ensuring all residents are informed of the garbage, recycling, organics and bulky waste arrangements.

The size of the development will influence the responsibility for ongoing management and maintenance of bins. Active caretakers are recommended for all developments, particularly those with communal storage areas, and are considered vital for effective ongoing management in large (in scale and number of dwellings) developments, whether they be, for example, townhouse, multi-storey or mixed-use developments.

Conditions of consent can require that a development comply with the submitted and approved waste management plan. If a caretaker is required, this should be detailed in the waste management plan; employment of a caretaker will then form part of the conditions of consent, which must be adhered to.

## Costs

Traditionally, servicing of MUDs has been included in councils' overall kerbside collection and sorting contracts.

The cost of servicing MUDs however, may be significantly different to other residential sites. The high concentration of households on the one site can offer a benefit in collection efficiency. MUDs generate less material per household, but often have higher levels of contamination.

There may be a different contract rate required for some developments if a collection vehicle driver has to get out and relocate the bins for collection. This additional cost could be charged back to building owners.

The following cost factors should be considered to achieve best practice:

- potential savings from using static compactors to compress waste into a smaller volume
- on-site management costs by sites
- infrastructure purchase costs
- cost impacts from larger sites providing a non-council contracted private operator and requests for exemptions from council charges
- costs to ratepayers, building managers and developers.

# 3

## Villas and Townhouses

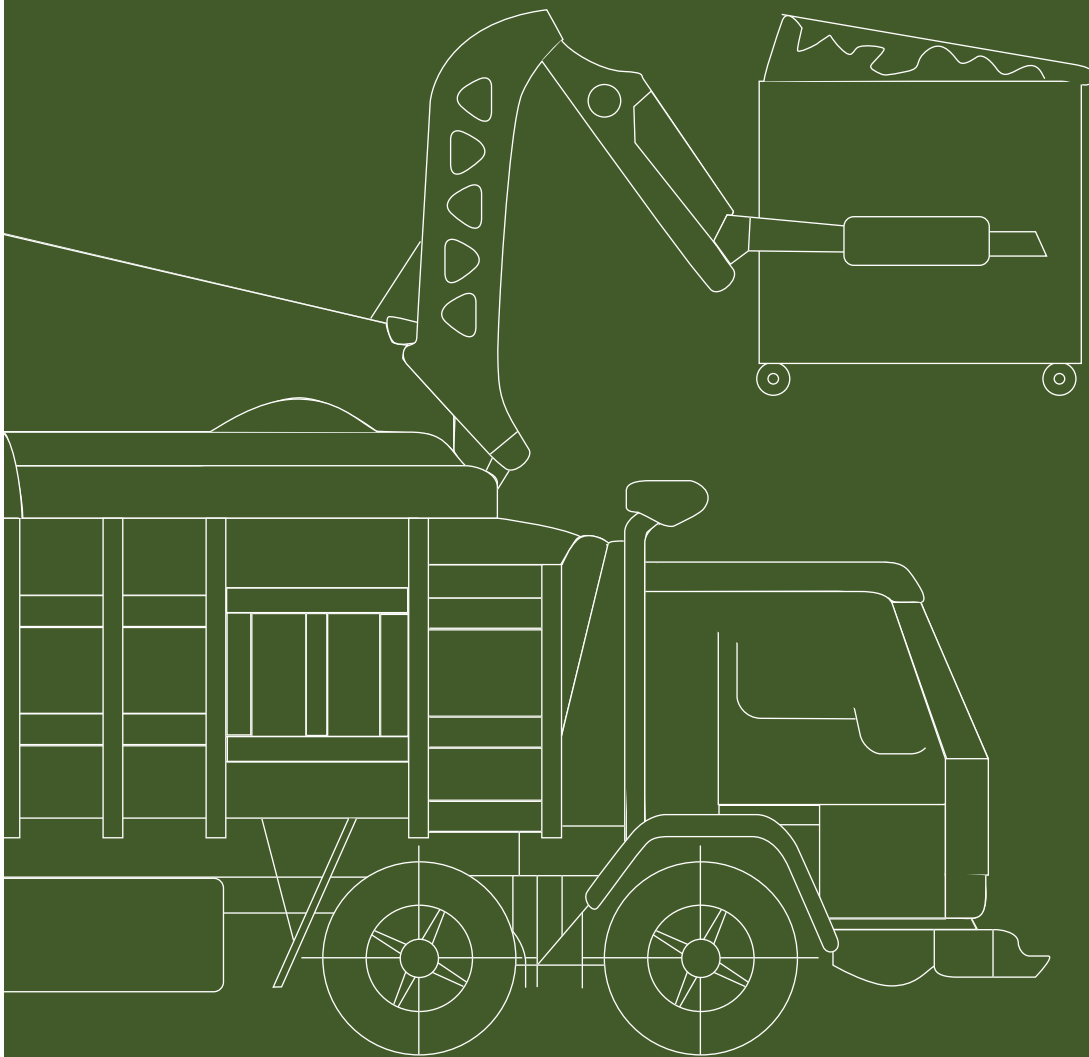



Villas and townhouses are one- to two-storey dwellings, with three or more dwellings on the same parcel of land. Each dwelling often has a small yard and/or car space.

Elements of this development type are also relevant to nursing homes, retirement villages and the residential component of caravan and holiday parks.

## Issues for consideration

The issues discussed in this chapter need to be considered in addition to those applying to all developments as outlined in Chapter 2.

## Best practice garbage and recycling systems and services

When the development is relatively small in scale, villas and townhouses may be treated like separate houses when it comes to council waste services. In this case, each townhouse/villa may have its own bin(s), and residents put their bin(s) on the kerb on collection day. Alternatively, a centralised garbage and recycling enclosure may be used for communal location of bins.

Examples of best practice waste management in villa and townhouse developments include the following.

- **Option 1:** Use mobile garbage bins (MGBs) for garbage and recyclables, with bins stored in each resident's yard or garage.
- **Option 2:** Use MGBs for garbage and recyclables (they could be shared), with bins stored in a communal storage area. A caretaker may need to transfer bins to the collection point and back into the property.
- **Option 3:** Use bulk bins for garbage and either bulk bins or MGBs for recyclables, with all bins stored in a communal storage area. Note: some councils provide bulk bins for garbage and recyclables, such as paper and cardboard; other councils use MGBs for either source-separated or commingled recyclables.

For Option 1, it is recommended that councils provide an 80–120L garbage MGB per dwelling (collected weekly) and a 240L recycling MGB per dwelling (collected fortnightly). Depending on the quantity of garden organics generated, council may or may not offer a garden organics service to these developments.

The key features of the above systems and their advantages and disadvantages are outlined in Table 3.1.

**Note:** these systems are provided as examples only and are not intended to constrain good, workable alternatives.

# Villas and Townhouses

**Table 3.1 Villa and townhouse development – best practice examples**

## Option 1

- MGBs (up to 240L) for garbage and recyclables
- Bins stored in individual yards

Advantages	Disadvantages	System requirements
<p>MGBs are generally easy to manoeuvre.</p> <p>Residents have ownership of bins and are therefore more likely to take greater responsibility for maintaining the system appropriately.</p> <p>Residents move bins to and from the collection point, meaning less time is required by caretaker for ongoing management.</p> <p>Bins may be collected from the kerbside if there is sufficient room to do so safely and efficiently.</p> <p>Simple and easy-to-use for both garbage disposal and recycling.</p> <p>Encourages participation in recycling through co-location of garbage and recycling bins.</p>	<p>A large number of MGBs may be required to service the development. Large numbers of bins placed out for collection on the kerbside can reduce amenity and pose risks to pedestrians from blocking pathways. They also pose a safety risk to collection operators if they need to manually move bins around cars to the waiting collection vehicle.</p> <p>Residents may leave bins at the kerbside for longer than necessary (they are taken out early and collected late), which may cause amenity and safety issues.</p>	<ul style="list-style-type: none"> <li>■ Sufficient space in each yard to store at least three bins (for garbage, commingled recyclables and garden organics) for each townhouse/villa.</li> <li>■ Side or rear access, of suitable grade and distance, to all villas and townhouses.</li> <li>■ Suitable waste collection point(s) for collection of the required number of MGBs that is free from potential obstacles, including parked cars (note, on recycling days there may be twice as many bins placed out for collection).</li> <li>■ Identified responsibilities for educating residents about appropriate use of systems.</li> </ul>



## Option 2

- MGBs for garbage and recyclables
- Communal storage area(s)

Advantages	Disadvantages	System requirements
<p>MGBs are generally easy to manoeuvre.</p> <p>MGBs can be numbered and shared between allocated units. This increases perceived levels of ownership, leading to increased accountability and appropriate behaviour of residents.</p> <p>Bins may be collected from the kerbside if there is sufficient room to do so safely and efficiently.</p> <p>Simple and easy-to-use for both garbage disposal and recycling.</p> <p>Encourages participation in recycling through co-location of garbage and recycling bins.</p>	<p>A large number of MGBs may be required to service the development. This would require a large storage area (or several smaller areas), and considerable time for ongoing management, including cleaning bins, and moving bins in and out from the collection point.</p> <p>Large numbers of bins placed out for collection on the kerbside can reduce amenity and pose risks to pedestrians from blocking pathways. They also pose a safety risk to collection operators if they need to manually move bins around cars to the waiting collection vehicle.</p> <p>Recycling bins could be contaminated if there is an inadequate number of MGBs for garbage.</p>	<ul style="list-style-type: none"> <li>■ Storage areas that provide easy access for residents and caretakers to all MGBs without the need to move bins.</li> <li>■ Suitable waste collection point(s) to collect the required number of MGBs that is free from potential obstacles, including parked cars (note, on recycling days there may be twice as many bins placed out for collection).</li> <li>■ Identified responsibilities for cleaning communal areas and bins, educating residents in the appropriate use of systems and for moving bins in and out of the storage area for collection – engaging a dedicated caretaker is recommended.</li> <li>■ Clear signs indicating appropriate use of recycling systems.</li> <li>■ Adequate garbage capacity to reduce possible contamination of recycling bins.</li> </ul>

# Villas and Townhouses

Guide to Best Practice for Waste Management in Multi-unit Developments

## Option 3

- Bulk bins for garbage and either 240L MGBs or bulk bins for recyclables
- Communal storage area(s)

Advantages	Disadvantages	System requirements
<p>Could reduce footprint required for bin storage area.</p> <p>Could improve amenity compared with having a larger number of MGBs to service.</p> <p>Simple and easy-to-use for both garbage disposal and recycling.</p> <p>Encourages participation in recycling through co-location of garbage and recycling bins.</p>	<p>Decreased ownership may result from sharing bins between greater numbers of units.</p> <p>Bulk bins can be heavy when full and pose a serious health and safety risk if they have to be manually moved.</p> <p>Bulk bins for garbage can discourage waste minimisation.</p> <p>Access for safe and efficient emptying of bulk bins may be limited.</p> <p>On-site collection is generally required for bulk bins, which may not be available in some local areas.</p> <p>Recycling bins could be contaminated if there is an inadequate disposal capacity for garbage.</p> <p>Potentially, there could be higher contamination of recyclables if collected in bulk bins.</p> <p>Bulk bins are generally suitable for paper and cardboard collection, but not commingled recyclables or source-separated glass due to glass breakage and safety issues during collection.</p>	<ul style="list-style-type: none"> <li>■ Storage areas that provide easy access for residents and caretakers to all MGBs without the need to move bins.</li> <li>■ A design that enables efficient on-site collection of bulk bins.</li> <li>■ Suitable waste collection point(s) for collection of bulk bins to eliminate or minimise manual handling as appropriate (refer to general requirements in Chapter 2).</li> <li>■ Identified responsibilities for cleaning communal areas and bins, educating residents in the appropriate use of systems and for moving bins in and out of the storage area for collection (could address in waste management plan).</li> <li>■ Clear signage indicating appropriate use of recycling systems.</li> <li>■ Adequate garbage capacity to reduce contamination of recycling bins.</li> </ul>

## Applicable for Options 2 and 3

### Storage – space and location of communal bin areas

Storage of waste bins may be in either one or more communal areas, including:

- external enclosures, such as a bin bay
- enclosures located at ground floor parking level, within the building undercroft
- rooms located within the main building or basement.

Large-scale villa and townhouse developments may be spread across a large area, which could have dual or multiple street frontages; therefore, consider incorporating more than one communal storage area.

### Garbage and recyclables collection point

If there is more than one communal storage area, it may be appropriate to have more than one waste collection point for servicing the development (subject to street frontage and access).

For MGB-based waste collection systems, the waste collection point is typically from the kerb. The collection point for bulk bins should meet the general requirements specified in Chapter 2.



## Example diagrams

The following figures provide examples of the possible location of bin storage areas for villas and townhouses. These examples are a guide only, many other arrangements could be suitable and in accordance with best practice principles. Remember to consult with council engineers, planners and waste managers regarding development requirements specific to a local area.

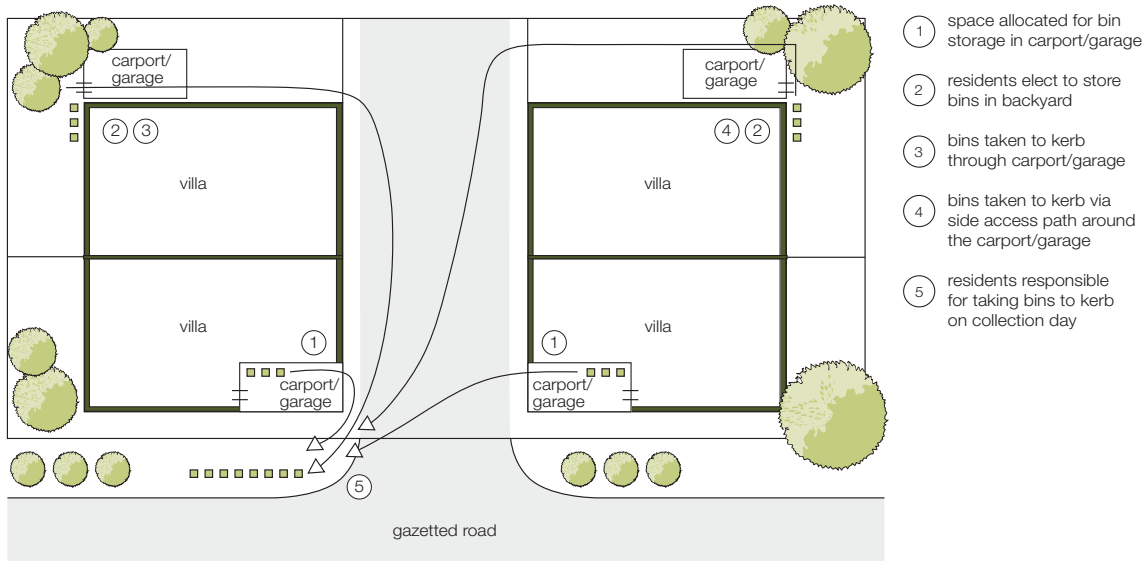

**Figure 3.1 Example of Option 1: bins stored within each individual yard**

This example demonstrates different bin storage locations that are possible for villas and townhouses if bins are stored within each individual property. Bins are collected from the kerbside, with residents moving bins to and from the collection point on the collection day.

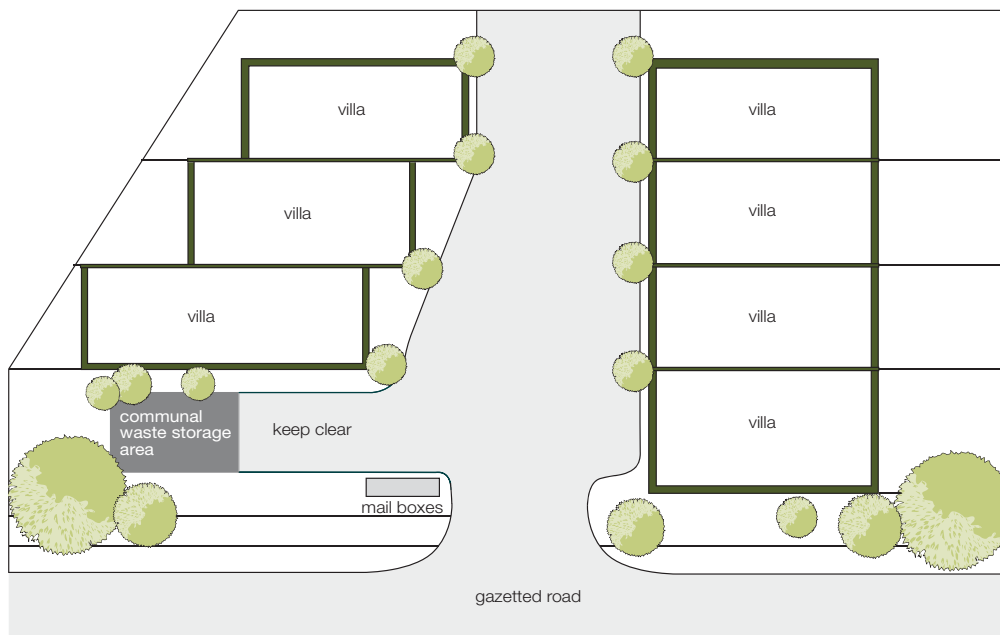

**Figure 3.2 Example of Option 2: communal storage area for MGBs**

This example demonstrates the possible location of a communal storage area servicing a villa complex. Residents take garbage and recycling to the communal storage area, which is conveniently located at the front of the property near the entrance to the development. A caretaker or designated resident(s) may transfer bins from the communal storage area to and from the kerbside collection point on collection day, or there may be an arrangement in place for on-site servicing.

# Villas and Townhouses

Guide to Best Practice for Waste Management in Multi-unit Developments



**Figure 3.3 Example of Option 3: communal storage area for bulk bins and MGBs**

*This example demonstrates the possible location of a communal storage area servicing a villa complex that enables the on-site collection of bulk bins. Residents take garbage and recyclables to the communal storage area, which is conveniently located at the front of the property near the entrance to the development.*

*A caretaker or other designated person(s) may transfer recycling MGBs from the communal storage area to and from the kerbside collection point on collection day, or there may be an arrangement in place for on-site servicing. The bulk bins used for garbage collection are collected on-site, with there being sufficient space for the collection vehicle to safely access the collection area, and then to reverse within the property so the vehicle could leave in a forward direction.*

# 4

## Low-Rise Developments

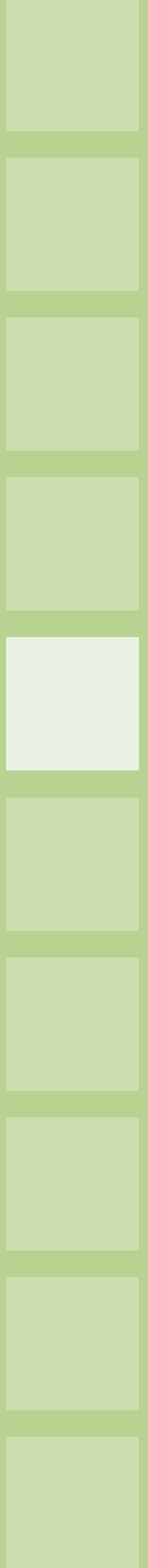
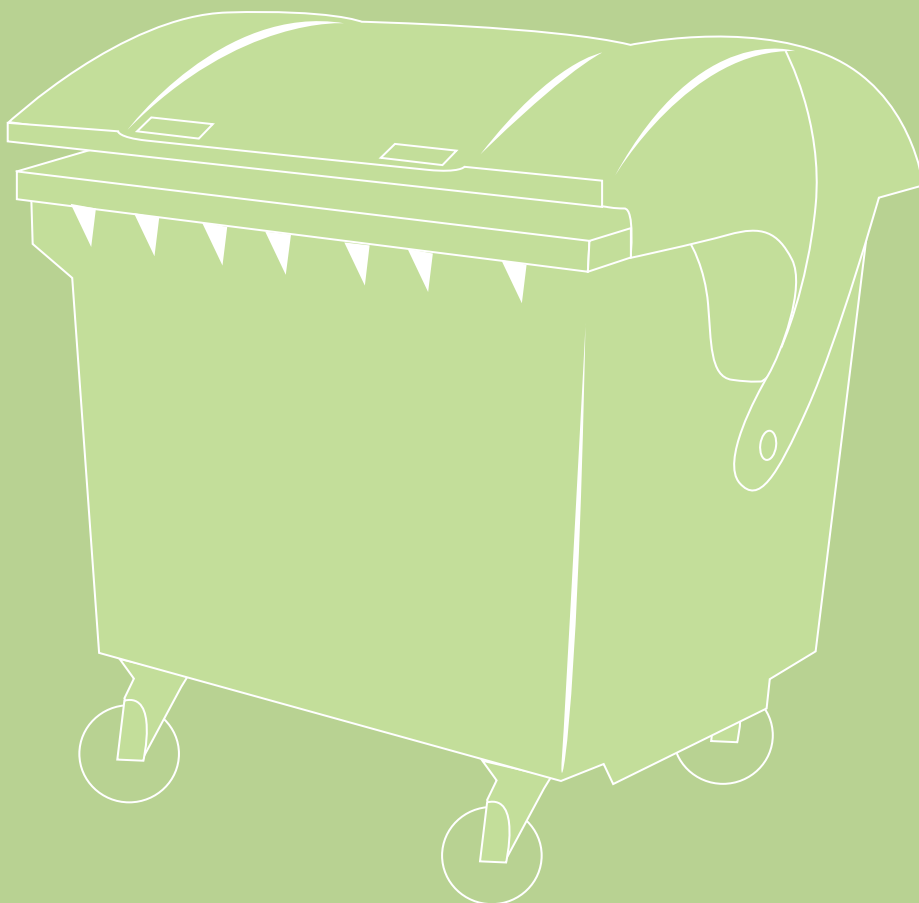



Low-rise developments include two- to three-storey “walk-ups” – small blocks of units (e.g. 4–12 units), with separate dwellings on each storey. They are called walk-ups because they are not required to have a lift and access to upper storeys is by stairs.

Elements of this development type are also relevant to the residential component of hotels and serviced units.

## Issues for consideration

The issues discussed in this chapter need to be considered in addition to those applying to all developments as outlined in Chapter 2.

## Best practice garbage and recycling systems and services

Examples of best practice waste management in low-rise developments include:

- **Option 1:** Use of mobile garbage bins (MGBs) for garbage and recyclables, with bins stored in a communal storage area. Council’s waste management unit will be able to advise what the allocation of bins will be. However, a rule of thumb is one 240L bin of each type (i.e. garbage, recycling) shared per two units.
- **Option 2:** Use of bulk bins for garbage and either bulk bins or MGBs for recyclables, with all bins stored in a communal storage area. Note: some councils provide bulk bins for garbage and recyclables, such as paper and cardboard; other councils use MGBs for either source-separated or commingled recyclables.

The main features of the above systems and their advantages and disadvantages are outlined in Table 4.1.

**Note:** these systems are provided as examples only and are not intended to constrain good, workable alternatives.

# Low-Rise Developments

**Table 4.1 Low-rise development – best practice examples**

## Option 1

- 240L MGBs for garbage and recyclables
- Communal storage area(s)

Advantages	Disadvantages	System requirements
<p>MGBs are generally easy to manoeuvre.</p> <p>MGBs can be numbered and shared between allocated units. This increases perceived levels of ownership, leading to increased accountability and appropriate behaviour of residents.</p> <p>Bins may be collected from the kerbside if there is sufficient room to do so safely and efficiently.</p> <p>Simple and easy-to-use for both garbage disposal and recycling.</p> <p>Encourages participation in recycling through co-location of garbage and recycling bins.</p>	<p>A large number of MGBs may be required to service the development. This would require a large storage area (or several smaller areas), and considerable time for ongoing management, including cleaning bins, and moving bins in and out from the collection point.</p> <p>Large numbers of bins placed out for collection on the kerbside can reduce amenity and pose risks to pedestrians from blocking pathways. They also pose a safety risk to collection operators if they need to manually move bins around cars to the waiting collection vehicle.</p> <p>Recycling bins could be contaminated if there is an inadequate number of MGBs for garbage.</p> <p>Accountability for appropriate use of recycling bins is diminished when bins are stored in communal areas.</p>	<ul style="list-style-type: none"> <li>■ Storage areas that provide easy access for residents and caretakers to all MGBs without the need to move bins.</li> <li>■ Suitable waste collection point(s) to collect the required number of MGBs that is free from potential obstacles, including parked cars (note, on recycling days there may be twice as many bins placed out for collection).</li> <li>■ Identified responsibilities for cleaning communal areas and bins, educating residents in the appropriate use of systems and for moving bins in and out of the storage area for collection.</li> <li>■ Clear signs indicating appropriate use of recycling systems.</li> <li>■ Adequate garbage capacity to reduce contamination of recycling bins.</li> </ul>



## Option 2

- Bulk bins for garbage and either 240L MGBs or bulk bins for recyclables
- Communal storage area(s)

Advantages	Disadvantages	System requirements
<p>Could reduce footprint required for bin storage area.</p> <p>Could improve amenity compared with having a larger number of MGBs to service.</p> <p>Simple and easy-to-use for both garbage disposal and recycling.</p> <p>Encourages participation in recycling through co-location of garbage and recycling bins.</p>	<p>Decreased ownership may result from sharing bins between greater numbers of units.</p> <p>Bulk bins can be heavy when full and pose a serious health and safety risk if they must be manually moved.</p> <p>Access for safe and efficient emptying of bulk bins may be limited.</p> <p>On-site collection is generally required for bulk bins, which may not be available in some local areas.</p> <p>Recycling bins could be contaminated if there is an inadequate number of MGBs for garbage.</p> <p>Potentially, there could be higher contamination of recyclables if collected in bulk bins.</p> <p>Accountability for appropriate use of recycling bins is diminished when bins are stored in communal areas.</p> <p>Bulk bins are generally suitable for paper and cardboard collection, but not commingled recyclables or source-separated glass due to glass breakage and safety issues during collection.</p>	<ul style="list-style-type: none"> <li>■ Storage areas that provide easy access for residents and caretakers to all MGBs without the need to move bins.</li> <li>■ A design that enables efficient on-site collection of bulk bins.</li> <li>■ Suitable waste collection point(s) for collection of bulk bins to eliminate or minimise manual handling as appropriate (refer to general requirements in Chapter 2).</li> <li>■ Identified responsibilities for cleaning communal areas and bins, educating residents in the appropriate use of systems and for moving bins in and out of the storage area for collection.</li> <li>■ Clear signs indicating appropriate use of recycling systems.</li> <li>■ Adequate garbage capacity to reduce contamination of recycling bins.</li> </ul>



# Low-Rise Developments

Guide to Best Practice for Waste Management in Multi-unit Developments

## Storage – space and location

### Communal bin areas

Waste bins may be stored in either one or more communal areas, including:

- external enclosures, such as a bin bay
- enclosures located at ground floor parking level, within the building undercroft
- rooms located within the main building or basement.

Low-rise developments may be spread across a large area, encompassing several different blocks within a single development. Therefore, consider incorporating more than one communal storage area within the development.

### Bulky items storage

Consider allowing space, adjacent to the waste storage area, for residents to temporarily store unwanted bulky items while awaiting disposal. This is important to stop residents illegally dumping this material on the footpath, which detracts significantly from the quality and appearance of the development.

In allocating storage space for bulky items, the intended frequency of collection should be considered. Bulky items may be collected by council or contractors. Alternatively, tenants or building managers may make arrangements themselves.

It is important to check the details of a council-provided service, as the frequency and the types and sizes of materials collected may differ from one council to another.

If on-site collection is not available, a caretaker should be employed to move bulky items from the interim storage area to the kerbside (or designated collection point).

## Garbage and recyclables collection point

If low-rise developments are spread across a large area and incorporate more than one communal storage area, it may be appropriate to have more than one waste collection point for servicing the development (subject to street frontage and access).

For MGB-based waste collection systems, the waste collection point is typically from the kerb.

The collection point for bulk bins should meet the general requirements specified in Chapter 2.

## Example diagrams

The following diagrams provide examples of the location of bin storage areas for possible low-rise developments. They are a guide only; other arrangements could be suitable and in accordance with best practice principles. Remember to consult with council engineers, planners and waste managers regarding development requirements specific to a local area.

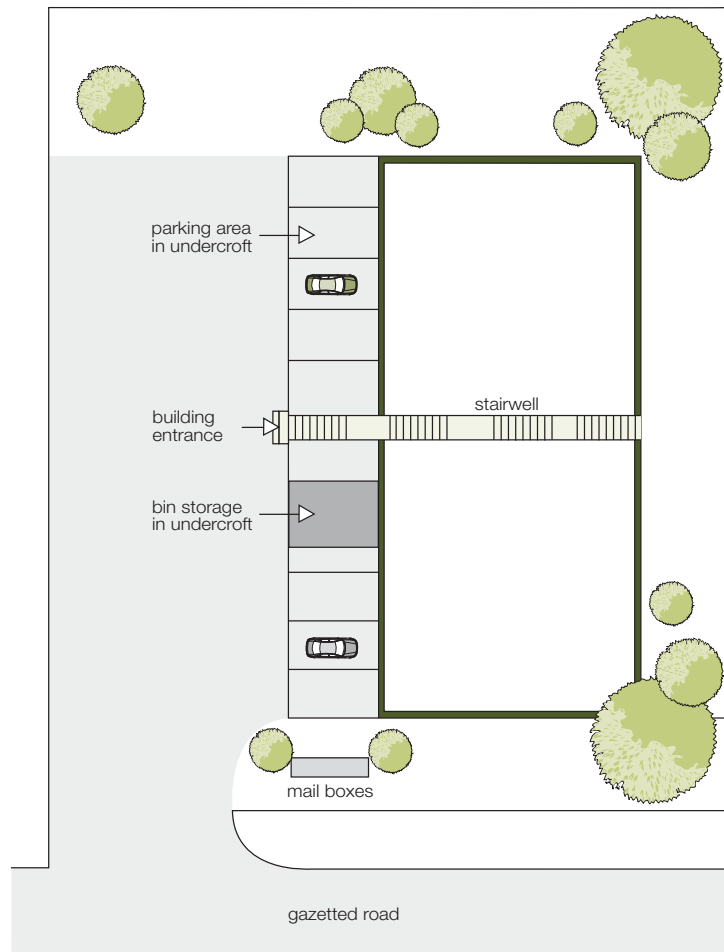

**Figure 4.1 Example of Option 1: MGBs used for garbage and recyclables**

*This example has a communal storage area at ground level, adjacent to resident parking. The storage area is easily accessible to residents using the main building entrance. In this example, a caretaker may transfer bins to and from the kerbside for collection or an arrangement may be in place for on-site collection.*



# Low-Rise Developments

Guide to Best Practice for Waste Management in Multi-unit Developments



**Figure 4.2 Example of Option 2: bulk bins used for garbage and MGBs for recyclables**

*In this example, multiple communal storage areas are used to service the overall development, with one communal storage area for each block of units. Dual street frontage enables bulk bins and MGBs to be used for collection, with bins spread between at least two collection points. It is possible to have on-site servicing of bins, as the collection vehicle could enter and leave the development in a forward direction, using the dual access points.*

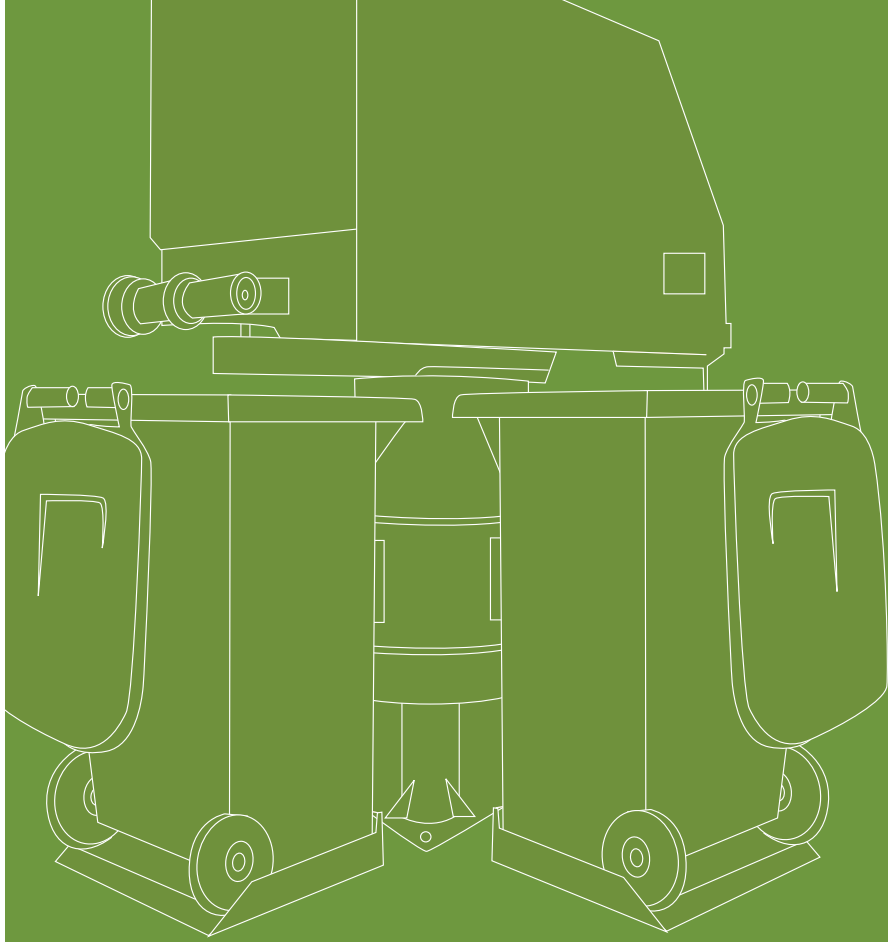

5

Residential Blocks 4-7 Storeys

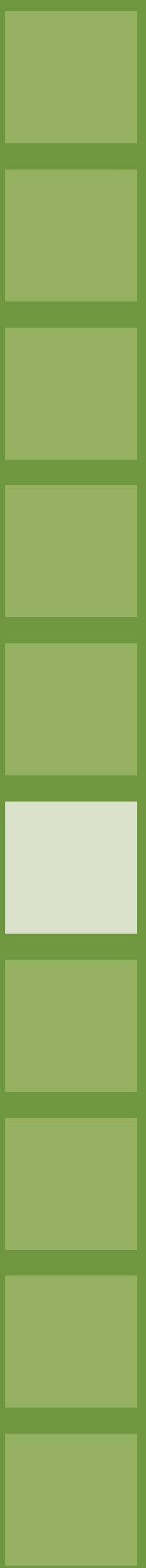



Residential blocks of four to seven storeys are medium to large blocks of units, with separate dwellings on each storey. Blocks of units with four or more storeys must have lift access to the upper levels.

Elements of this development type are also relevant to the residential component of hotels and serviced units.

## Issues for consideration

The issues discussed in this chapter need to be considered in addition to those applying to all developments as outlined in Chapter 2.

## Best practice garbage and recycling systems and services

Examples of best practice waste management in developments with four to seven storeys include:

- **Option 1:** Use mobile garbage bins (MGBs) or bulk bins for garbage and recyclables, with bins stored in a communal storage area (see note 1). Residents carry all waste and recyclables from their unit directly to the communal storage area.
- **Option 2:** Provide room for interim storage of garbage (in MGBs) and recyclables (in MGBs or crates) on each floor in an interim storage area. A caretaker takes garbage and recyclables from the interim storage area to a communal storage area, where they are stored in either bulk bins or MGBs (see note 1).
- **Option 3:** Install a chute system for garbage, leading to a central garbage room at the bottom of the building. The chute can empty into either a bulk bin or an MGB carousel. However, the chute may need to empty into a compactor (refer to Appendix B for more information on chutes)

Provide room for interim storage of recyclables in an interim storage area (that also houses the garbage chute inlet hopper) on each floor. A caretaker takes recyclables from the interim storage area to a communal storage area, where recyclables may be stored in either MGBs or bulk bins (see note 1).

Alternatives to Option 3 are to have access to a garbage chute on each floor with a central storage area for recyclables and garbage, for example in the carpark, or to have recycling bins on carpark floors. Both options have implications for building managers with regard to servicing.

The key features of the above systems and their advantages and disadvantages are outlined in Table 5.1.

Note that these systems are provided as examples only and are not intended to constrain good, workable alternatives.

**Note 1:** Some councils provide bulk bins for recyclables, such as paper and cardboard; other councils use 240L MGBs for either source-separated or commingled recyclables. In each case, council's waste management unit will advise what the allocation of garbage and recycling bins will be according to available MGB or bulk skip sizes.

# Residential Blocks 4-7 Storeys

**Table 5.1 Residential blocks four to seven storeys – best practice examples**

## Option 1

- 240L MGBs or bulk bins for garbage and recyclables, with bins stored in a communal storage area(s)
- Residents carry all waste and recyclables from their unit directly to the communal storage area

Note: this option is only viable in blocks with a smaller number of units.

Advantages	Disadvantages	System requirements
<p>Simple and easy-to-use for both garbage disposal and recycling.</p> <p>Encourages participation in recycling through co-location of garbage and recycling bins.</p> <p>Will still work fairly well without a full-time caretaker, as long as responsibility for moving bins to and from the collection point is clearly defined.</p>	<p>Less convenient for residents compared with other systems, as they need to carry all garbage and recyclables down to the storage area.</p> <p>This system may lead to increased contamination of recyclables, as residents often use plastic bags to carry their recycling to the waste area, and place both plastic bags and recycling in the recycling bin.</p> <p>Recycling bins could be contaminated if there is inadequate disposal capacity for garbage.</p> <p>Amenity could be reduced if residents carry garbage and recycling down main lifts and stairwells if there is no service lift.</p> <p>If using MGBs</p> <ul style="list-style-type: none"> <li>■ A large number of MGBs may be needed to service the development. This would require a large storage area (or several smaller areas), and considerable time for ongoing management, including cleaning bins, and moving bins in and out from the collection point.</li> <li>■ Large numbers of bins placed out for collection on the kerbside can reduce amenity and pose risks to pedestrians and motorists from blocking pathways. It also poses a safety risk to collection operators if they have to manually move bins around cars to the waiting collection vehicle.</li> </ul> <p>If using bulk bins</p> <ul style="list-style-type: none"> <li>■ Decreased ownership may result from sharing bins between greater numbers of units.</li> <li>■ Access for safe and efficient emptying of bulk bins may be limited.</li> <li>■ Bulk bins can be heavy when full and pose a serious health and safety risk if they must be manually moved.</li> <li>■ On-site collection is generally required, which may not be available in some local areas.</li> <li>■ Potentially, there could be higher contamination of recycling if using bulk bins compared with MGBs for recyclables collection.</li> <li>■ Bulk bins are generally suitable for paper and cardboard collection, but not commingled recyclables or source-separated glass due to glass breakage and safety issues during collection.</li> </ul>	<p><b>Storage space and location</b></p> <ul style="list-style-type: none"> <li>■ Communal storage areas that are convenient for residents and servicing arrangements</li> <li>■ Adequate garbage capacity to reduce contamination of recycling bins</li> </ul> <p><b>Access for residents and caretakers</b></p> <ul style="list-style-type: none"> <li>■ Storage areas that provide easy access for residents and caretakers to all bins without the need to move bins</li> </ul> <p><b>Access for collection</b></p> <ul style="list-style-type: none"> <li>■ If using MGBs, suitable waste collection point(s) to collect the required number of MGBs that is free from potential obstacles, including parked cars (note, on recycling collection days there may be twice as many bins placed out for collection)</li> <li>■ If using bulk bins, a design that enables efficient on-site collection, with suitable waste collection point(s) to eliminate or minimise manual handling as appropriate (refer to general requirements in Chapter 2)</li> </ul> <p><b>Ongoing management</b></p> <ul style="list-style-type: none"> <li>■ Identified responsibilities for cleaning communal areas and bins, educating residents in the appropriate use of systems, and for moving bins in and out of the storage area for collection</li> <li>■ Clear signs indicating appropriate use of recycling systems</li> </ul>



## Option 2

- Interim storage of garbage and recyclables on each floor in an interim storage area
- Caretaker takes garbage and recyclables from the interim storage area to a communal storage area
- Waste emptied into MGBs or bulk bins for garbage and recyclables in the communal storage area

Advantages	Disadvantages	System requirements
<p>Simple and easy-to-use for both garbage disposal and recycling.</p> <p>Encourages participation in recycling through co-location of garbage and recycling facilities.</p> <p>Storage of smaller quantities of recyclables in each of the interim storage areas provides an opportunity for caretakers to more closely monitor contamination and identify repeat offenders or the need for further education.</p>	<p>Requires regular transfer of garbage and recyclables from the interim storage area to the communal storage area.</p> <p>Residents may clutter the interim storage area with bulky unwanted items that then need to be removed by a caretaker or cleaning staff.</p> <p>Requires a degree of ongoing management in transferring bins to and from the collection point on collection day, and keeping the interim storage areas and communal storage area clean.</p> <p>Recycling bins could be contaminated if there is inadequate disposal capacity provided for garbage in each interim storage area.</p> <p>Amenity could be reduced if residents carry garbage and recyclables down main lifts and stairwells if there is no service lift.</p> <p>If using MGBs in the communal storage area</p> <ul style="list-style-type: none"> <li>■ A large number of MGBs may be required to service the development. This would require a large storage area (or several smaller areas). It would also require considerable time for ongoing management, including cleaning bins, and moving bins.</li> <li>■ Large numbers of bins placed out for collection on the kerbside can reduce amenity and pose risks to pedestrians and motorists by blocking pathways. They also pose a safety risk to operators if they have to manually move bins around cars to the waiting collection vehicle.</li> </ul>	<p><b>Storage space and location</b></p> <ul style="list-style-type: none"> <li>■ An interim storage area on each floor that holds one or more MGBs for garbage and MGBs or crates for recyclables.</li> <li>■ Space in the interim storage area for at least two days' worth of garbage and recyclables from dwellings on each floor.</li> <li>■ Adequate garbage capacity to reduce contamination of recycling bins.</li> </ul> <p><b>Access for residents and caretakers</b></p> <ul style="list-style-type: none"> <li>■ Access for residents limited to the interim storage area on each floor and the bulky items storage area to help prevent theft and vandalism of bins in communal storage areas, and residents placing full bags of rubbish and other large items in the recycling bins.</li> </ul> <p><b>Access for collection</b></p> <ul style="list-style-type: none"> <li>■ If using MGBs, a suitable waste collection point(s) to collect the required number of MGBS that is free from potential obstacles, including parked cars (note, on recycling collection days there may be twice as many bins placed out for collection).</li> <li>■ If using bulk bins, a design that enables efficient on-site collection, with suitable waste collection point(s) to eliminate or minimise manual handling as appropriate (refer to general requirements in Chapter 2).</li> </ul>

continues over page

# Residential Blocks 4-7 Storeys

Guide to Best Practice for Waste Management in Multi-unit Developments

## Option 2 continued

Advantages	Disadvantages	System requirements
	<p>If using bulk bins in the communal storage area</p> <ul style="list-style-type: none"> <li>■ Decreased ownership may result from sharing bins between greater numbers of units.</li> <li>■ Access for safe and efficient emptying of bulk bins may be limited.</li> <li>■ Bulk bins can be heavy when full and pose a serious health and safety risk if they need to be manually moved.</li> <li>■ On-site collection is generally required, which may not be available in some local areas.</li> <li>■ Potentially, there could be higher contamination of recycling if using bulk bins compared with MGBs for recyclables collection.</li> <li>■ Bulk bins are generally suitable for paper and cardboard collection, but not commingled recyclables or source-separated glass due to glass breakage and safety issues during collection.</li> </ul>	<p><b>Occupational health and safety</b></p> <ul style="list-style-type: none"> <li>■ A suitable system to transfer garbage and recyclables from the interim storage areas which minimises OH&amp;S risks and does not reduce amenity.</li> <li>■ A trolley, with space in the storage room to manoeuvre it, if crates are used for storing recyclables.</li> <li>■ If the transfer of garbage from MGBs into bulk bins is required, a system that minimises or eliminates any OH&amp;S risks.</li> </ul> <p><b>Ongoing management</b></p> <ul style="list-style-type: none"> <li>■ A caretaker to regularly (daily is recommended) remove garbage and recyclables from the interim storage areas and transfer them to the communal storage area(s); vital to the system's success.</li> <li>■ Identified responsibilities for cleaning communal areas and bins, educating residents in the appropriate use of systems, and for moving bins in and out of the storage area for collection.</li> <li>■ Clear signs indicating appropriate use of recycling systems.</li> </ul>

# Residential Blocks 4-7 Storeys



## Option 3

- Chute system for garbage leads to a central garbage room at the bottom of the building; the chute empties into a bulk bin, an MGB carousel or a compactor
- Interim storage of recyclables on each floor in an interim storage area (that also houses the garbage chute hopper)
- Caretaker takes recyclables from the interim storage area to a communal storage area
- Recyclables emptied into MGBs or bulk bins for recycling in the communal storage area

Note: the system for garbage needs to be the closest, easiest to use to avoid contamination of recycling bins, and chutes and bins need clear differentiation through the use of different colours and shape of opening.

Advantages	Disadvantages	System requirements
<p>Simple and easy-to-use for both garbage disposal and recycling.</p> <p>Encourages participation in recycling through co-location of garbage and recycling facilities.</p> <p>Storage of smaller quantities of recyclables in each of the interim storage areas provides an opportunity for caretakers to more closely monitor contamination and identify repeat offenders or the need for further education.</p>	<p>Requires regular transfer of recyclables and bulky waste items (unsuitable for disposal in the chute) from the interim storage area to the communal storage area.</p> <p>Residents may clutter the interim storage area with bulky unwanted items that then need to be removed by a caretaker or cleaning staff.</p> <p>Chutes are not suitable to transfer recyclables or bulky items, therefore, two means of transferring materials are required (the chute and manual methods).</p> <p>Recycling bins may be contaminated if they are used for bulky items or other items that cannot fit down chutes.</p> <p>Amenity may be reduced if residents carry recyclables down main lifts and stairwells if there is no service lift.</p> <p>Requires a high degree of ongoing management to maintain the system: to ensure recycling bins are not contaminated, to transfer bins to and from the collection point on collection day, and to keep the interim storage areas and central garbage room clean.</p>	<p><b>Storage space and location</b></p> <ul style="list-style-type: none"> <li>■ An interim storage area on each floor to house the chute inlet hopper for the garbage chute and MGBs or crates for recyclables. Consult the chute manufacturer about space requirements for the chute opening.</li> <li>■ Space in the interim storage area for at least two days' worth of recyclables from all dwellings on the floor. It should: <ul style="list-style-type: none"> <li>• be large enough to accommodate sufficient MGBs/crates to store the recyclables generated over the entire period between collection days, or</li> <li>• have systems in place to empty the containers and transfer the materials to another area on-site in between collections.</li> </ul> </li> <li>■ Daily transfer, if possible, to a central garbage area to avoid hygiene and dumping issues.</li> <li>■ The garbage chute outlet in the central garbage room – the caretaker should not be required to transfer garbage from one side of the building to the other to get it from the chute outlet to the garbage room.</li> <li>■ Additional garbage MGBs next to the recycling MGBs to avoid contamination of recyclables if there is restricted resident access to the garbage room.</li> </ul> <p><b>Access for residents and caretakers</b></p> <ul style="list-style-type: none"> <li>■ Access for residents limited to the interim storage area on each floor and the bulky items storage area to prevent theft and vandalism of bins in communal storage areas, and prevent residents from placing full bags of rubbish and other large items in the recycling bins.</li> <li>■ Restricted resident access into garbage rooms where chutes empty, for safety reasons.</li> </ul>

continues over page

# Residential Blocks 4-7 Storeys

Guide to Best Practice for Waste Management in Multi-unit Developments

## Option 3 continued

Advantages	Disadvantages	System requirements
<p>Chutes enable transfer of garbage from the different floors without the need to manually carry bags and bins up and down stairs and via lifts to the waste storage area. This increases convenience to residents and can result in improved amenity.</p>	<p>Regular maintenance, including cleaning and unblocking chutes, is likely to be required. Regular inspection of the waste room into which the chute empties is also required to ensure bins do not become overfull.</p> <p>If chutes discharge into a compaction unit, the compacted waste bins can become very heavy and increase OH&amp;S risks. Compacted waste may also get jammed in the base of the bins, making it difficult to empty the contents.</p> <p>If using bulk bins in the communal storage area</p> <ul style="list-style-type: none"> <li>■ Access for safe and efficient emptying of bulk bins may be limited.</li> <li>■ Bulk bins can be heavy when full and pose a serious health and safety risk if needing to be manually moved.</li> <li>■ On-site collection is generally required, which may not be available in some local areas.</li> <li>■ Potentially, there could be higher contamination of recycling if using bulk bins compared with MGBs for recyclables collection.</li> <li>■ Bulk bins are generally suitable for paper and cardboard collection, but not commingled recyclables or source-separated glass due to glass breakage and safety issues during collection.</li> </ul>	<p><b>Access for collection</b></p> <ul style="list-style-type: none"> <li>■ If using MGBs, suitable waste collection point(s) to collect the number of MGBs required that is free from potential obstacles, including parked cars (note, on recycling days there may be twice as many bins placed out for collection).</li> <li>■ If using bulk bins, a design that enables efficient on-site collection, with suitable waste collection point(s) for collection of bulk bins to eliminate or minimise manual handling as appropriate (refer to general requirements in Chapter 2).</li> </ul> <p><b>Occupational health and safety</b></p> <ul style="list-style-type: none"> <li>■ A suitable system to transfer recyclables from the interim storage areas to the communal storage area that minimises OH&amp;S risks and does not reduce amenity.</li> <li>■ If crates are used for storing recyclables, a trolley, with space in the storage room to manoeuvre it.</li> </ul> <p><b>Ongoing management</b></p> <ul style="list-style-type: none"> <li>■ A caretaker to regularly remove recyclables from the interim storage areas and transfer them to the communal storage area(s) is vital to the system's success.</li> <li>■ Clear signs indicating appropriate use of recycling systems.</li> <li>■ Ongoing education for residents in the correct use of the chute, and the need to keep bulky items and recyclables out of the chute system.</li> <li>■ No overloading of bins resulting from compacted waste.</li> <li>■ Regular maintenance, including cleaning and possibly unblocking chutes.</li> <li>■ Regular inspection of the room into which the waste chute empties to ensure bins do not become overfull.</li> </ul>





## Storage – space and location

### Communal bin areas

It is essential to provide sufficient space to store all garbage and recyclables likely to be generated in the period between collection days, and the equipment used to manage and store them. There may be more than one communal storage point.

### Bulky items storage

Consider allowing space, adjacent to the waste storage area, for residents to temporarily store unwanted bulky items, while awaiting disposal. This is important to stop residents illegally dumping this material on the footpath, which detracts significantly from the quality and appearance of the development.

The space allocated to store bulky items should consider the intended frequency of collection. Bulky items may be collected by council or contractors. Alternatively, tenants or building managers may make arrangements to take excess bulky items to a waste management centre.

If council provides a bulky items collection, it is important to check the details of the service, as the frequency and the types and sizes of materials collected may differ between local government areas. If on-site collection is not available, a caretaker should be employed to move bulky items from the interim storage area to the kerbside (or designated collection point).

## Supporting infrastructure

### Trolleys to accommodate recycling crates

Identify a suitable system to transfer recyclables from the interim storage areas that minimises OH&S risks and does not reduce amenity.

If crates are used for storing recyclables, a trolley may be necessary, and the storage room will need to accommodate manoeuvring the trolley.

### Bin lifters

If MGBs containing garbage or recyclables have to be emptied into bulk bins, provide equipment to eliminate the need to manually lift and empty the bin. In this situation, the waste storage area design needs to incorporate sufficient space to locate and operate the lifting device. The lifting device should be fitted with safety features to prevent injury to operators, and should be secured to prevent use by residents.

The cost of buying and maintaining the bin lifter and the employment of a caretaker to operate it should be factored into the ongoing management of the development. In addition, most councils will only provide one set of bins to a development (i.e. MGBs or bulk bins, but not both), so the cost of an additional set of bins should also be factored in.

Refer to Appendix B for further information about bin lifters and their potential application in MUDs.

### Service lifts

If a development incorporates interim storage areas on each level, a service lift should be provided to enable the transfer of materials from the compartment to the communal storage area.

# Residential Blocks 4-7 Storeys

Guide to Best Practice for Waste Management in Multi-unit Developments

## Access

If vandalism or waste dumping is likely to be a serious problem, consider having a secure, central area which is lockable to store bulky items.

## Ongoing management

All waste management systems in four- to seven-storey residential buildings require some degree of ongoing management. A caretaker or manager can maintain clean waste storage areas and keep them free of dumped rubbish, ensure new residents are aware of the waste management arrangements and liaise with the council or collection contractor.

If systems use interim storage areas on each floor, a caretaker is definitely required to manage the transfer of waste and/or recycling from interim storage areas on each floor to communal storage areas and/or to the collection point.

The costs of a caretaker or manager should be factored into the ongoing management of the development.

Conditions of consent can require that a development comply with the submitted and approved waste management plan for the development. If a caretaker is required, this should be detailed in the waste management plan; employment of a caretaker will then form part of the conditions of consent, which must be adhered to.

## Example diagrams

The following figures provide examples of the location of bin storage areas for possible four- to seven-storey developments. These examples are a guide only, many other arrangements could be suitable and in accordance with best practice principles. Remember to consult with council engineers, planners and waste managers regarding development requirements specific to a local area.

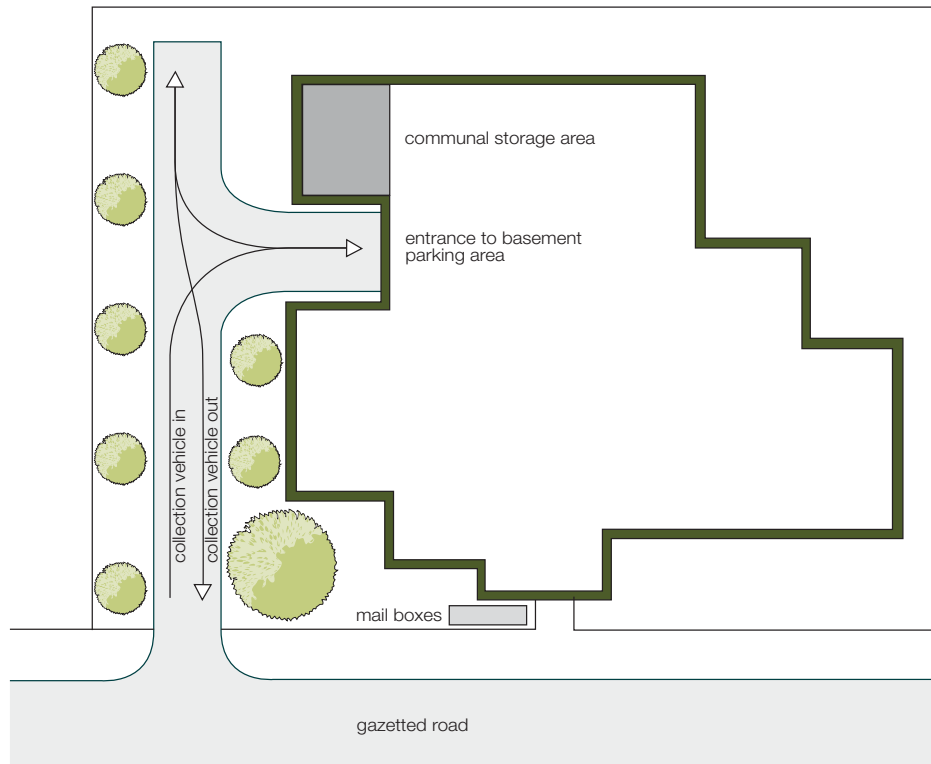

**Figure 5.1 Example of Option 1 or Option 2**

*This example demonstrates locating a communal storage area for a four- to seven-storey MUD at the rear of the development, but adjacent to the carpark entrance so it is conveniently accessible and visible to carpark users. On-site collection of bins is possible since there is sufficient turning space in the driveway design for a waste collection vehicle to make a three-point turn. The collection vehicle enters the property in a forward direction, noses into the start of the carpark entrance driveway, reverses to the area adjacent to the bin storage area where collection would take place, and leaves the property in a forward direction.*

*Alternatively, depending on the number and size of bins used in this development and the distance between the storage area and kerbside, it may be possible to arrange for kerbside collection of bins. In this case, a caretaker would manage the movement of bins to and from the collection point and storage area.*

# Residential Blocks 4-7 Storeys

Guide to Best Practice for Waste Management in Multi-unit Developments

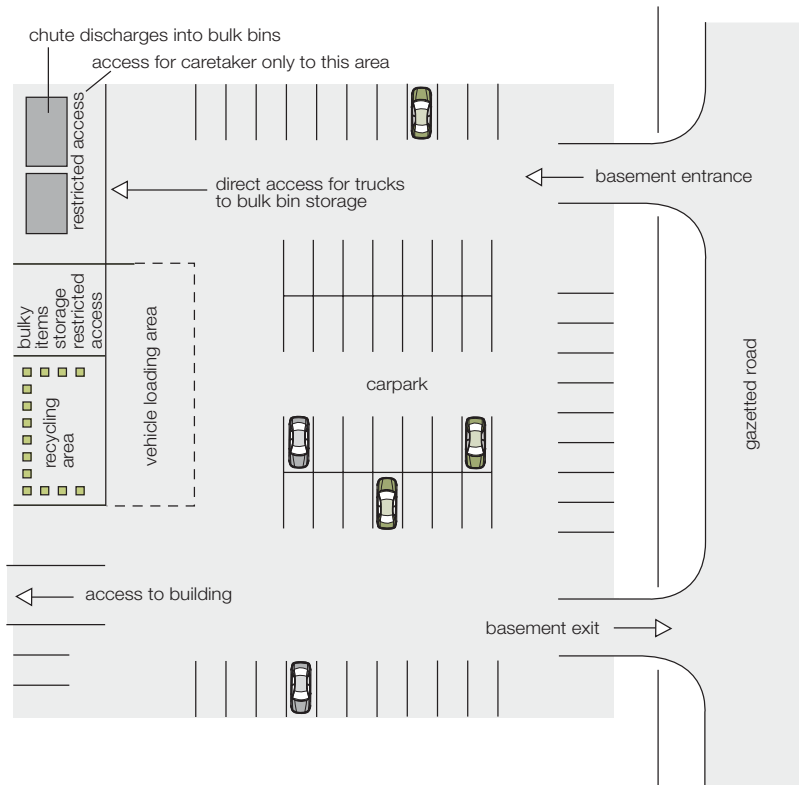

**Figure 5.2 Example of Option 3: use chute for garbage and MGBs for recyclables**

*This example demonstrates on-site collection of bulk garbage bins and MGB recycling bins from the basement of a four- to seven-storey building. There is no access to the bulk bin storage area for residents; however, they can access the recycling and bulky waste storage areas.*

*Direct access is provided for the garbage collection vehicle to drive forward up to the bulk bin storage area and use an overhead lift and empty the garbage. The garbage collection vehicle then proceeds to drive through the carpark and leaves the basement, always moving in a forward direction.*

*The recycling collection vehicle enters the basement and proceeds to directly in front of the recycling storage area. Sufficient space is provided to make the collection without obstructing traffic flow through the carpark. This example assumes recycling bins are wheeled from the storage area to a rear-loading collection vehicle. The vehicle then leaves the basement carpark in a forward direction. Similarly, bulky waste is moved from the bulky waste storage area to the waiting bulky waste collection vehicle at the time of collection.*

**Note:** *in the above example, additional MGBs for garbage are available to residents in the recycling area to prevent contamination of recyclables.*

# Residential Blocks 4-7 Storeys

Guide to Best Practice for Waste Management in Multi-unit Developments

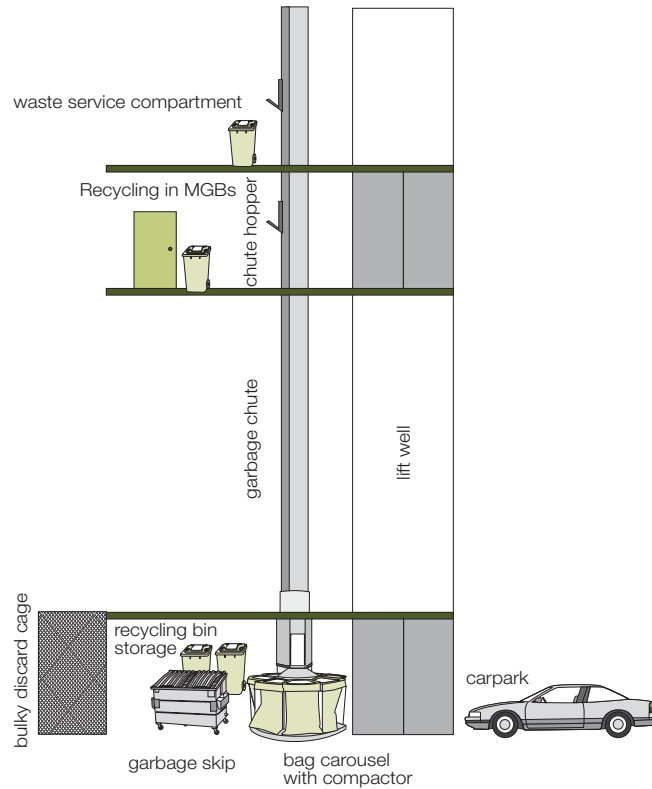

**Figure 5.3 Cross-section of Option 3: interim storage area and chute system**

*This example demonstrates the general principles and operation of a garbage chute system supported by recycling bins located within the interim storage area on each level. Additional recyclables storage and storage for bulky waste items is provided in the carpark of the building. The chute discharges into an MGB carousel (or possibly bulk skips), which is located in a room normally locked and not accessible to residents.*

**Note:** *in the above example, additional MGBs for garbage are available to residents in the recycling area to prevent contamination of recyclables.*

# Residential Blocks 4-7 Storeys

Guide to Best Practice for Waste Management in Multi-unit Developments

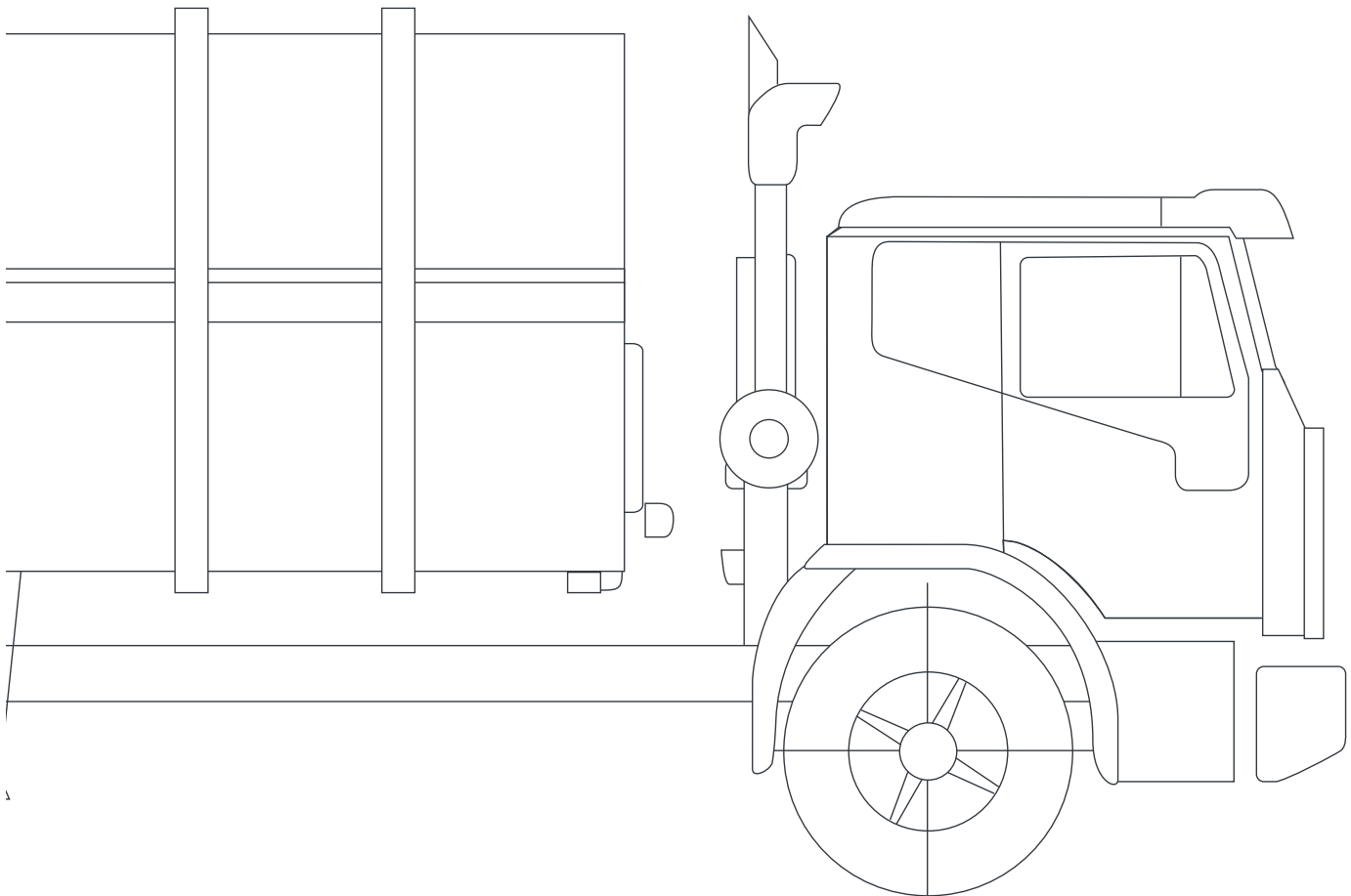

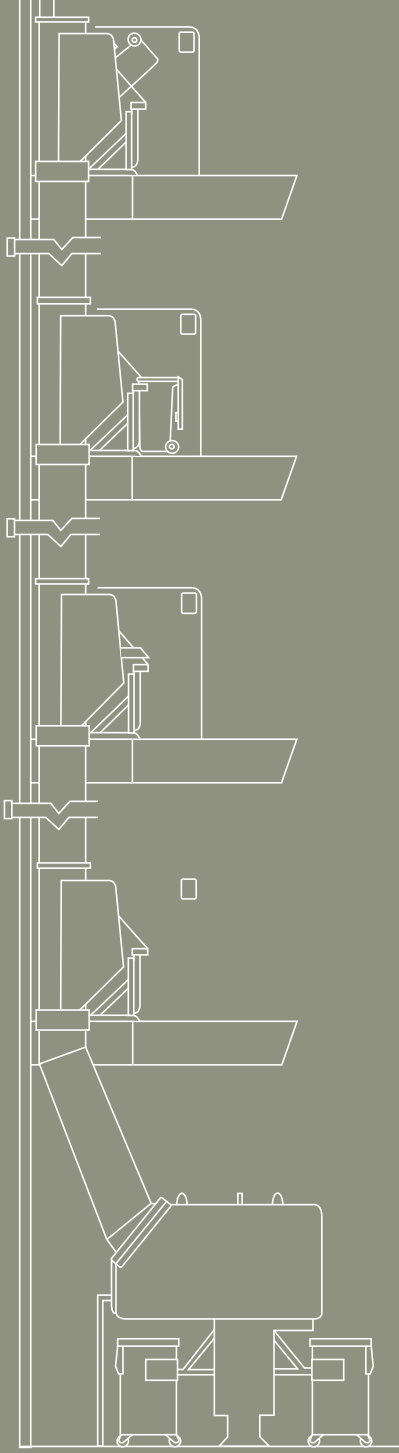

6

Residential Blocks  
7 or More Storeys





High-rise developments are large blocks of units that are more than seven storeys high, with separate dwellings on each storey. Blocks of units with four or more storeys must have lift access to the upper levels.

Elements of this development type are also relevant to the residential component of hotels and serviced units.

## Issues for consideration

The issues discussed in this chapter need to be considered in addition to those applying to all developments as outlined in Chapter 2.

## Best practice garbage and recycling systems and services

Designing a waste management system for high-rise buildings needs to be done with care. Due to the large amount of material generated, poor design decisions can have serious repercussions for the management of the building.

Examples of best practice waste management in high-rise developments.

- **Option 1:** Provide room for interim storage of garbage (in mobile garbage bins [MGBs]) and recyclables (in MGBs or crates) on each floor in an interim storage area. A caretaker takes garbage and recyclables from the interim storage area to a communal storage area, where they are stored in either bulk bins or MGBs (see note 1).
- **Option 2:** Install a chute system for garbage that leads to a central garbage room at the bottom of the building. The chute empties into a bulk bin, an MGB carousel or a compactor (refer to Appendix B for further information on chutes).

Storage of recyclables is in an interim storage area (which also houses the garbage chute inlet hopper) on each floor. A caretaker takes recyclables from the interim storage area to a communal storage area (see note 1).

Alternatives to Option 2 are to have access to a garbage chute on each floor with a central storage area for recyclables and garbage, for example in the carpark, or to have recycling bins on carpark floors. Both options have implications for building managers with regard to servicing.

The main features of the above systems and their advantages and disadvantages are outlined in Table 6.1.

Note that these systems are provided as examples only and are not intended to constrain good, workable alternatives.

**Note 1:** some councils provide bulk bins for recyclables, such as paper and cardboard; other councils use 240L MGBs for either source-separated or commingled recyclables. In each case, council's waste management unit will advise what the allocation of bins will be, according to available MGB or bulk bin sizes.



# Residential Blocks 7 or More Storeys

Guide to Best Practice for Waste Management in Multi-unit Developments

**Table 6.1 High-rise development – best practice examples**

## Option 1

- Interim storage of garbage and recyclables on each floor in an interim storage area
- Caretaker takes garbage and recyclables from the interim storage area to a communal storage area
- Waste is emptied into MGBs or bulk bins for garbage and recyclables in the communal storage area

Advantages	Disadvantages	System requirements
<p>Simple and easy-to-use for both garbage disposal and recyclables.</p> <p>Encourages participation in recycling through co-location of garbage and recycling facilities.</p> <p>Interim storage of smaller quantities of recyclables in each of the interim storage areas provides an opportunity for caretakers to more closely monitor system performance, contamination and identify repeat offenders or the need for further education.</p>	<p>Requires regular transfer of garbage and recyclables from the interim storage area to the communal storage area.</p> <p>Residents may clutter the interim storage area with bulky unwanted items that then need to be removed by a caretaker or cleaning staff.</p> <p>Requires a degree of ongoing management in transferring bins to and from the collection point on collection day, and keeping the interim storage areas and central garbage room clean.</p> <p>Recycling bins could be contaminated if there is inadequate disposal capacity for garbage in each interim storage area.</p> <p>Amenity could be reduced if residents carry recyclables down main lifts and stairwells if there is no service lift.</p>	<p><b>Storage space and location</b></p> <ul style="list-style-type: none"> <li>■ An interim storage area on each floor that holds one or more MGBs for garbage and MGBs or crates for recyclables.</li> <li>■ Space in the interim storage area for the interim storage of at least two days' worth of garbage and recyclables from dwellings on each floor.</li> <li>■ Adequate garbage capacity to reduce contamination of recycling bins.</li> </ul> <p><b>Access for residents and caretakers</b></p> <ul style="list-style-type: none"> <li>■ Access for residents limited to the interim storage area on each floor and the bulky items storage area to help prevent theft and vandalism of bins in communal storage areas, and residents placing full bags of rubbish and other large items in the recycling bins.</li> </ul> <p><b>Access for collection</b></p> <ul style="list-style-type: none"> <li>■ If using MGBs, suitable waste collection point(s) to collect the required number of MGBs that is free from potential obstacles, including parked cars (remember on recycling collection days there may be twice as many bins placed out for collection).</li> <li>■ If using bulk bins, a design that enables efficient on-site collection, with suitable waste collection point(s) to eliminate or minimise manual handling as appropriate (refer to general requirements in Chapter 2).</li> </ul>

continues over page

# Residential Blocks 7 or More Storeys

Guide to Best Practice for Waste Management in Multi-unit Developments



## Option 1 continued

Advantages	Disadvantages	System requirements
	<p>If using MGBs in the communal storage area:</p> <ul style="list-style-type: none"> <li>■ A large number of MGBs from high-rise developments are likely to be acceptable to most councils and may be required to service the development. This would require a large storage area (or several smaller areas). It would also require considerable time for ongoing management, including cleaning bins, and moving bins to and from the collection point.</li> <li>■ Large numbers of bins placed out for collection on the kerbside can reduce amenity and pose risks to pedestrians from blocked pathways. It also poses a safety risk to collection operators if they have to manually move bins around cars to the waiting collection vehicle.</li> </ul> <p>If using bulk bins in the communal storage area</p> <ul style="list-style-type: none"> <li>■ Decreased ownership may result from sharing bins between greater numbers of units.</li> <li>■ Access for safe and efficient emptying of bulk bins may be limited.</li> <li>■ Bulk bins can be heavy when full and pose a serious health and safety risk if they need to be manually moved.</li> <li>■ On-site collection is generally required, which may not be available in some local areas.</li> <li>■ Potentially, there could be higher contamination of recycling if using bulk bins compared with MGBs for recyclables collection.</li> <li>■ Bulk bins are generally suitable for paper and cardboard collection, but not commingled recyclables or source-separated glass due to glass breakage and safety issues during collection.</li> </ul>	<p><b>Occupational health and safety</b></p> <ul style="list-style-type: none"> <li>■ A suitable system to transfer garbage and recyclables from the interim storage areas that minimises OH&amp;S risks and does not reduce amenity.</li> <li>■ A trolley, with space in the storage room to manoeuvre it, if crates are used for storing recyclables.</li> <li>■ If the transfer of garbage from MGBs into bulk bins is required, a system that minimises or eliminates any OH&amp;S risks.</li> </ul> <p><b>Ongoing management</b></p> <ul style="list-style-type: none"> <li>■ A caretaker to regularly remove garbage and recyclables (daily is recommended) from the interim storage areas and transfer them to the communal storage area(s); vital to the system's success.</li> <li>■ Identified responsibilities for cleaning communal areas and bins, educating residents in the appropriate use of systems, and for moving bins in and out of the storage area for collection.</li> <li>■ Clear signs indicating the appropriate use of the recycling systems.</li> </ul>

# Residential Blocks 7 or More Storeys

Guide to Best Practice for Waste Management in Multi-unit Developments

## Option 2

- Chute system for garbage leads to a central garbage room at the bottom of the building; the chute empties into a bulk bin, an MGB carousel or a compactor
- Interim storage of recyclables on each floor in an interim storage area (that also houses the garbage chute hopper)
- Caretaker takes recyclables from the interim storage area to a communal storage area
- Recyclables are emptied into MGBs or bulk bins for recyclables are used in the communal storage area

Note: the system for garbage needs to be the closest, easiest to use to avoid contamination of recycling bins, and chutes and bins need clear differentiation through the use of different colours and shape of opening.

Advantages	Disadvantages	System requirements
<p>Simple and easy to use system for both garbage disposal and recycling.</p> <p>Encourages participation in recycling through co-location of garbage and recycling facilities.</p> <p>Interim storage of smaller quantities of recyclables in each of the interim storage areas provides an opportunity for caretakers to more closely monitor contamination and identify repeat offenders or the need for further education.</p> <p>Chutes enable the transfer of garbage from the different floors within a development without the need to manually carry bags and bins up and down stairs and via lifts to the waste storage area. This increases convenience to residents and if well managed can result in improved amenity (due to reduced transfer of garbage in trafficable areas).</p>	<p>This system requires the regular transfer of recycling and bulky waste items (unsuitable for disposal in the chute) from the interim storage area to the communal storage area.</p> <p>Residents may clutter the interim storage area with bulky unwanted items that then need to be removed by a caretaker or cleaning staff.</p> <p>Chutes are not suitable to transfer recyclables or bulky items, therefore two means of transferring materials in each development are required (the chute and manual methods).</p> <p>Recycling bins could be contaminated if bulky items or other items that cannot fit down chutes are placed in the recycling stream.</p> <p>Amenity could be reduced if residents carry recycling down main lifts and stairwells if there is no service lift.</p> <p>This system requires a high degree of ongoing management to maintain the system: to ensure recycling bins are not contaminated, to transfer bins to and from the collection point on collection day, and to keep the interim storage areas and central garbage room clean.</p>	<p><b>Storage space and location</b></p> <ul style="list-style-type: none"> <li>■ An interim storage area on each floor to house the chute inlet hopper for the garbage chute and MGBs or crates for recyclables. Consult the chute manufacturer about space requirements for the chute opening.</li> <li>■ Space in the interim storage area for at least two days' worth of recyclables from all dwellings on the floor. It should: <ul style="list-style-type: none"> <li>• be large enough to accommodate sufficient MGBs/crates to store the recyclables generated over the entire period between collection days, or</li> <li>• have systems in place to empty the containers and transfer the materials to another area on-site in between collections.</li> </ul> </li> <li>■ Daily transfer, if possible, to a central garbage area to avoid hygiene and dumping concerns.</li> <li>■ The garbage chute outlet in the central garbage room – the caretaker should not be required to transfer garbage from one side of the building to the other to get it from the chute outlet to the garbage room.</li> <li>■ Additional garbage MGBs next to the recycling MGBs to avoid contamination of recyclables if resident access to the garbage is restricted.</li> </ul>

continues over page

# Residential Blocks 7 or More Storeys

Guide to Best Practice for Waste Management in Multi-unit Developments



## Option 2 continued

Advantages	Disadvantages	System requirements
	<p>Regular maintenance, including cleaning and unblocking chutes is likely to be required. Regular inspection of the waste room into which waste discharges is also required to ensure bins do not become overfull.</p> <p>If chutes discharge into a compaction unit, the compacted waste bins can become very heavy and increase OH&amp;S risks. Compacted waste may also get jammed in the base of the bins, making it difficult to empty the contents.</p> <p>If using bulk bins in the communal storage area</p> <ul style="list-style-type: none"> <li>■ Access for safe and efficient emptying of bulk bins may be limited.</li> <li>■ Bulk bins can be heavy when full and pose a serious health and safety risk if they have to be manually moved.</li> <li>■ On-site collection is generally required, which may not be available in some local areas.</li> <li>■ Potentially, there could be higher contamination of recycling if using bulk bins compared with MGBs for recyclables collection.</li> <li>■ Bulk bins are generally suitable for paper and cardboard collection, but not commingled recyclables or source-separated glass due to glass breakage and safety issues during collection.</li> </ul>	<p><b>Access for residents</b></p> <ul style="list-style-type: none"> <li>■ Restricted resident access into garbage rooms where chutes empty (if applicable), for safety reasons.</li> </ul> <p><b>Ongoing management</b></p> <ul style="list-style-type: none"> <li>■ A caretaker to regularly remove recyclables from the interim storage areas and transfer them to the communal storage area(s); vital to the system's success.</li> <li>■ Clear signs indicating appropriate use of recycling systems.</li> <li>■ Ongoing education for residents in the correct use of the chute, and the need to keep bulky items and recyclables out of the chute system.</li> <li>■ No overloading of bins if waste compactor is used.</li> <li>■ Regular maintenance, including cleaning and unblocking chutes.</li> <li>■ Regular inspection of the waste room into which waste discharges to ensure bins do not become overfull.</li> </ul>

# Residential Blocks 7 or More Storeys

Guide to Best Practice for Waste Management in Multi-unit Developments

## Storage – space and location

### Communal bin areas

It is essential to provide, at appropriate locations in the building, sufficient space to store all garbage and recyclables likely to be generated in the period between collection days, and the equipment used to manage and store it. There may be more than one storage point.

Consider how the bins are to be emptied and how much room will be required to manoeuvre the bins to where they will be emptied.

### Bulky items storage

Given the number of units in high-rise buildings, there can be a constant turnover of residents. Consider allowing space, adjacent to the waste storage area, for residents to temporarily store unwanted bulky items. Providing storage on-site for the disposal of bulky items is important to stop residents illegally dumping this material on the footpath, which detracts significantly from the quality and appearance of the development. While education about available clean-up services can assist, serious dumping problems can occur if a substantial proportion of the building's population is transient.

The space allocated for bulky items storage should take into account the intended frequency of collection. Bulky items may be collected by council or contractors. Alternatively, tenants or building managers may make arrangements to take excess bulky items to a waste management centre.

If council provides a bulky items collection, it is important to check the details of the service, as the frequency and the types and sizes of materials collected may differ between local government areas. If on-site collection is not available, a caretaker should be employed to move bulky items from the interim storage area to the kerbside (or designated collection point).

## Supporting infrastructure

### Trolleys

Identify a suitable system to transfer recyclables from the interim storage areas that minimises OH&S risks and does not reduce amenity.

If crates are used for storing recyclables, a trolley may be necessary, and the storage room will need to accommodate manoeuvring the trolley.

### Bin lifters

If MGBs containing garbage or recyclables need to be emptied into bulk bins, provide equipment to eliminate the need to manually lift and empty the bin.

In this situation, the design of waste storage areas needs to incorporate sufficient space to locate and operate the lifting device. Fit the lifting device with safety features to prevent injury to operators, and secure it to prevent use by residents.

The cost of procuring and maintaining the bin lifter and employing a caretaker to operate it should be considered and factored into the ongoing management of the development. In addition, most councils will only provide one set of bins to a development (i.e. MGBs or bulk bins, but not both), so the cost of an additional set of bins should also be factored in.

Refer to Appendix B for further information about bin lifters and their potential application in MUDs.

### Service lifts

If a development incorporates interim storage areas on each level, it is recommended that a service lift should be provided to enable the transfer of materials from the compartment to the communal storage area.



## Access

### For residents

Access for residents to waste facilities should be limited to the interim storage area on each floor and the bulky items storage area. This prevents theft and vandalism of bins in communal storage areas, and also prevents residents placing large items in the recycling bins.

If vandalism or waste dumping is likely to be serious problem, consider having a secure, centralised lockup area for bulky items.

### For collectors

If using MGBs, identify a suitable waste collection point(s) to collect the required number of MGBs that is free from potential obstacles, including parked cars (remember on recycling days there may be twice as many bins placed out for collection).

If using bulk bins, design the development for their efficient on-site collection. Identify a suitable waste collection point(s) to collect bulk bins to eliminate or minimise manual handling as appropriate (refer to general requirements in Chapter 2).

## Ongoing management

Employment of a caretaker is vital to the success of waste management systems in high-rise developments. Caretakers are needed to manage the regular removal of materials from the interim storage areas and their transfer to the communal storage area(s); transfer receptacles to the collection point; keep waste storage areas clean and free of dumped rubbish; ensure new residents are aware of the waste management arrangements; and liaise with the waste collection contractor.

The cost of employing a caretaker should be factored into the ongoing management of the development.

Conditions of consent can require that a development comply with the submitted and approved waste management plan. If a caretaker is required, this should be detailed in the waste management plan; employment of a caretaker will then form part of the conditions of consent, which must be adhered to.

# Residential Blocks 7 or More Storeys

Guide to Best Practice for Waste Management in Multi-unit Developments

## Example diagrams

The following figures provide examples of the location of bin storage areas for possible high-rise developments. These examples are a guide only, many other arrangements could be suitable and in accordance with best practice principles. Remember to consult with council engineers, planners and waste managers regarding development requirements specific to a local area.

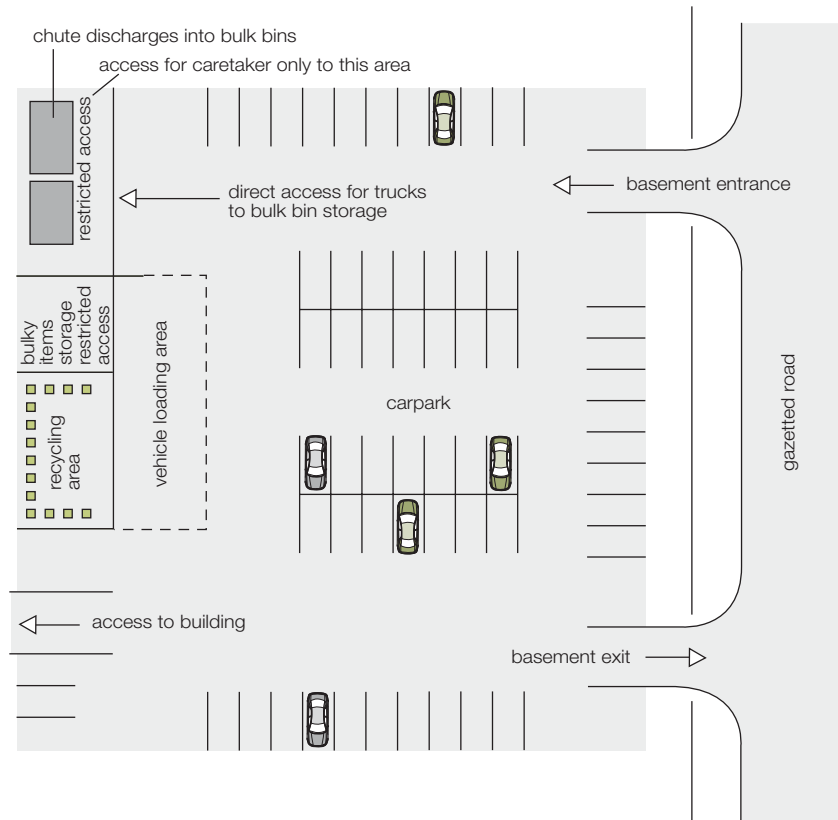

**Figure 6.1 Example of Option 1 or Option 2**

*This example demonstrates on-site collection of either MGBs or bulk garbage bins and MGB recycling bins from the basement of a high-rise building. If a chute system is used (as in Option 2), there is no access to the garbage storage area for residents; however, residents can still access the recycling and bulky waste storage areas.*

*Direct access is provided for the garbage collection vehicle to drive forwards up to the bulk bin storage area and make an overhead lift and empty the garbage. The garbage collection vehicle then proceeds to drive through the carpark and leaves the basement, always moving in a forward direction.*

*The recycling collection vehicle enters the basement and proceeds to directly in front of the recycling storage area. Sufficient space is provided for the collection to be made without obstructing traffic flow through the carpark. This example assumes recycling bins are wheeled from the storage area to a rear-loading collection vehicle. The vehicle then leaves the basement carpark in a forward direction. Similarly, bulky waste is moved from the bulky waste storage area to the waiting bulky waste collection vehicle at the time of collection.*

**Note:** *In this example, additional MGBs for garbage would be available to residents in the recycling area to prevent contamination of recyclables. In addition, there would be sufficient overhead clearance to allow the garbage truck to operate.*

# Residential Blocks 7 or More Storeys

Guide to Best Practice for Waste Management in Multi-unit Developments

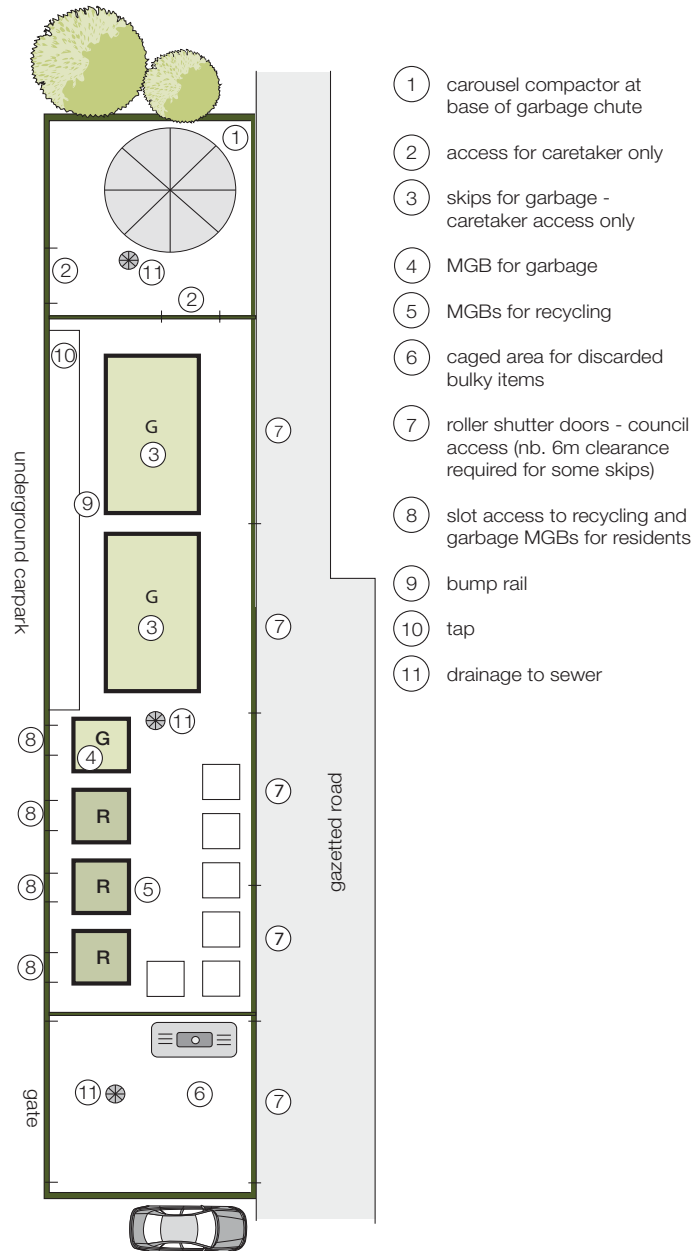

**Figure 6.2 Example of Option 2: secure waste storage area for high-rise development**

*This example demonstrates a possible layout for a secure garbage area for a high-rise development. This type of arrangement may typically be located in a basement or underground carpark.*

*In this example, access for residents to garbage and recycling facilities is limited to the interim storage area and chute inlet hopper on each floor. Access to rooms where the chute empties and extra bins are stored is restricted to the caretaker. This is for safety reasons and to discourage dumping.*

*Secure recycling bins are also included in the lockable garbage room in an effort to prevent vandalism. In this example, the recycling bins are kept in a locked room or cage and access to the recycling bins for residents is by a slot in the wall of the room or cage. This prevents theft and vandalism of the bins, and also prevents residents placing full bags of rubbish and other large items in the recycling bins (as they cannot fit through the slot).*

*Additional storage for bulky waste items and an area to wash down bins are incorporated in the facilities.*



# Residential Blocks 7 or More Storeys

Guide to Best Practice for Waste Management in Multi-unit Developments

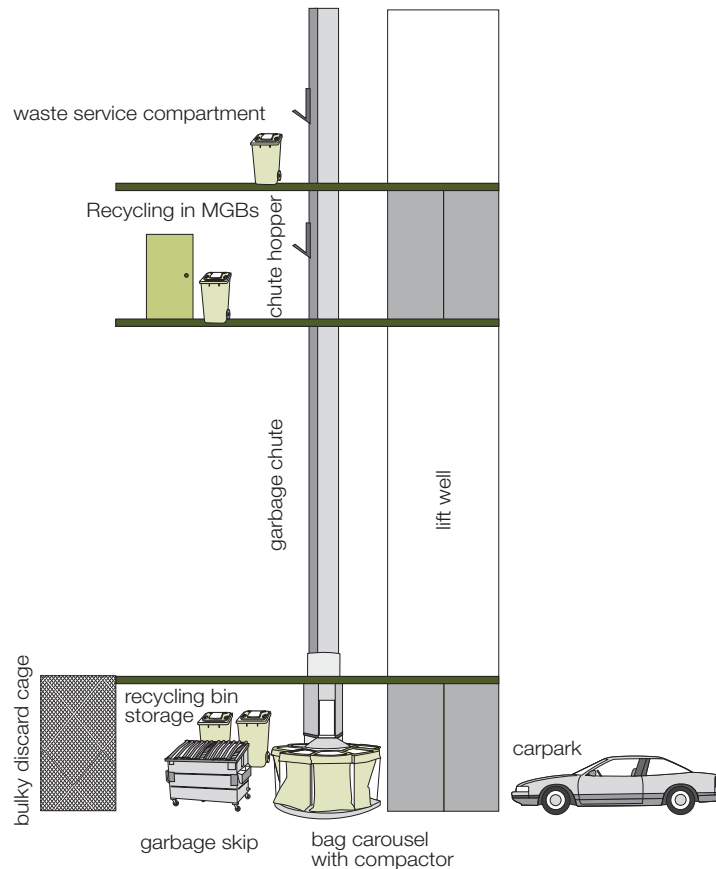

**Figure 6.3 Cross-section of Option 2: example interim storage area and chute system**

*This example demonstrates the general principles and operation of a garbage chute system supported by recycling bins located within the interim storage area on each level. Additional storage for recyclables and bulky waste items is provided in the building's carpark. The chute discharges into an MGB carousel (or possibly bulk skips), which is located in a room normally locked and not accessible to residents.*

**Note:** *In the above example, additional MGBs for garbage would be available to residents in the recycling area to prevent contamination of recyclables.*

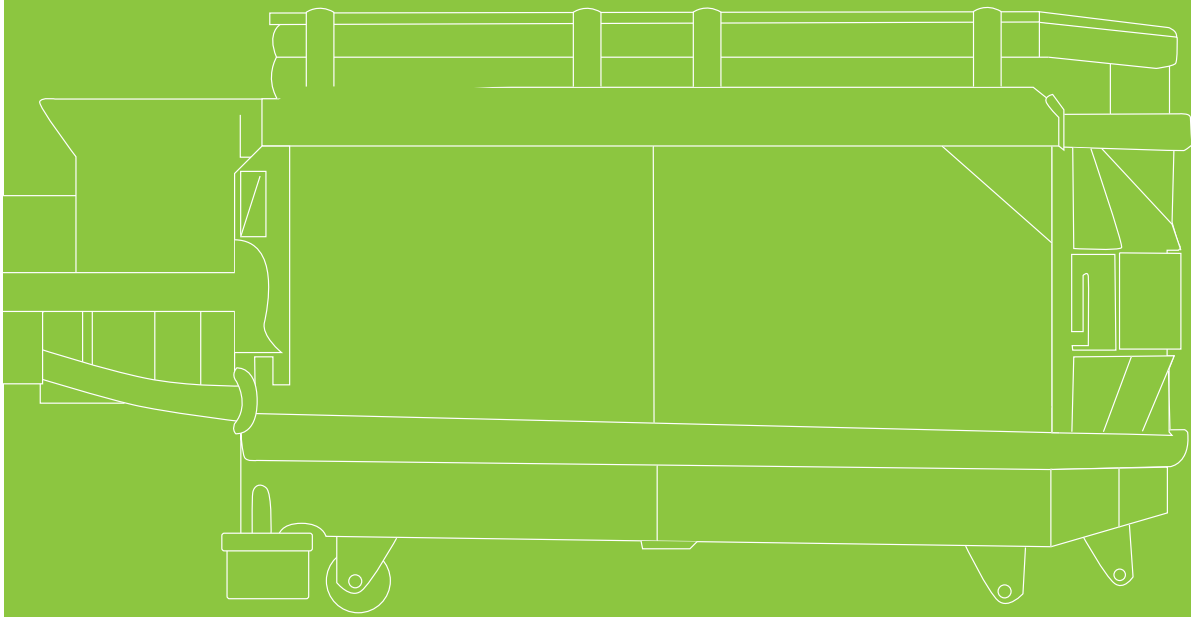

# 7

## Mixed-use Development

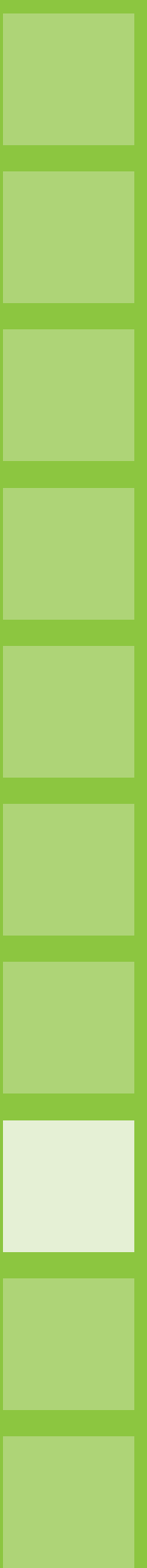



Mixed-use developments incorporate both residential and commercial use within the same development and include, for example, housing above shops.

Mixed-use developments may be small – for example, two storeys incorporating a residential property on the top floor and commercial outlet on ground level – or they may be large, with one or more levels of commercial property beneath low-rise or larger medium- to high-rise residential developments.

## Issues for consideration

The issues discussed in this chapter need to be considered in addition to those applying to all developments as outlined in Chapter 2.

### Unintended usage

There are often serious problems in mixed-use developments with commercial tenants using the residential waste facilities (or vice versa), which can cause overloading of the waste management system, unhygienic conditions and disputes over payment for collection.

Best practice waste management in mixed-use developments requires the complete separation of the residential and commercial waste facilities. Residential and commercial tenants should be actively discouraged from using each other's waste facilities.

### Provision of services

Councils are not required to provide waste services to commercial businesses, so they may elect to service only the residential dwelling component of mixed-use developments. In this situation, a private waste contractor needs to remove the commercial waste, or a private waste contractor may be engaged to remove both the residential and commercial garbage and recycling.

If a private contractor is used to provide the garbage and recycling services, residents may still be required to pay a service availability charge to council as stipulated under section 146 of the *Local Government Act 1993*, and the contractor's fee.

### Waste types and handling methods

Waste materials from residential and commercial properties differ in quantity and composition. In general, commercial properties generate higher yields of waste than residential properties.

In determining waste handling and storage requirements, consider:

- the likely types of commercial activities that may occur in the development, and the types of waste they may generate (refer to Appendix A)
- the number of residential dwellings and the quantity of residential waste generation (refer to Appendix A for typical residential waste generation rates)
- the waste infrastructure needed to separately manage commercial and residential wastes; for example, commercial units may generate a large volume of cardboard that cannot be accommodated in MGB-based collection systems
- the need for service lifts (or a goods lift) to transfer waste from the various building floors to the waste storage area(s).



# Mixed-use Development

Guide to Best Practice for Waste Management in Multi-unit Developments

## Best practice garbage and recycling systems and services

### Residential

Examples of best practice waste management in the residential component of mixed-use developments are provided below.

- **Option 1:** Use mobile garbage bins (MGBs) or bulk bins for garbage and recyclables, with bins stored in a communal storage area (see note 1). Residents take all waste and recyclables from their unit directly to the communal storage area.
- **Option 2:** Provide room for interim storage of garbage (in MGBs) and recyclables (in MGBs or crates) on each floor in an interim storage area. A caretaker takes garbage and recyclables from the interim storage area to a communal storage area (see note 1).

*This is more typical in developments of four or more residential storeys.*

- **Option 3:** Install a chute system for garbage, leading to a central garbage room at the bottom of the building. The chute can empty into a bulk bin, an MGB carousel or a compactor (refer to Appendix B for further information on chutes).

Storage of recyclables is in an interim storage area (which also houses the garbage chute inlet hopper) on each floor. A caretaker takes recyclables from the interim storage area to a communal storage area, where recyclables may be stored in either MGBs or bulk bins (see note 1).

*This is more typical in developments of four or more residential storeys.*

Alternatives to Option 3 are to have access to a garbage chute on each floor with a central storage area for recyclables and garbage, for example in the carpark, or to have recycling bins on carpark floors. Both options have implications for building managers with regard to servicing.

The main features of the above systems and their advantages and disadvantages are outlined in Table 7.1.

Note that these systems are provided as examples only and are not intended to constrain good, workable alternatives.

**Note 1:** some councils provide bulk bins for recyclables, such as paper and cardboard; other councils use 240L MGBs for either source-separated or commingled recyclables. In each case, council's waste management unit will advise what the allocation of bins will be according to available MGB or bulk bin sizes.

### Commercial

The garbage and recycling systems installed in commercial developments will vary according the types and quantities of waste and recyclables generated.

This guide does not cover specific waste management requirements for commercial developments, other than how the commercial waste management system should integrate with residential services in mixed-use developments. In general, however, best practice waste management should be achieved by applying the general principles as outlined in Chapter 2 to commercial developments. Appendix A includes some indicative commercial waste generation rates as a guide.



**Table 7.1 Residential component of mixed-use developments – best practice examples**

## Option 1

- 240L MGBs or bulk bins for garbage and recyclables, with bins stored in communal storage area
- Residents carry all waste and recyclables from their unit directly to the communal storage area

Note: this option is only viable in blocks with a smaller number of units.

Advantages	Disadvantages	System requirements
<p>Simple and easy-to-use for both garbage disposal and recycling.</p> <p>Encourages participation in recycling through co-location of garbage and recycling bins.</p> <p>Will still work fairly well without a full-time caretaker if responsibility for moving bins to and from the collection point is clearly defined.</p>	<p>Is less convenient to residents compared with other systems, as they need to carry all garbage and recyclables down to the storage area.</p> <p>May lead to increased contamination of recyclables as residents often use plastic bags to carry their recycling to the waste area, and place both plastic bags and recycling in the recycling bin.</p> <p>Recycling bins could be contaminated if there is inadequate disposal capacity for garbage.</p> <p>Amenity could be reduced if residents carry garbage and recyclables in main lifts and stairwells if there is no service lift.</p> <p>If using MGBs</p> <ul style="list-style-type: none"> <li>■ A large number may be required to service the development. This would require a large storage area (or several smaller areas). It would also require considerable time for ongoing management, including cleaning bins, and moving bins in and out from the collection point.</li> <li>■ Placing a large number of bins on the kerbside for collection is unlikely to be satisfactory to most councils, especially when the ground floor areas are for commercial activity. They can affect street cleaning and visual amenity, and pose risks to pedestrians and motorists by blocking pathways. They can spill their contents and also pose a safety risk to collection operators if they have to manually move bins around cars to the waiting collection vehicle.</li> </ul> <p>If using bulk bins</p> <ul style="list-style-type: none"> <li>■ Decreased ownership may result from sharing bins between greater numbers of units.</li> <li>■ Access for safe and efficient emptying of bulk bins may be limited.</li> <li>■ Bulk bins can be heavy when full and pose a serious health and safety risk if they need to be manually moved.</li> <li>■ On-site collection is generally required, which may not be available in some local areas.</li> <li>■ Potentially higher contamination of recycling if using bulk bins compared with MGBs for recyclables collection.</li> <li>■ Bulk bins are generally suitable for paper and cardboard collection, but not commingled recyclables or source-separated glass due to glass breakage and safety issues during collection.</li> </ul>	<p><b>Storage space and location</b></p> <ul style="list-style-type: none"> <li>■ Communal storage areas that are convenient for residents and servicing arrangements.</li> <li>■ Adequate garbage capacity to reduce contamination of recycling bins.</li> </ul> <p><b>Access for residents and caretakers</b></p> <ul style="list-style-type: none"> <li>■ Storage areas that provide easy access for residents and caretakers to all bins without the need to move bins.</li> </ul> <p><b>Access for collection</b></p> <ul style="list-style-type: none"> <li>■ If using MGBs, identify suitable waste collection point(s) to collect the required number of MGBs that is free from potential obstacles, including parked cars (note, on recycling collection days there may be twice as many bins placed out for collection).</li> <li>■ If using bulk bins, a design that enables efficient on-site collection, with suitable waste collection point(s) to collect bulk bins to eliminate or minimise manual handling as appropriate (refer to general requirements in Chapter 2).</li> </ul> <p><b>Ongoing management</b></p> <ul style="list-style-type: none"> <li>■ Identified responsibilities for cleaning communal areas and bins, educating residents in the appropriate use of systems, and for moving bins in and out of the storage area for collection.</li> <li>■ Clear signs indicating appropriate use of recycling systems.</li> </ul>

# Mixed-use Development

## Option 2

- Interim storage of garbage and recyclables on each floor in interim storage area
- Caretaker takes garbage and recyclables from the interim storage area to a communal storage area
- Waste emptied into MGBs or bulk bins for garbage and recycling used in communal storage area

Advantages	Disadvantages	System requirements
<p>Simple and easy-to-use for both garbage disposal and recycling.</p> <p>Encourages participation in recycling through co-location of garbage and recycling facilities.</p>	<p>Requires regular transfer of garbage and recycling from the interim storage area to the communal storage area.</p> <p>Residents may clutter the interim storage area with bulky unwanted items that then need to be removed by a caretaker or cleaning staff.</p> <p>Requires a degree of ongoing management in transferring bins to and from the collection point on collection day, and keeping the interim storage areas and communal storage area clean.</p> <p>Recycling bins could be contaminated if there is inadequate disposal capacity for garbage in each interim storage area.</p> <p>Amenity could be reduced if residents carry garbage and recyclables in main lifts and stairwells if there is no service lift.</p> <p>If using MGBs in the communal storage area</p> <ul style="list-style-type: none"> <li>■ A large number of MGBs may be required to service the development. This would require a large storage area (or several smaller areas). It would also require considerable time for ongoing management, including cleaning bins, and moving bins in and out from the collection point.</li> <li>■ Large numbers of bins placed out for collection on the kerbside can reduce amenity and pose risks to pedestrians because of blocked pathways. It also poses a safety risk to collection operators if they have to manually move bins around cars to the waiting collection vehicle.</li> </ul>	<p><b>Storage space and location</b></p> <ul style="list-style-type: none"> <li>■ An interim storage area on each floor that holds one or more MGBs for garbage and MGBs or crates for recyclables.</li> <li>■ Space in the interim storage area for at least two days' worth of garbage and recyclables from dwellings on each floor.</li> <li>■ Adequate garbage capacity to reduce contamination of recycling bins.</li> </ul> <p><b>Access for residents and caretakers</b></p> <ul style="list-style-type: none"> <li>■ Access for residents limited to the interim storage area on each floor and the bulky items storage area to help prevent theft and vandalism of bins in communal storage areas, and residents placing full bags of rubbish and other large items in the recycling bins.</li> </ul> <p><b>Access for collection</b></p> <ul style="list-style-type: none"> <li>■ If using MGBs, suitable waste collection point(s) to collect the required number of MGBS that is free from potential obstacles, including parked cars (note, on recycling collection days there may be twice as many bins placed out for collection).</li> <li>■ If using bulk bins, a design that enables efficient on-site collection, with suitable waste collection point(s) to collect bulk bins to eliminate or minimise manual handling as appropriate (refer to general requirements in Chapter 2).</li> </ul>

continues over page



## Option 2 continued

Advantages	Disadvantages	System requirements
<p>Storage of smaller quantities of recyclables in each of the interim storage areas provides an opportunity for caretakers to more closely monitor contamination and identify repeat offenders or the need for further education.</p>	<p>If using bulk bins in the communal storage area</p> <ul style="list-style-type: none"> <li>■ Decreased ownership may result from sharing bins between greater numbers of units.</li> <li>■ Access for safe and efficient emptying of bulk bins may be limited.</li> <li>■ Bulk bins can be heavy when full and pose a serious health and safety risk if they need to be manually moved.</li> <li>■ On-site collection is generally required, which may not be available in some local areas.</li> <li>■ Potentially, there could be higher contamination of recyclables if using bulk bins compared to MGBs for recyclables collection.</li> <li>■ Bulk bins are generally suitable for paper and cardboard collection, but not commingled recyclables or source-separated glass due to glass breakage and safety issues during collection.</li> </ul>	<p><b>Occupational health and safety</b></p> <ul style="list-style-type: none"> <li>■ A suitable system to transfer garbage and recyclables from the interim storage areas that minimises occupational health and safety (OH&amp;S) risks and does not reduce amenity.</li> <li>■ A trolley, with space in the storage room to manoeuvre it, if crates are used for storing recyclables.</li> <li>■ If the transfer of garbage from MGBs into bulk bins is required, a system that minimises or eliminates any OH&amp;S risks.</li> </ul> <p><b>Ongoing management</b></p> <ul style="list-style-type: none"> <li>■ A caretaker to regularly remove garbage and recyclables from the interim storage areas and transfer them to the communal storage area(s); vital to the system's success.</li> <li>■ Identified responsibilities for cleaning communal areas and bins, educating residents in the appropriate use of systems, and for moving bins in and out of the storage area for collection.</li> <li>■ Clear signs indicating appropriate use of recycling systems.</li> </ul>

# Mixed-use Development

Guide to Best Practice for Waste Management in Multi-unit Developments

## Option 3

- Chute system for garbage leads to a central garbage room at the bottom of the building; the chute empties into a bulk bin, MGB carousel or a compactor
- Interim storage of recyclables on each floor in an interim storage area (that also houses the garbage chute hopper)
- Caretaker takes recyclables from the interim storage area to a communal storage area
- Recyclables emptied into MGBs or bulk bins for recycling are used in the communal storage area

Note: the system for garbage needs to be the closest, easiest to use to avoid contamination of recycling bins, and chutes and bins need clear differentiation through the use of different colours and shape of opening.

Advantages	Disadvantages	System requirement
<p>Simple and easy-to-use for both garbage disposal and recycling.</p> <p>Encourages participation in recycling through co-location of garbage and recycling facilities.</p> <p>Storage of smaller quantities of recyclables in each of the interim storage areas provides an opportunity for caretakers to more closely monitor contamination and identify repeat offenders or the need for further education.</p>	<p>Requires regular transfer of recycling and bulky waste items (unsuitable for disposal in the chute) from the interim storage area to the communal storage area.</p> <p>Residents may clutter the interim storage area with bulky unwanted items that then need to be removed by a caretaker or cleaning staff.</p> <p>Chutes are not suitable to transfer recyclables or bulky items, therefore two means of transferring materials in each development are required (the chute and manual methods).</p> <p>Potential contamination of recycling bins if bulky items or other items that cannot fit down chutes are placed in the recycling stream.</p> <p>Amenity may be reduced if residents carry recycling down main lifts and stairwells if there is no service lift.</p> <p>This system requires a high degree of ongoing management to maintain the system: to ensure recycling bins are not contaminated, to transfer bins to and from the collection point on collection day, and to keep the interim storage areas and central garbage room clean.</p> <p>Regular maintenance, including cleaning and unblocking chutes, is likely to be required. Regular inspection of the waste room into which the chute empties is also required to ensure bins do not become overfull.</p> <p>If chutes discharge into a compaction unit, the compacted waste bins can become very heavy and increase OH&amp;S risks. Compacted waste may also get jammed in the base of the bins, making it difficult to empty the contents.</p>	<p><b>Storage space and location</b></p> <ul style="list-style-type: none"> <li>■ An interim storage area on each floor that houses the chute inlet hopper for the garbage chute and MGBs or crates for recyclables. Consult the chute manufacturer about space requirements for the chute opening.</li> <li>■ Space in the interim storage area for at least two days' worth of recyclables from all dwellings on the floor.</li> <li>■ The garbage chute outlet in the central garbage room – the caretaker should not be required to transfer garbage from one side of the building to the other so as to get it from the chute outlet to the garbage room.</li> <li>■ If resident access is restricted to the garbage room, additional garbage MGBs next to the recycling MGBs to avoid contamination of recyclables.</li> </ul> <p><b>Access for residents and caretakers</b></p> <ul style="list-style-type: none"> <li>■ Access for residents limited to the interim storage area on each floor and the bulky items storage area to help prevent theft and vandalism of bins in communal storage areas, and residents from placing full bags of rubbish and other large items in the recycling bins.</li> <li>■ Restricted resident access into garbage rooms where chutes empty, for safety reasons.</li> </ul>





## Storage – space and location

Allow sufficient space to separate garbage and recycling streams in both the commercial and residential waste storage areas.

### Residential waste

#### Communal bin areas

Provide sufficient space in an appropriate location within the building to store all garbage and recyclables likely to be generated in the period between collection days, and the equipment used to manage and store it. There may be more than one storage point.

Consider how the bins are to be emptied and how much room will be required to manoeuvre the bins to where they will be emptied.

#### Bulky items storage

Consider allowing space, adjacent to the waste storage area, for residents to temporarily store unwanted bulky items. Providing storage on-site for the disposal of bulky items is important to stop residents illegally dumping this material on the footpath, which detracts significantly from the quality and appearance of the development.

The space allocated for bulky items storage should consider the intended frequency of collection. Bulky items may be collected by council or contractors. Alternatively, tenants or building managers may make arrangements to take excess bulky items to a waste management centre.

If council provides a bulky items collection, it is important to check the details of the service, as the frequency and the types and sizes of materials collected may differ between local government areas. If on-site collection is not available, employ a caretaker to move bulky items from the interim storage area to the kerbside (or designated collection point).

### Commercial waste

#### Inside each commercial unit

Each commercial unit should have a clearly defined storage space large enough to store at least one day's worth of garbage, recyclables and other wastes generated.

# Mixed-use Development

## Communal storage areas

It is often difficult to predict commercial waste services and infrastructure requirements during the development design stage when the ultimate commercial tenancy of the building is unknown. A further difficulty with sizing communal storage areas is the intended frequency of servicing, which may be daily or less frequent.

An indication of the likely commercial tenancy in a mixed-use development can be obtained by referring to relevant planning controls for the proposed development area, and by considering the available floor space of each commercial unit and similar developments elsewhere.

Commercial premises, such as cafes and restaurants, may generate large amounts of putrescible food organics or high volumes of cardboard and paper (for example offices and retail stores). Appendix A provides typical wastes generated from different commercial operations. If possible, provide space for waste storage areas for commercial units as follows to increase the flexibility and long-term efficiency of servicing:

- If less than five commercial units are proposed
  - › estimate waste generation based on worst-case (highest) likely waste generation, i.e. assume 660L garbage and 240L recycling generated for each 100m<sup>2</sup> of floor area per day
- If greater than five commercial units are proposed
  - › estimate waste generation based on the average waste generation rates for various commercial developments. To determine an 'average' waste generation rate
    - consider the floor space available for each commercial property
    - consider a range of both high and low to medium waste generators, such as restaurants, retail (food), retail (non-food), office and service-based industries (such as hairdressers), which would fit in the available floor space (refer to Appendix A for a range of commercial waste generation rates)

Example: to estimate the waste generated from ten commercial units where the available floor space of each unit is 100m<sup>2</sup> or less, the average garbage generation rate is estimated at 200L/100m<sup>2</sup>/day and the average recycling generation rate is 60L/100m<sup>2</sup>/day based on the following mix of assumed occupancies.

Type of premises	Garbage generation	Recyclables generation
Office	40L/100m <sup>2</sup> floor area/day	80L/100m <sup>2</sup> floor area/day
Butcher/deli/fish shop	80L/100m <sup>2</sup> floor area/day	Information not available
Greengrocer	240L/100m <sup>2</sup> floor area/day	120L/100m <sup>2</sup> floor area/day
Restaurant (1)	660L/100m <sup>2</sup> floor area/day	130L/100m <sup>2</sup> floor area/day
Restaurant (2)	660L/100m <sup>2</sup> floor area/day	130L/100m <sup>2</sup> floor area/day
Takeaway	80L/100m <sup>2</sup> floor area/day	Information not available
Shop with less than 100m <sup>2</sup> floor area (1)	50L/100m <sup>2</sup> floor area/day	25L/100m <sup>2</sup> floor area/day
Shop with less than 100m <sup>2</sup> floor area (2)	50L/100m <sup>2</sup> floor area/day	25L/100m <sup>2</sup> floor area/day
Showrooms	40L/100m <sup>2</sup> floor area/day	10L/100m <sup>2</sup> floor area/day
Hairdresser	60L/100m <sup>2</sup> floor area/day	Information not available
<b>Average</b>	<b>200/100m<sup>2</sup> floor area/day</b>	<b>60/100m<sup>2</sup> floor area/day</b>



## Supporting infrastructure

### Trolleys

If interim storage areas are used in the residential component of the development, identify a suitable system for transfer of recyclables from the interim storage areas that minimises OH&S risks and does not reduce amenity.

If crates are used for storing recyclables, a trolley may be necessary, and the storage room will need to have sufficient space to manoeuvre the trolley.

### Bin lifters

If MGBs containing garbage or recycling need to be emptied into bulk bins, provide equipment to eliminate the need to manually lift and empty the bin.

In this situation, the design of waste storage areas needs to incorporate sufficient space to locate and operate the lifting device. The lifting device should be fitted with safety features to prevent injury to operators, and should be secured to prevent use by residents.

The cost of buying and maintaining the bin lifter and employing a caretaker to operate it should be factored into the ongoing management of the development. Additionally, most councils will only provide one set of bins to a development (i.e. MGBs or bulk bins, but not both), so the cost of an additional set of bins should also be factored in.

Refer to Appendix B for further information about bin lifters and their possible application.

### Service lifts

If a development incorporates interim storage areas on each level for residents, or when there are commercial units on more than one storey, a service lift should be provided to enable the transfer of materials to the relevant communal storage area.

## Access

### For residents

Access for residents to waste facilities should be limited to residential services only; there should be no resident access to commercial waste bins and storage areas.

If interim storage areas are incorporated in residential towers, access for residents to waste facilities should be limited to the interim storage area on each floor and the bulky items storage area. This prevents theft and vandalism of bins in communal storage areas, and also prevents individuals placing full bags of rubbish and other large items in the recycling bins. Resident access should be restricted, for safety reasons, into garbage rooms where chutes empty.

If vandalism or waste dumping is likely to be a serious problem, consider having a secure, centralised lockup area for bulky items.

### For commercial units

Access for commercial operators should be limited to commercial waste bins and storage areas only. There should be no access to residential waste bins and storage areas.

# Mixed-use Development

Guide to Best Practice for Waste Management in Multi-unit Developments

## Ongoing management

All waste management systems in mixed-use developments will require a dedicated caretaker to ensure both residents and commercial tenants are educated and informed about the waste management services provided; maintain the separate residential and commercial waste services, including transferring garbage and recycling receptacles to the collection point; keep waste storage areas clean and free of dumped rubbish; and liaise with the waste collection contractor(s).

The cost of the caretaker should be factored into the ongoing management of the development.

Conditions of consent can require that a development comply with a submitted and approved waste management plan. If a caretaker is required, this should be detailed in the waste management plan; employment of a caretaker will then form part of the conditions of consent, which must be adhered to.

## Example diagrams

The following figures provide examples of the location of bin storage areas for possible mixed-use developments. These examples are a guide only, many other arrangements could be suitable and in accordance with best practice principles. Remember to consult with council engineers, planners and waste managers regarding development requirements specific to a local area.

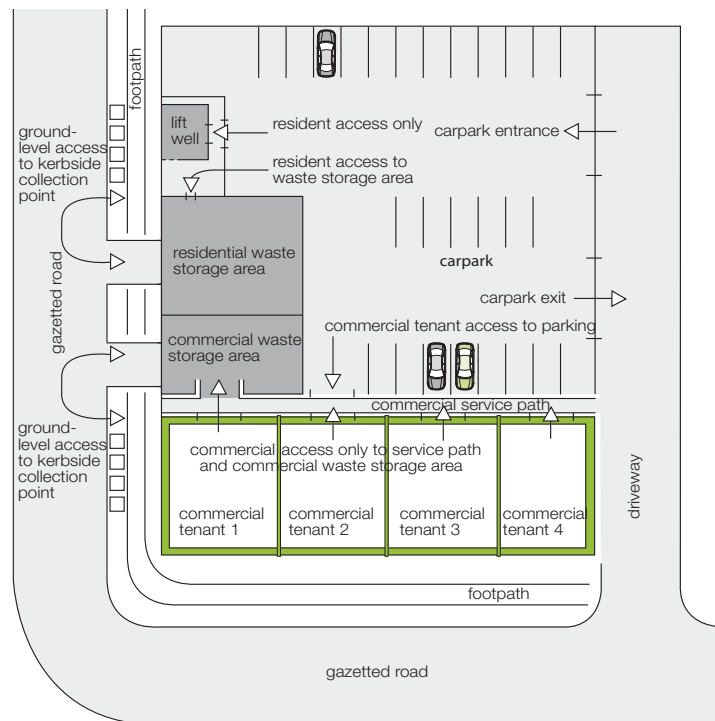
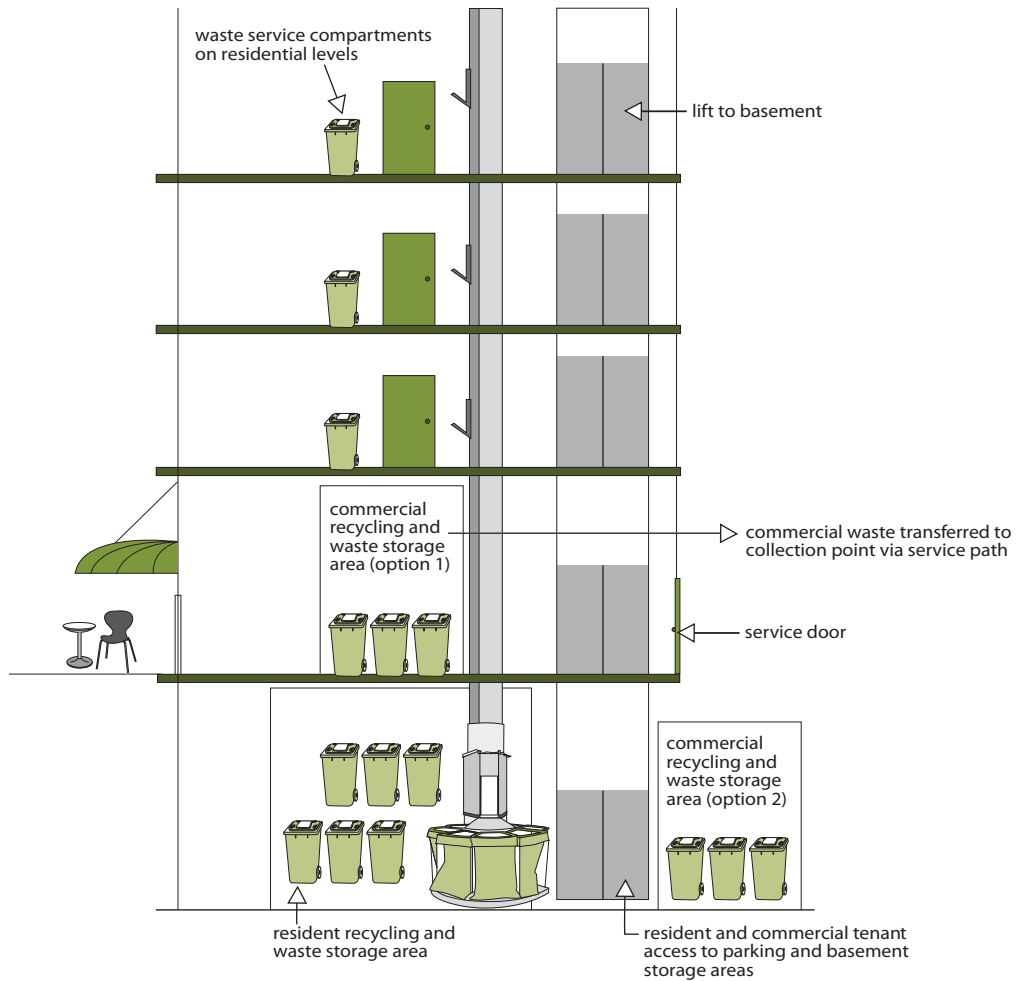

**Figure 7.1 Example of Option 1 or Option 2**

*This example demonstrates separate waste storage areas for residential and commercial waste in a mixed-use development. Resident access to the communal waste storage area is via a passageway adjacent to the residential lift well. Access to the waste room is limited to residents and caretakers only. Only commercial tenants and caretakers can use the commercial waste storage area, as access is via a service area at the rear of the commercial units.*

*Caretakers have additional access to each of the waste rooms directly from the parking area. This is normally kept locked and opened only as required, such as to allow regular cleaning and maintenance of the storage areas.*

*There is ground-level access from both the residential and commercial waste storage areas so the caretaker can easily wheel bins to and from the kerbside for collection.*



**Figure 7.2 Example of Option 3: chute system for residential garbage supported by recycling in MGBs**

*This example demonstrates the potential layout of a secure waste storage area for residents in the basement of a mixed-use development. Access for residents to garbage and recycling facilities is limited to the interim storage area and chute inlet hopper on each residential floor. Access to the rooms where the chute empties and extra bins in the basement is restricted to the caretaker. This is for safety reasons and to discourage dumping.*

*Waste storage areas for ground-floor commercial developments are provided either at the ground level, or in a separate storage area in the building basement.*

*In this example, additional MGBs for garbage are available in the recycling area to prevent contamination of recyclables.*

# Mixed-use Development

Guide to Best Practice for Waste Management in Multi-unit Developments

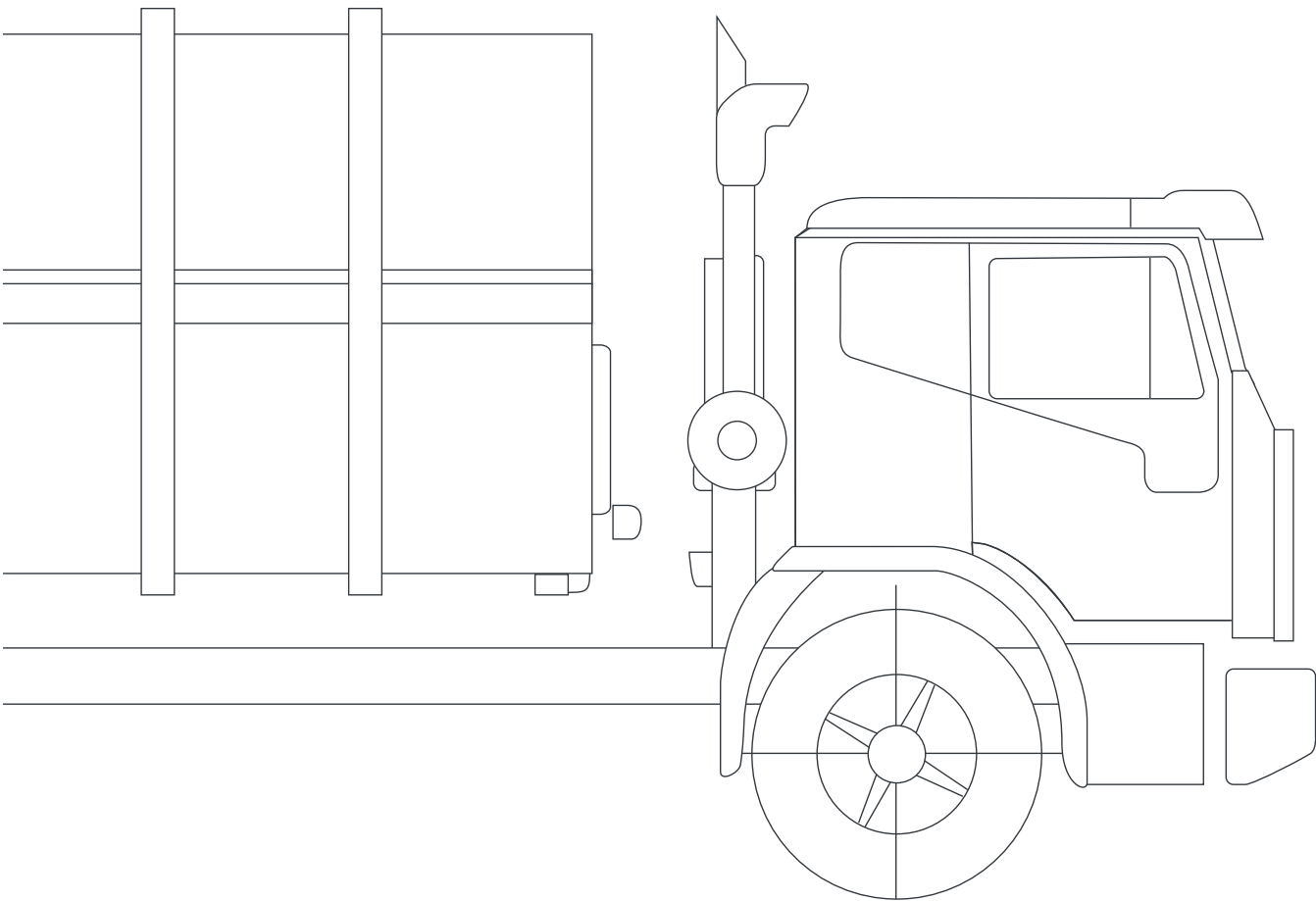

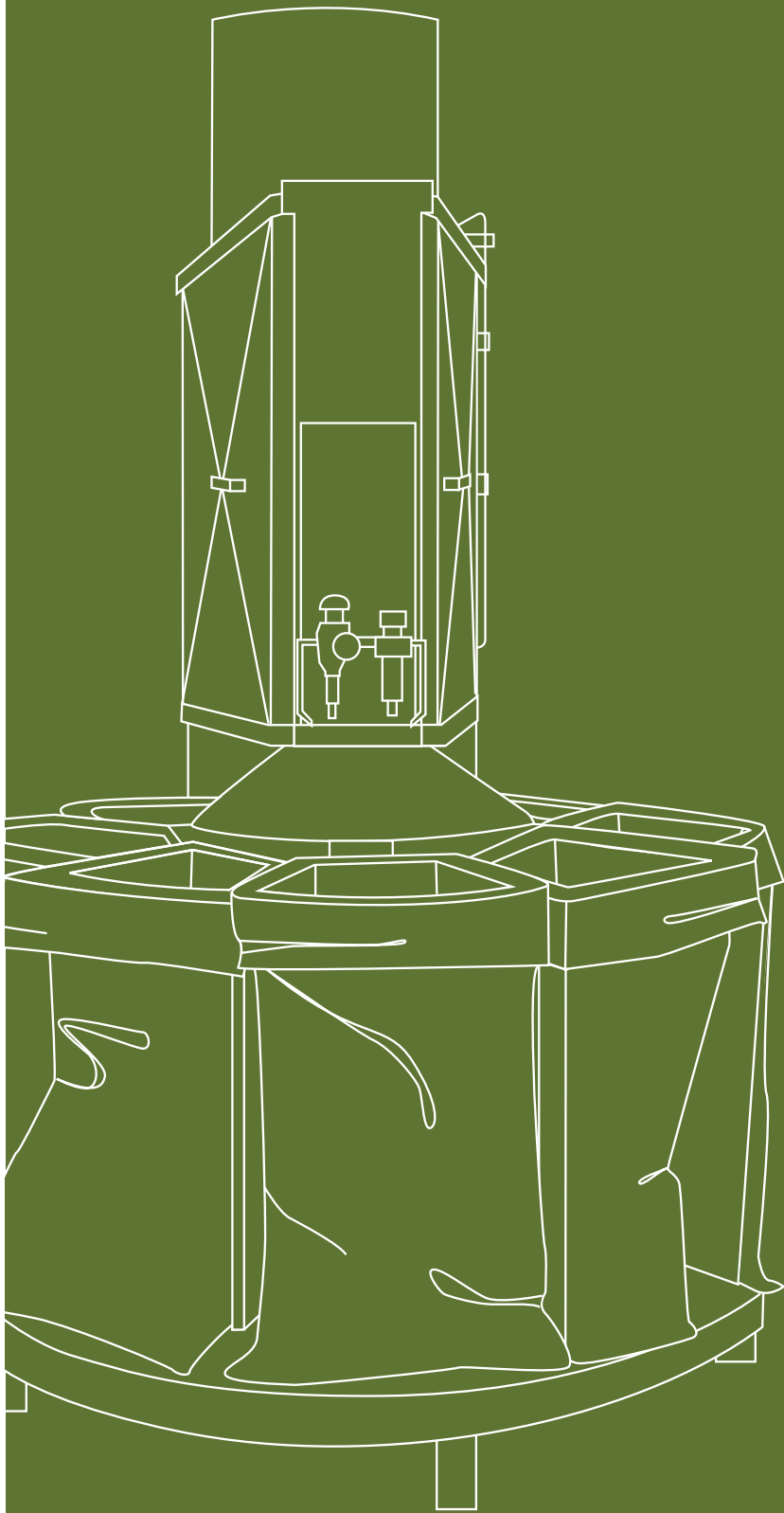

8

Integrated Housing Development

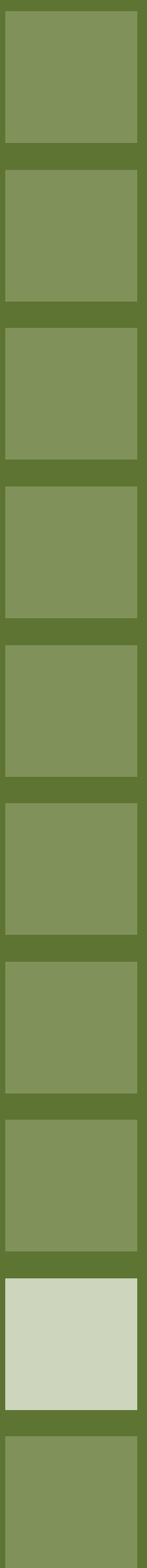



Integrated housing developments incorporate different types of residential dwellings or commercial buildings, including individual houses, multi-unit development (MUDs) and mixed-use developments, on one parcel of land. They often feature internal private access roads and are typically developed into community title-type subdivisions.

## Issues for consideration

The issues discussed in this chapter need to be considered in addition to those applying to all developments as outlined in Chapter 2.

The following principles (for access, storage and ongoing management) should be applied to the integrated housing development as a whole. Please refer to the relevant chapters in this guide for specific requirements for storage as it applies to specific housing types within each of the properties included in the integrated housing development.

### Key problems

Integrated housing developments can include several different types of residential and commercial properties; they may include private roads and shared ways between properties, and there may be limited public street frontage for servicing the development as a whole.

Problems in integrated housing developments therefore typically occur when:

- waste systems have not been designed to accommodate the required waste storage and handling capacity of the total development
- there are problems with access for tenants and collection vehicles to the various parts of the development
- there is no separation of residential and commercial wastes.

### Provision of services

If a private contractor provides the garbage and recycling services, residents may still be required to pay a service availability charge to council as stipulated under section 146 of the *Local Government Act 1993*, and the contractor's fee.

### Waste types and handling methods

In identifying waste handling and storage requirements, consider the:

- proposed location of residential and commercial properties within the development
- likely types of commercial activities that may occur in the development, and the types of waste they may generate (refer to Appendix A)
- number of residential dwellings and residential waste generation (refer to Appendix A)
- waste infrastructure that will be required to separately manage commercial and residential wastes; for example, commercial units may generate a large volume of cardboard that cannot be accommodated in MGB-based collection systems.





# Integrated Housing Developments

Guide to Best Practice for Waste Management in Multi-unit Developments

## Best practice garbage and recycling systems and services

In addition to the principles outlined in Chapter 2, best practice waste management in integrated housing developments requires:

- waste systems in each property within the development that meet individual property needs (for example, waste systems for villas and townhouses will differ from those required in high-rise residential buildings)
- waste management systems, for each building type in the development, that can be effectively serviced and maintained
- complete separation of the residential waste system and any commercial waste management facilities (residential and commercial tenants should be actively discouraged from using each other's waste facilities)
- garbage and recycling systems for the management of commercial wastes that reduce potential adverse impacts on residential units within the development.

### Residential

Depending on the size of the development and the types of residential properties that it includes, it may be necessary to use different garbage, recycling and organics services in the different properties. An integrated development may include, for example, a three-storey building with stairs and a series of villas and townhouses. Waste services used in each of these buildings may be different.

Garbage, recycling and organics services should be incorporated in accordance with the best practice system of both the individual property (as specified in the relevant chapters in this guide) and the development as a whole (as specified in this chapter), particularly for access and servicing. Each resident in an integrated development, regardless of the type of unit complex that they are a part of (villa versus high-rise, for example), should have equal and efficient access to garbage and recycling services.

Refer to relevant chapters in this guide for further information about best practice systems in different types of residential MUDs.

### Mixed use developments

Garbage and recycling systems installed in mixed-use developments within integrated housing developments should conform to the principles outlined in Chapter 7.

## Access

Service requirements that influence the design of the integrated housing development as a whole, such as heavy vehicle access through the development to service each building (if applicable), need to be considered.

Construct any roads or pavements within the development that council garbage and recycling vehicles will drive on to allow for large heavy vehicles (such as carparking areas, landscaping and overhead construction), and design road geometry and strength accordingly, or council will need to be indemnified against potential damages.

Design roads so the collection vehicles do not have to reverse.

Refer to Appendix D for further information on vehicle access requirements.



## Storage – space and location

Provide each property within the integrated development with adequate storage inside individual building areas, in communal storage areas, and for bulk items, in accordance with the general principles for the different development categories as outlined in this guide.

Locate storage areas so they are easily accessible by all residents.

Depending on the layout of the integrated development and property management structure, it may be possible to use shared communal storage areas between properties; if not, provide separate storage within each property boundary. Regardless, storage space and the location of storage should still meet the general principles outlined in Chapter 2 and other relevant chapters of this guide.

## Waste collection point

Identify suitable waste collection points for the development. Depending on the size of the development, there may need to be several collection points that use both kerbside and on-site collection.

Consider if there will be a need for waste collection to access private roads, and design road geometry and strength accordingly.

Lack of footpaths, the presence of narrow streets, and cars parked on internal roads within integrated developments can also be problematic and should be addressed in the development design to enable suitable kerbside collection points (if appropriate).

Particular care should be taken in selecting the location of the collection point(s) where there are narrow or one-way streets throughout the development. Bins placed for collection in one-way streets will need to be on the passenger's side of the street to enable a side-lift collection vehicle to safely uplift the bins. Parking restrictions may also need to be put in place throughout the development to allow for safe movement of collection vehicles in space-restricted areas.

If bins are to be collected from a communal presentation area located at the entrance to the development, consider:

- the area's visual amenity
- providing adequate space for the efficient management of services
- how to collect the bins
- how to transport the bins to and from the communal presentation area.

Collection requirements for an integrated development should be discussed with council at the early planning and design phase.

# Integrated Housing Developments

Guide to Best Practice for Waste Management in Multi-unit Developments

## Example diagrams

The following figures provide examples of the location of bin storage areas for possible integrated developments. These examples are provided as a guide only, many other arrangements could be suitable and in accordance with best practice principles. Remember to consult with council engineers, planners and waste managers regarding development requirements specific to a local area.

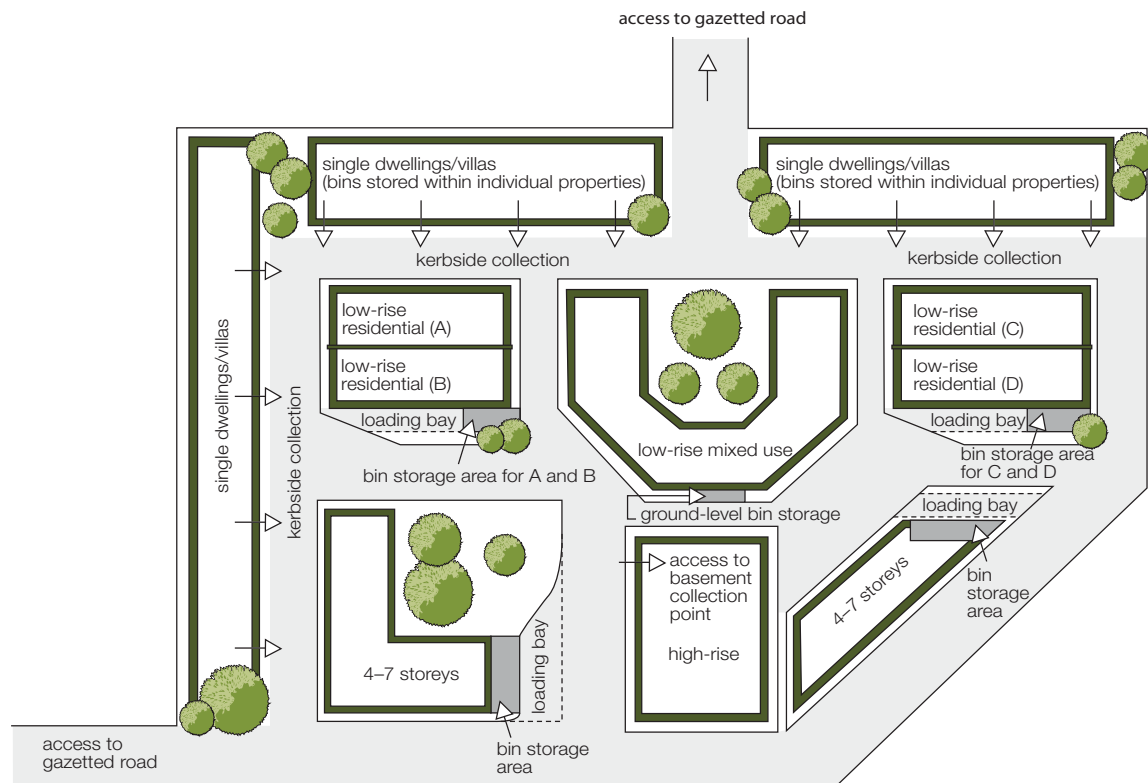

**Figure 8.1 Example of possible collection options within an integrated development**

*This example demonstrates on-site collection of bins from an integrated development that has very limited access and no direct street frontage. The integrated development consists of several different residential developments and a mixed-use development.*

*Bins from the single dwellings and villas located on the northern and western sides of the development are collected from the kerbside of internal roads. Communal bin storage areas are incorporated into each low-rise and four- to seven-storey development, with communal storage areas located adjacent to a dedicated waste loading/unloading bay. This enables collection crews to safely pull up to the property and wheel bins in and out of the adjacent storage area to the waiting vehicle, removing the need for bins to be placed on the kerbside, which is difficult for this number of units.*

*Waste from the high-rise development in this example is collected on site from the basement storage area.*

# Integrated Housing Developments

Guide to Best Practice for Waste Management in Multi-unit Developments

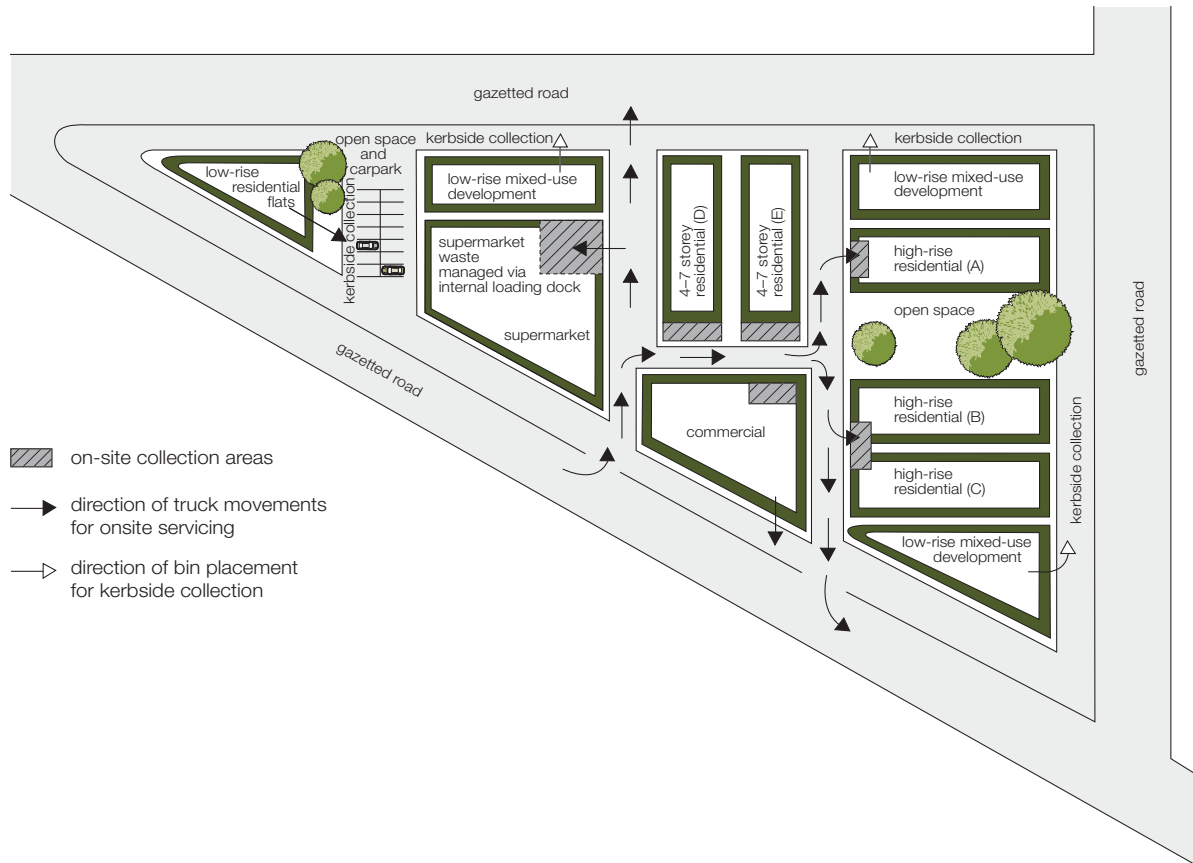

**Figure 8.2 Example of possible collection options within an integrated development**

*This example demonstrates collection of bins from an integrated development that has limited internal access but some street frontage. The integrated development consists of several different residential, mixed-use and commercial developments.*

*Collection requirements are met through a mixture of on-site servicing and kerbside collection of bins. The mixture of on-site and off-site collection minimises the movement of collection vehicles within the narrow streets of the development.*

# Integrated Housing Developments

Guide to Best Practice for Waste Management in Multi-unit Developments

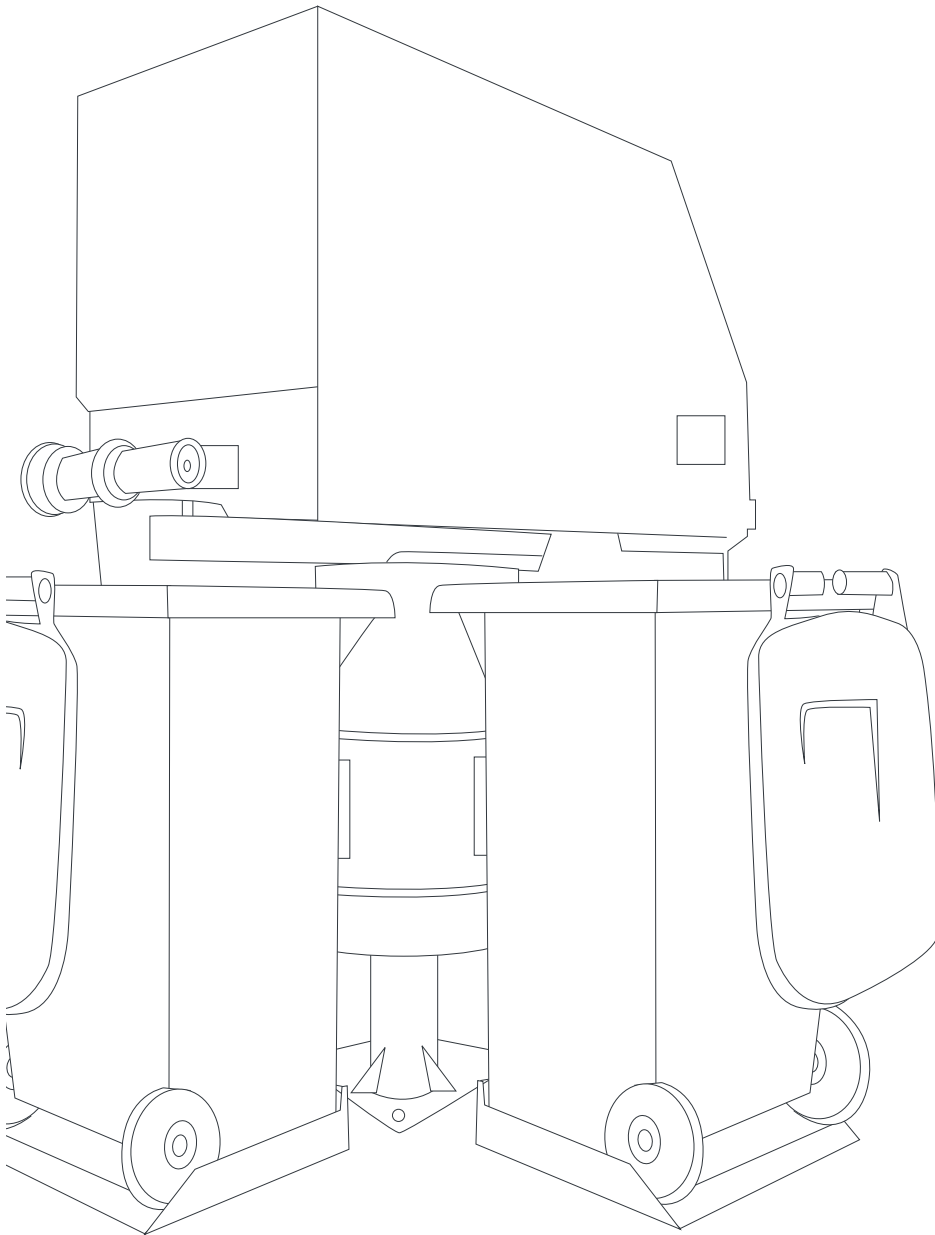

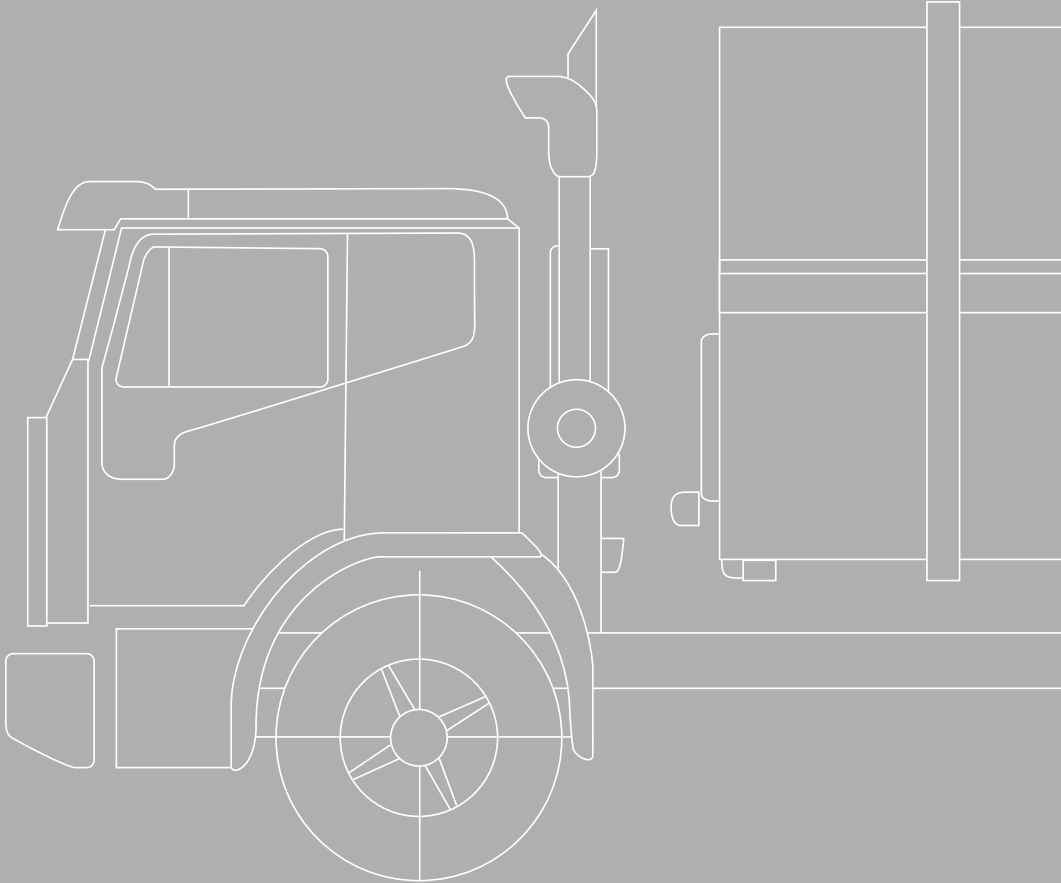

Appendices

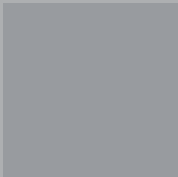
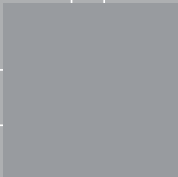
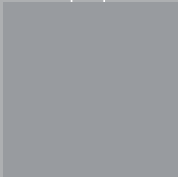
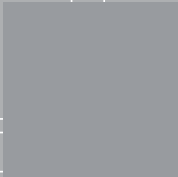
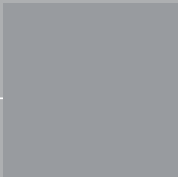
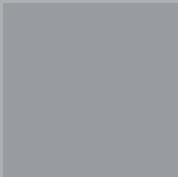
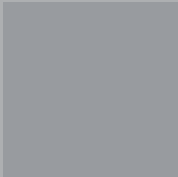
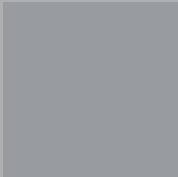
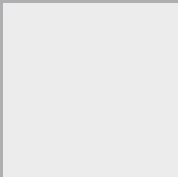

# Appendix A

## Waste Generation Rates (MUDs)

### Domestic waste

A domestic waste study by the Southern Sydney Waste Board in 2001 (**note that domestic waste generation rates for Victoria will be updated in late 2010**) found that the average total generation of waste is approximately 8.5kg/unit/week. Of this, about 6.4kg/unit/week is garbage and 2.1kg/unit/week recyclables.

Volume/weight conversion figures supplied by the NSW EPA are 0.131 t/m<sup>3</sup> for uncompacted domestic waste and 0.262 t/m<sup>3</sup> for compacted domestic waste. Allowing for variance and increase in waste generation, as a RULE OF THUMB, the allowance for waste storage for multi-unit developments (MUDs) should be:

Waste stream	Allowance
Garbage	80 L/unit/week
Commingled recycling	40 L/unit/week
If paper and containers collected separately	
Paper recycling	25 L/unit/week
Containers recycling	15 L/unit/week

# Appendix A

## Guide to Best Practice for Waste Management in Multi-unit Developments

The following commercial waste generation rates were established by the Combined Sydney Region of Councils.

Type of premises	Garbage generation	Recycling generation
<b>Food premises</b>		
Butcher	80L/100m <sup>2</sup> floor area/day	Information not available
Delicatessen	80L/100m <sup>2</sup> floor area/day	Information not available
Fish shop	80L/100m <sup>2</sup> floor area/day	Information not available
Greengrocer	240 L/100m <sup>2</sup> floor area/day	120L/100m <sup>2</sup> floor area/day
Restaurants	660L/100m <sup>2</sup> floor area/day	130L/100m <sup>2</sup> floor area/day
Supermarkets	660L/100m <sup>2</sup> floor area/day	240L/100m <sup>2</sup> floor area/day
Takeaway	80L/100m <sup>2</sup> floor area/day	Information not available
<b>Retail (non-food sales)</b>		
Shops with less than 100m <sup>2</sup> floor area	50L/100m <sup>2</sup> floor area/day	25L/100m <sup>2</sup> floor area/day
Shops with over 100m <sup>2</sup> floor area	50L/100m <sup>2</sup> floor area/day	50L/100m <sup>2</sup> floor area/day
Showrooms	40L/100m <sup>2</sup> floor area/day	10L/100m <sup>2</sup> floor area/day
Hairdresser	60L/100m <sup>2</sup> floor area/day	Information not available
<b>Other</b>		
Backpacker accommodation	40L/occupant/week	20L/occupant/week
Boarding house/guesthouse	60L/occupant/week	20L/occupant/week
Offices	10L/100m <sup>2</sup> /day	10L/100m <sup>2</sup> /day
Hotel	5L/bed/day 50L/100m <sup>2</sup> floor area/day 660L/100m <sup>2</sup> dining area/day	50L/100m <sup>2</sup> of bar and dining areas/day
Licensed club	50L/100m <sup>2</sup> floor area/day	50L/100m <sup>2</sup> of bar and dining areas/day
Motel (without public restaurant)	5L/bed/day 660L/100m <sup>2</sup> dining area/day	1L/bed/day



## Examples of how to calculate garbage and recycling bin storage area requirements

**Note:** Councils may provide a standard number of bins to the development based on the number of units and the bin sizes used for local services. The following examples that calculate the number of bins required are provided as examples only. Consult with council engineers and waste managers to find out about local services and the likely number of bins to be accommodated in waste storage areas.

### Example 1: Sizing of a communal storage area used for garbage and recycling bins that service twelve units

Standard council services are 240L bins for garbage, a separate 240L bin for paper and cardboard and a 240L bin for containers. The development is also provided with one 240L bin for garden organics. Garbage is collected weekly. Recyclables and organics are collected fortnightly.

#### 1. Estimate number of garbage bins required

Waste generated = 12 units x 80L/unit/week = 960L/week  
 Number of garbage bins required = 960L/week ÷ 240L/week (weekly garbage collection)  
 = 4

#### 2. Estimate number of recycling bins required

**Note:** As the 240L recycling bins are collected fortnightly, the equivalent weekly storage capacity is only 120L, hence this figure is used in the calculations to identify the number of recycling bins required.

Paper and cardboard generated = 12 units x 25L/unit/week = 300L/week  
 Number of recycling bins required = 300L/week ÷ 120L/week (fortnightly recycling collection)  
 = 3

Containers generated = 12 units x 15L/unit/week = 180L/week  
 Number of recycling bins required = 180L/week ÷ 120L/week (fortnightly recycling collection)  
 = 2

#### 3. Estimate number of organics bins required

Garden organics bins required = 1 (chosen by council in this example)

#### 4. Total number of bins required

Garbage	4
Recycling – paper and cardboard	3
Recycling – containers	2
Organics	1
<b>Total</b>	<b>10*</b>

**\*Note:** this does not include allowance for contingency/spare bins

#### 5. Bulky items storage

Given the relatively small number of units in the development, it is decided that bulky items storage should not be provided for this development.

# Appendix A

Guide to Best Practice for Waste Management in Multi-unit Developments

## Possible communal area layout

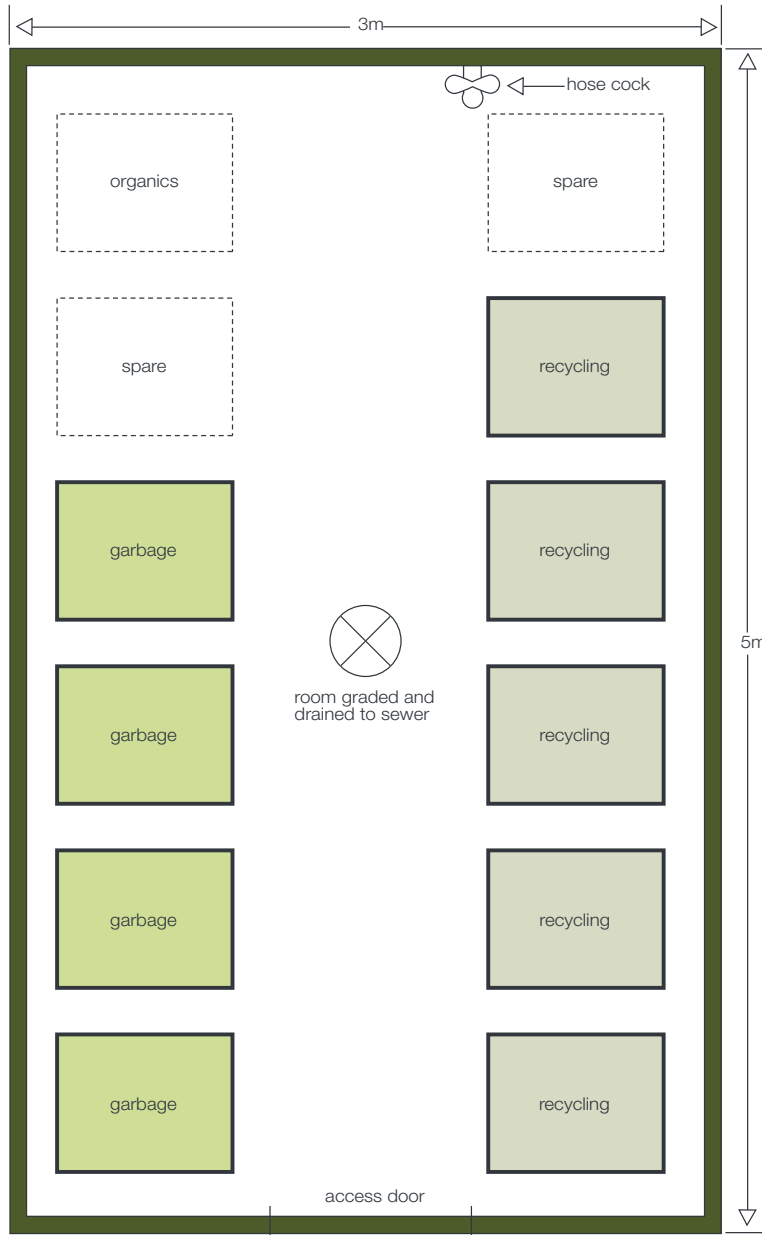

Scale 1:30

## Example 2: Sizing of a communal storage area used for garbage and recycling bins that service 24 units

Standard council services are 240L bins for garbage and 240L bins for commingled recyclables. Garbage and recyclables are collected weekly.

The development is not provided with a garden organics service, as open space and garden areas are limited. A gardening contractor removes any garden prunings from the site that are generated during routine maintenance.

### 1. Estimate number of garbage bins required

Waste generated = 24 units x 80L/unit/week = 1920L/week  
 Number of garbage bins required = 1920L/week ÷ 240L/week (weekly garbage collection)  
 = 8

### 2. Estimate number of recycling bins required

Commingled recyclables generated = 24 units x 40L/unit/week = 960L/week  
 Number of recycling bins required = 960L/week ÷ 240L/week (weekly recycling collection)  
 = 4

### 3. Estimate number of organics bins required

Garden organics bins required = 0  
 (determined by building management in consultation with council)

### 4. Total number of bins required

Garbage	8
Recycling	4
Organics	0
<b>Total</b>	<b>12*</b>

**\*Note:** this does not include allowance for contingency/spare bins

### 5. Bulky items storage

It is decided to provide an allowance of 15m<sup>2</sup> bulky items storage for this development.

**Note:** storage areas for bulky items should be provided in multi-unit dwellings. To calculate the size of the storage area, consider: the number of units in the building; the frequency between collections of bulky items; and the anticipated turnover of residents. A figure of 15m<sup>2</sup> is provided here as an example only – this area may not be applicable to all developments accommodating 24 units.

# Appendix A

Guide to Best Practice for Waste Management in Multi-unit Developments

## Possible communal area layout



OR

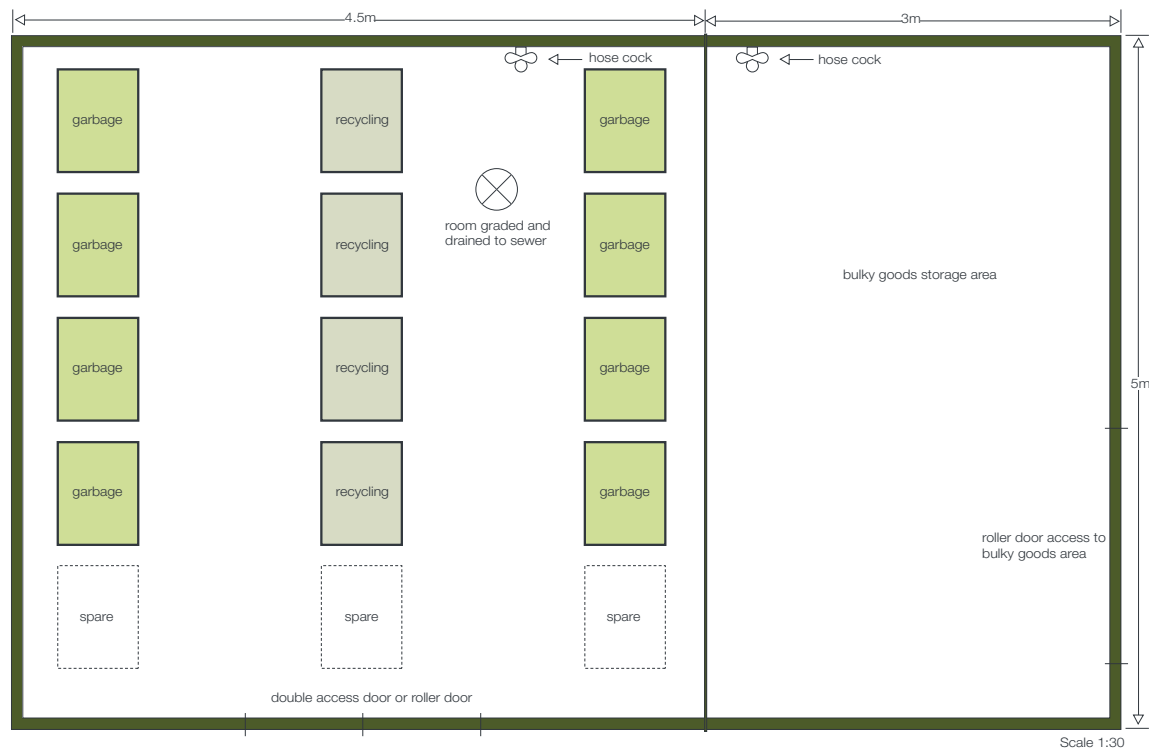

### Example 3: Sizing of a communal storage area used for garbage and recycling bins that service 36 units

Garbage services to the development are provided using 1.5m<sup>3</sup> skips. Commingled recyclables are collected in 240L mobile garbage bins (MGBs). Garbage and recyclables are collected weekly.

The development is provided with a garden organics service consisting of two 240L MGBs, which are collected fortnightly.

#### 1. Estimate number of garbage bins required

Waste generated = 36 units x 80L/unit/week = 2880L/week  
 Number of garbage bins required = 2880L/week ÷ 1500L/week (weekly garbage collection)  
 = 2

#### 2. Estimate number of recycling bins required

Commingled recyclables generated = 36 units x 40L/unit/week = 1440L/week  
 Number of recycling bins required = 1440L/week ÷ 240L/week (fortnightly recycling collection)  
 = 6

#### 3. Estimate number of organics bins required

Garden organics bins required = 2 (determined by council in this example)

#### 4. Total number of bins required

Garbage (skips)	2
Recycling (MGBs)	6
Organics (MGBs)	2
<b>Total</b>	<b>10*</b>

**\*Note:** this does not include allowance for contingency / spare bins

#### 5. Bulky items storage

It is decided to provide an allowance of 18m<sup>2</sup> bulky items storage for this development.

**Note:** storage areas for bulky items should be provided in multi-unit dwellings. To calculate the size of the storage area, consider: the number of units in the building; the frequency between collections of bulky items; and the anticipated turnover of residents. A figure of 18m<sup>2</sup> is provided here as an example only – this area may not be applicable to all developments accommodating 36 units.

# Appendix A

## Guide to Best Practice for Waste Management in Multi-unit Developments

### Possible communal area layout



OR



### Example 4: Sizing of a communal storage area used for garbage and recycling bins that service 50 units

Garbage services to the development are provided using 240L MGBs. Garbage is transferred from the development to the communal storage area via a chute. The chute discharges waste into an MGB rotating carousel compactor with a compaction ratio of 2:1.

Commingled recyclables are collected in 240L MGBs. Garbage is collected twice per week. Recyclables are collected weekly.

The development is not provided with a garden organics service, as there is limited open space and garden areas. A gardening contractor removes any garden prunings from the site that are generated during routine maintenance.

#### 1. Estimate number of garbage bins required

Waste generated = 50 units x 80L/unit/week = 4000L/week

Equivalent compacted volume of waste = 4000L/week ÷ 2 (compaction ratio)  
= 2000L/week

Waste generated between collections = 2000L/week ÷ 2 collections/week  
= 1000L/collection

Number of garbage bins required = 1000L ÷ 240L  
= 5

#### 2. Estimate number of recycling bins required

Commingled recyclables generated = 50 units x 40L/unit/week = 2000L/week

Number of recycling bins required = 2000L/week ÷ 240L/week (weekly recycling collection)  
= 9

#### 3. Estimate number of organics bins required

Garden organics bins required = 0 (determined by council in this example)

#### 4. Total number of bins required

Garbage	5
Recycling	9
Organics	0
Total	14*

**\*Note:** this does not include allowance for contingency/spare bins

#### 5. Bulky items storage

It is decided to provide an allowance of 20m<sup>2</sup> bulky items storage for this development.

**Note:** storage areas for bulky items should be provided in multi-unit dwellings. To calculate the size of the storage area, consider: the number of units in the building, the frequency between collections of bulky items and the anticipated turnover of residents. A figure of 20m<sup>2</sup> is provided here as an example only – this area may not be applicable to all developments accommodating 50 units.

# Appendix A

## Guide to Best Practice for Waste Management in Multi-unit Developments

### Possible communal area layout

In this example, resident access is restricted to the room housing the garbage chute and rotational compactor. Additional garbage MGBs are therefore provided next to the recycling MGBs to avoid contamination of recyclables. Spare garbage MGBs are also located adjacent to the rotational compactor so the caretaker can replace the full garbage bins (under the compactor unit) as required.

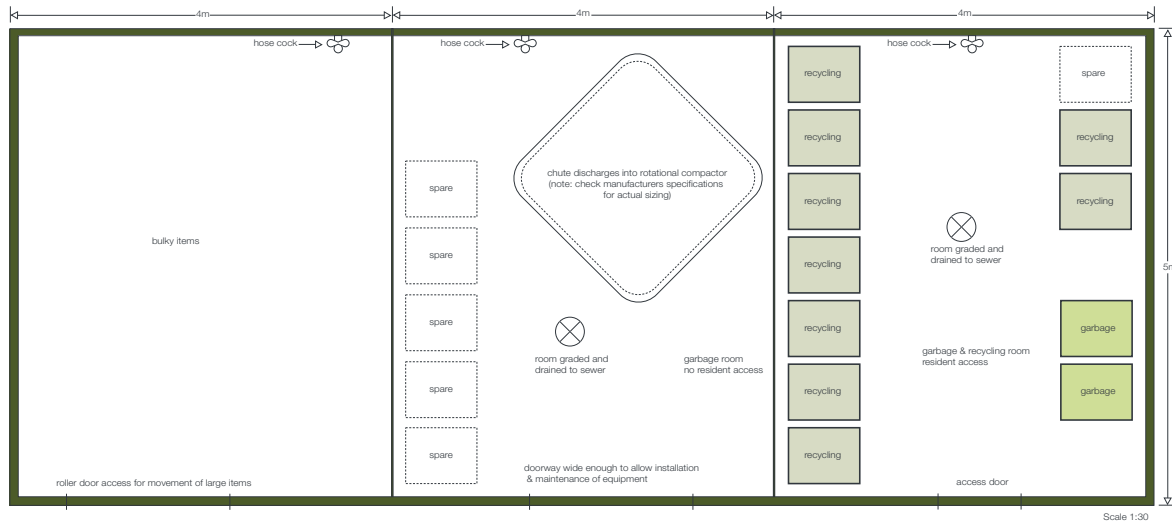



## Appendix B

### Waste Management Equipment

#### Worm farms

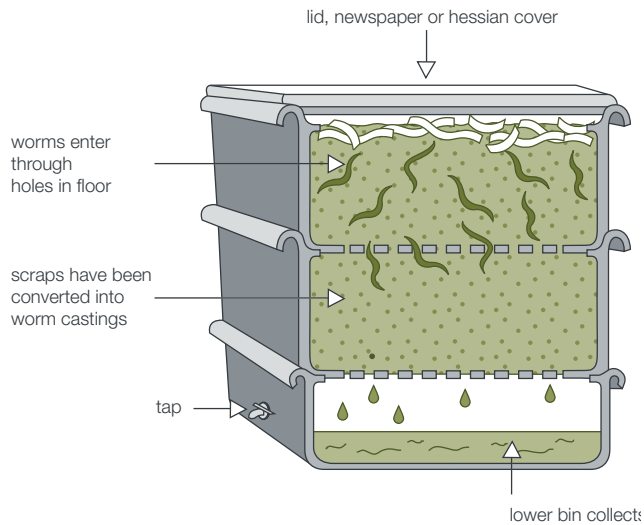

Space requirements for a typical worm farm for an average household:

Height – 300mm per level

Width – 600mm

Length – 900mm

There are many worm farm arrangements. The above dimensions are indicative only.

#### Compost bins and piles

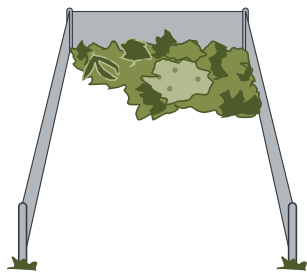

The footprint area requirement for a typical compost pile is 1000m x 1000m.

A variety of compost bins are available from manufacturers or many local councils.

There are many compost bin and compost pile arrangements. The above dimensions are indicative only.

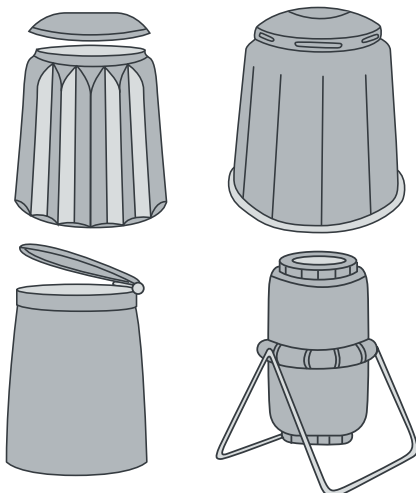

# Appendix B

Guide to Best Practice for Waste Management in Multi-unit Developments

## Crates

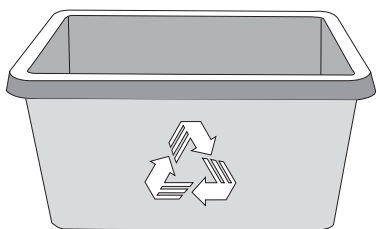

Crate size	50L Crate	70L Crate	90L Crate
Height	320mm	395mm	420mm
Width	445mm	445mm	450mm

The above dimensions are indicative only of common crate sizes

## Mobile garbage bins (MGBs)

MGBs with capacities up to 1700L should comply with the Australian Standard for mobile waste containers, AS 4123. AS 4123 specifies standard sizes and sets out the colour designations for bodies and lids of mobile waste containers that relate to the type of materials they will be used for.

Indicative sizes only for common MGB sizes are provided below. Note that not all MGB sizes are shown; the dimensions are only a guide and differ slightly according to manufacturer, whether bins have flat or dome lids and are used with different lifting devices (refer to AS 4123 for further detail).

### Mobile containers with a capacity from 80L to 360L with two wheels

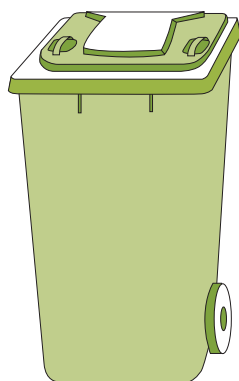

Bin Type	80L MGB	120L MGB	140L MGB	240L MGB	360L MGB
Height	870mm	940mm	1065mm	1080mm	1100mm
Depth	530mm	560mm	540mm	735mm	885mm
Width	450mm	485mm	500mm	580mm	600mm

## Mobile containers with a capacity from 500L to 1700L with four wheels

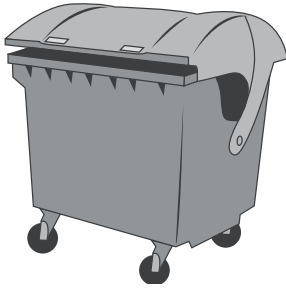

**Dome or flat lid containers**

Bin Type	660L MGB	770L MGB	1100L MGB	1300L MGB	1700L MGB
Height	1250mm	1425mm	1470mm	1480mm	1470mm
Depth	850mm	1100mm	1245mm	1250mm	1250mm
Width	1370mm	1370mm	1370mm	1770mm	1770mm

## Bulk bins greater than 1700L capacity

The following bulk bin dimensions are a guide only and may differ slightly according to manufacturer. Not all available bulk bin sizes are shown.

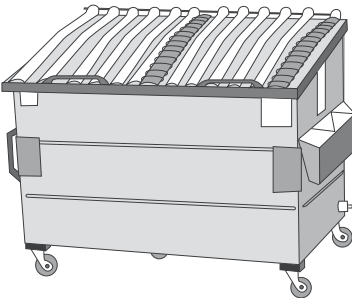

Bin Type	2.0 m <sup>3</sup> Skip	3.0 m <sup>3</sup> Skip	4.5 m <sup>3</sup> Skip
Height	865mm	1225mm	1570mm
Depth	1400mm	1505mm	1605mm
Width	1830mm	1805mm	1805mm

# Appendix B

## Underground bins

Underground bins use hidden capacity by installing large collection containers below ground level. The general user does not see the container but simply a small portion of the container or a small bin above ground.

Underground bins are available in sizes up to 5000L or more. These bins offer the advantage of having a large storage capacity that can effectively manage the waste from many dwellings, with a small, above-ground footprint requirement. Below-ground storage of waste is an advantage, particularly in summer, as the waste is kept cool. The frequency of bin collection may also be reduced significantly, subject to appropriate control of odour and leachate.

A waste collection vehicle that has been modified with a hook-arm or crane typically collects waste from underground bins. The hook attaches to the bin and draws it from the ground. The bin is held over the hopper of the waste collection vehicle and emptied by a trapdoor system or by pulling a cord holding the lining at the base of the bin (this differs between bin manufacturers). An appropriate location for the bin and access for collection vehicles are therefore very important due to the servicing method.

Underground bins are well suited to collect garbage. However, depending on the bin capacity, they may not be as suitable for collecting recyclables as the greater the depth of the bin, the greater the risk of glass breakage when recyclables are dropped in. The bulky nature of cardboard and the weight of source-separated paper may also detract from the suitability of underground bins for recycling. Information and further details of materials that can be managed using this type of bin should be sought from manufacturers.

Note: both dome and litter-bin-type underground bins are collected using a similar overhead crane mechanism. The connection of the bin to a rope may not be required for some automated systems.

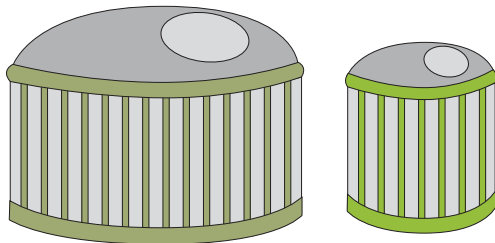

Dome/round type underground bins

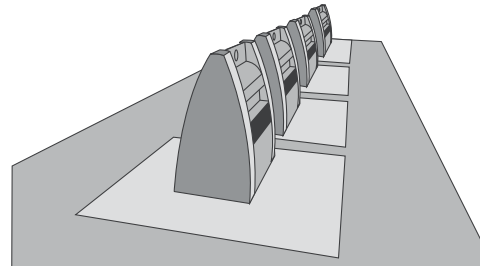

Litter bin-type underground bins

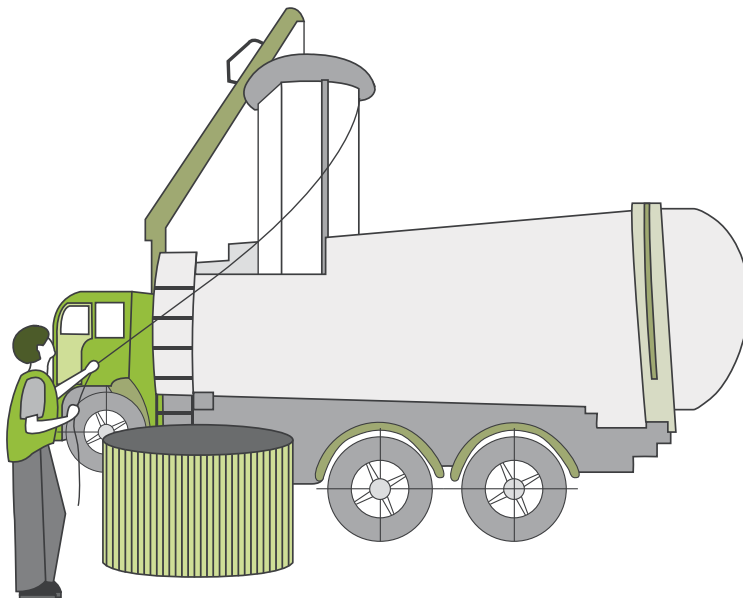

Collection of underground bins

## Chutes

Chutes are suitable to transfer garbage, but not to transfer recyclables. Firstly, the drop generally results in the damage or destruction of the recyclable material – particularly glass. Secondly, cardboard can easily become stuck in the chute and cause a fire hazard. Other recyclables, such as paper and plastics, are also highly flammable. Therefore, having large quantities of recyclables stored at the bottom of a long shaft that runs the height of the building can constitute a fire hazard.

Design chutes to reduce noise and fire risks associated with their use. They should be cylindrical in section to avoid waste being caught within the chute, and with a diameter of 500mm or greater.

Provide a service room (or compartment) on each floor of the development to allow access to the garbage chute. Chutes should not open onto any habitable or public space. Hopper doors are to have an effective self-sealing system.

Chutes should terminate in a garbage and recycling room and discharge directly into a receptacle or waste compactor to avoid spillage and overflow.

Chutes should be completely enclosed in a fire-rated shaft constructed of an approved material and fitted with sprinklers in accordance with the Building Code of Australia.

See manufacturer(s) for exact specifications.

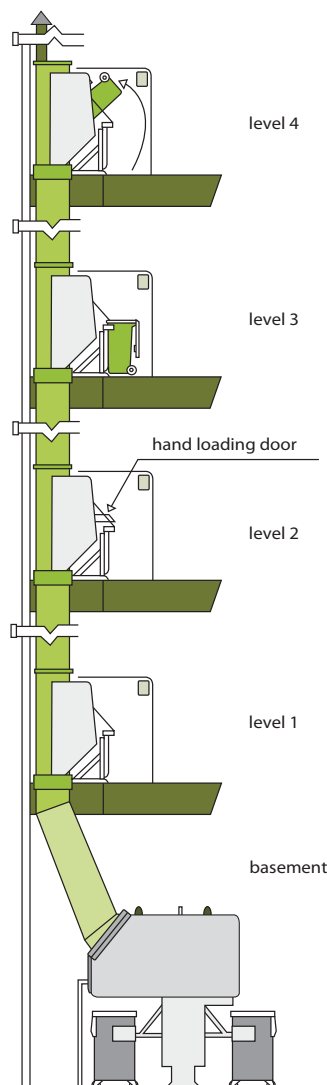

# Appendix B

## Service lifts

A service lift (or service elevator) may be appropriate in place of a waste chute in developments where a caretaker is employed.

A service lift is dedicated to the transport of garbage and recycling containers and other equipment required for the operation of the development.

Provide an interim storage room on each floor of the development to allow residents to store waste and recyclables. Residents place their waste and recyclables in bins provided and these are transported daily by the caretaker to the waste storage room. Each service room needs to be designed with sufficient space for the storage of two days' garbage and recyclables for all residents on that level.

Developers will need to check with council whether this option is acceptable.

## Compactors

Compactors are used to compress the waste (or recyclables) into smaller collection containers. The compaction ratio is typically set at around 2:1. Higher ratios are not used as they may result in heavier bins, causing occupational health and safety (OH&S) problems, mechanical damage and may break recyclable materials. They may also cause compacted waste to get jammed in the base of the bins, making it difficult to empty the contents.

Best practice compaction systems compact directly into a 240L MGB or a skip, reducing the requirement to manually load the compacted waste into bins or skips.

Compactors are extremely useful for mixed garbage or cardboard/paper or plastic/aluminium containers. They are less useful for steel containers and should not be used for glass.

Compactors require regular maintenance. In particular, systems fed from a chute can be prone to blockages or failure of the 'electronic eye', which can result in garbage overflowing or backing up the chute.

The 2:1 compaction ratio will halve the requirement for garbage storage bins.

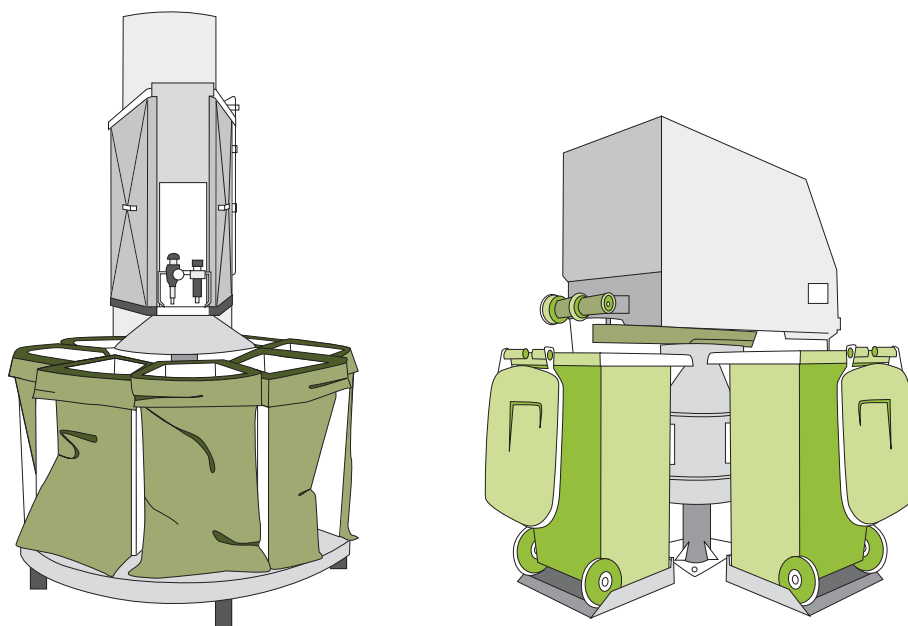

**Rotational (carousel) compactors**

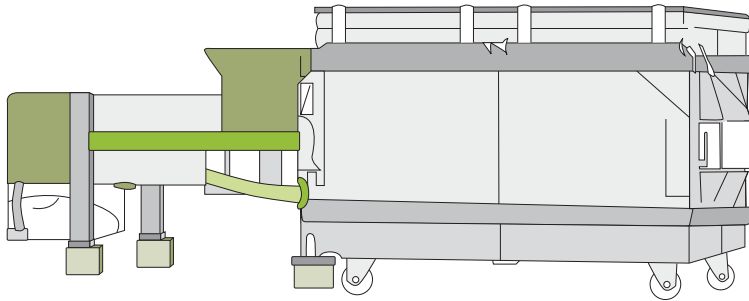

## Static compactors

## Bin lifters

If MGBs need to be emptied into bulk skips or compactors, provide a hydraulic bin-lifting device to eliminate the need for manual lifting.

Bin lifters are available for a variety of tipping applications, including various size bins and containers, and designed to tip into containers of various heights. They can be battery powered or connected to mains power. Some models also come with safety cages.

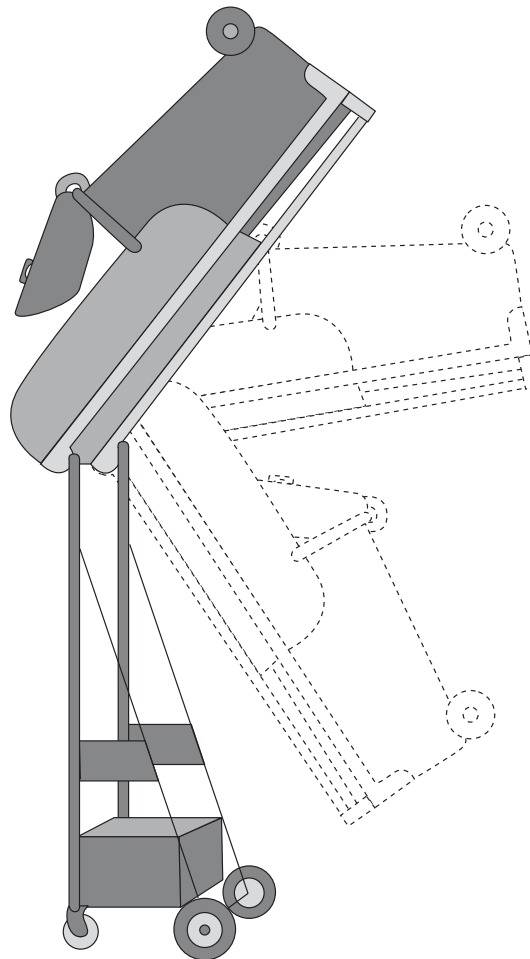

# Appendix B

## In-sink food waste disposal units

An in-sink food waste disposal unit is an electrical and mechanical appliance that is installed under the kitchen sink and connected to the drain. Food waste is fed into the unit which grinds the food waste until it is small enough to flow through the pipes and into the sewage system or septic tank.

Some councils and local water authorities do not support the use of this technology due to the increased load it places on the sewage system and because it could detract from organics recovery objectives.

Before incorporating an in-sink food waste disposer unit in MUDs:

- liaise with council to investigate what garden and/or food organics collection service will be available to the development
- consult with the local water authority and council to find out if this technology can be installed in the local area.

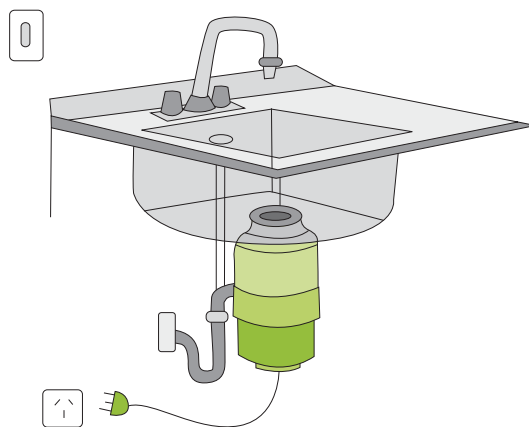



## Appendix C

### Collection vehicles

Waste collection vehicles may be side loading, rear-end loading, front-end loading or crane trucks. The size of vehicle varies according to the collection service. Developers should consult the local council and/or relevant contractors regarding the type of vehicle used in the local area.

The following characteristics represent the typical collection vehicle; however, these are only for guidance.

It may be possible to engage a collection service provider to use smaller collection vehicles to service developments with narrow roadways and laneways, or for on-site collections. However, as the availability of smaller vehicles to make services varies between councils and private contractors, wherever possible, the development should be designed to accommodate vehicles of a similar size to that reported below.

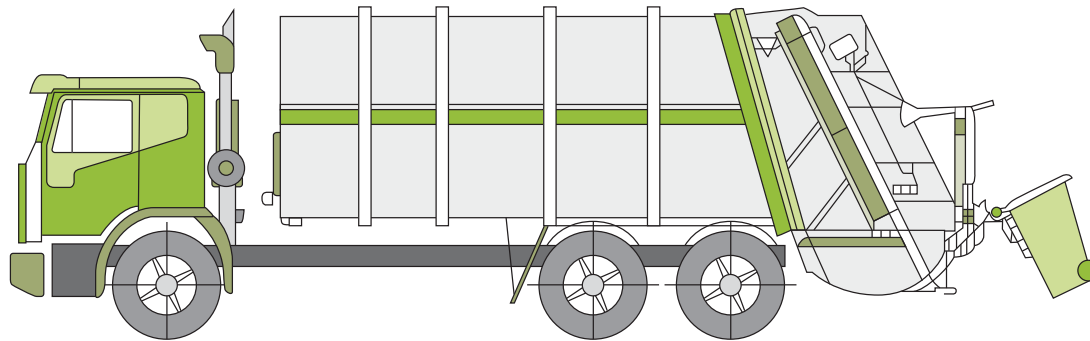

#### Rear loading collection vehicle

Rear loading collection vehicle	
Length overall	10.24m
Width overall	2.5m
Operational height	3.5m
Travel height	3.5m
Weight (vehicle only)	12.4 tonnes
Weight (payload)	9.5 tonnes
Turning circle	18.0m

This is commonly used for domestic garbage and recycling collections from MUDs. It can be used to collect waste stored in MGBs or bulk bins, particularly where bins are not placed on the kerbside.

# Appendix C

## Side-loading collection vehicle

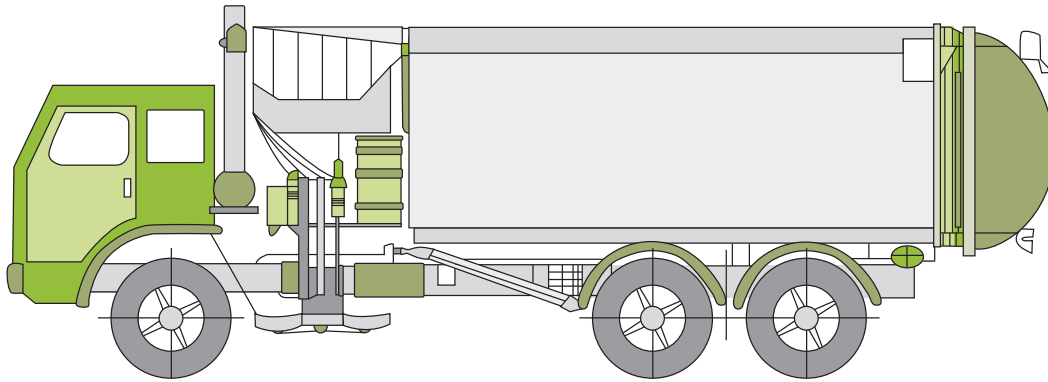

Side-loading collection vehicle	
Length overall	9.64m
Front overhang	1.51m
Wheelbase	5.20m
Rear overhang	2.93m
Turning circle kerb to kerb	17.86m
Turning circle wall to wall	20.56m
Front of vehicle to collection arm	3.8m
Maximum reach of side arm	3.0m
Travel height	3.63m
Clearance height for loading	3.9m

This is the most commonly used vehicle for domestic garbage and recycling collections. It is only suitable for collecting MGBs up to 360L in size.

## Front-lift loading collection vehicle

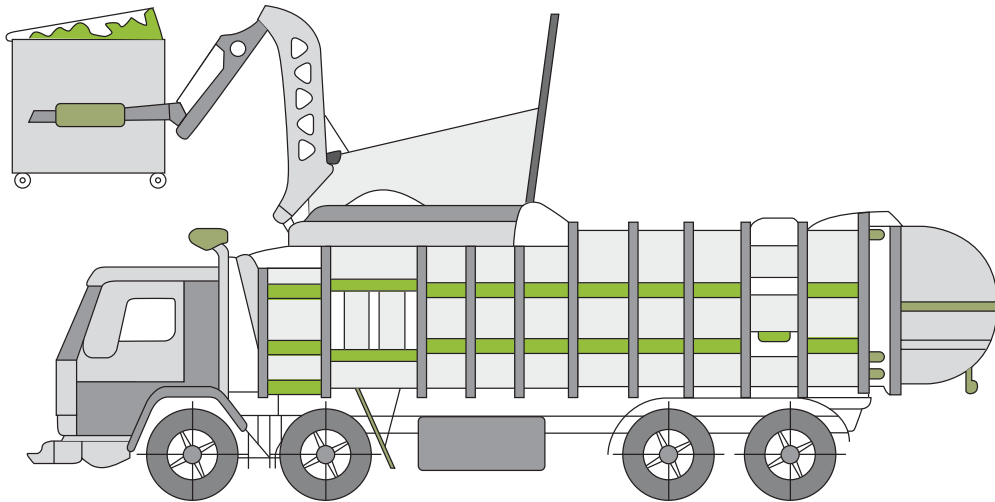

Front-lift loading collection vehicle	
Length overall	10.52m
Front overhang	1.51m
Wheelbase	5.84m
Rear overhang	3.17m
Turning circle kerb to kerb	22.10m
Turning circle wall to wall	23.66m
Travel height	3.82m
Clearance height for loading	6.1m

This is mainly used for collecting commercial and industrial waste, and is only suitable for bulk bins with front lift pockets (not MGBs).

# Appendix C

Guide to Best Practice for Waste Management in Multi-unit Developments

## Crane trucks

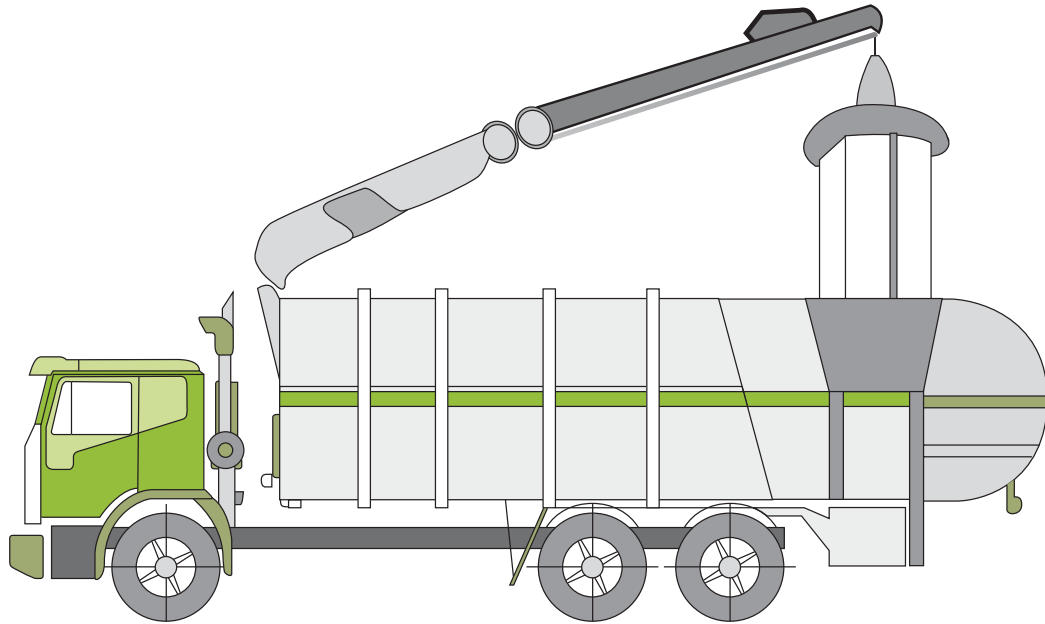

Crane truck collection vehicle	
Length overall	10.0m
Width overall	2.5m
Weight (vehicle only)	13.0t
Weight (payload)	9.5t
Turning circle	18m
Travel height	3.8m
Clearance height for loading	8.75m

This type of truck is used to collect underground bins.

# Appendix D

## Vehicle access/Turning circles

### General

Appropriate heavy vehicle standards should be incorporated into the development design, including those specified in legislation, regulations, guidelines, and codes administered by Austroads, Standards Australia, VicRoads, WorkSafe Victoria and any local traffic requirements.

Designers are encouraged to consult with council and other relevant authorities before the design of roads and access points to determine specific requirements for the proposed development.

### Road and driveway construction and geometry

Roads and driveways must be designed and constructed in accordance with the relevant authority requirements to allow the safe passage of a laden collection vehicle in all seasons.

Factors to consider in design include:

- gradients for turning heads
- longitudinal road gradients
- horizontal alignments
- vertical curves
- cross-falls
- carriageway width
- verges
- pavement widths
- turning areas (see below)
- local area traffic management requirements (for example, speed humps)
- sight distance requirements
- clearance heights (for example, a vertical clearance of 6.5m is required to load front-lift vehicles)
- manoeuvring clearance
- road strength (industrial-type strength pavement is required, designed for a maximum wheel loading of 7t per axle to accommodate garbage and recycling collection vehicles).

# Appendix D

## Collection from basements

Collection vehicles may enter building basements to collect waste and/or recyclables provided the following requirements are met:

- compliance with Australian Standard AS 2890.2 Parking facilities– Off-street commercial vehicle facilities
- the height to the structural members and upper floor ceiling allows for a typical collection vehicle travel height/operational height consistent with the type of vehicle employed
- adequate space clear of structural parts or vehicle parking spaces to allow a typical three-point turn of collection vehicles
- the basement floor is of industrial-type strength pavement and designed for a maximum wheel loading of 7t per axle to accommodate garbage and recycling collection vehicles.

## Vehicle turning circles

Turning circles and clearances to kerbs, existing buildings or other obstructions should be designed to accommodate the largest size collection vehicle that could service the property and must also include allowances for driver steering error (manoeuvring clearance) and overhangs.

As a guide, a turning circle of 25m diameter kerb to kerb (27.8m diameter wall to wall, swept circle)<sup>1</sup> would accommodate most standard waste collection vehicles. A manoeuvring clearance of at least 0.3m (absolute minimum) on both sides of the theoretical swept circle path should be accommodated.

Best practice design calls for a separate entrance and exit to allow the collection vehicle to travel in a forward direction at all times. If collection vehicles need to turn at a cul-de-sac head within a development, the design should incorporate either a bowl, T- or Y-shaped arrangement. Vehicles should only be expected to make a three-point turn to complete a U-turn.

Vehicle turning circles can be reduced by using a mechanical turntable (or similar) equipment. However, this type of equipment comes at an associated cost and requires regular maintenance to ensure it remains in good operating condition.

<sup>1</sup> Kerb-to-kerb measurements are based on the movement of the front outside tyre. Wall-to-wall (swept circle) measurements consider vehicle overhang and are based on the outermost extremity of the vehicle as it corners.

## Templates

Turning circle templates and reverse entry templates for medium and heavy rigid vehicles are available from SAI Global ([www.saiglobal.com](http://www.saiglobal.com)) through its webshop.

- Turning path templates should be used in the design of access driveways and circulation roadways, and in checking on the path of vehicles leaving service bays.
- Reverse entry templates should be used in the design of service bays and service area aprons if vehicles need to reverse to complete a Y-shaped turn.

These templates can be printed and copied onto a transparent medium or imported into computer drawing packages to check vehicle paths on intersection layout drawings.

These templates are applicable for the following vehicle dimensions.

Vehicle class	Overall length (m)	Design width (m)	Design turning radius (m)	Swept circle (m)	Clearance (travel) height (m)
Medium rigid vehicle	8.80	2.5	10.0	21.6	4.5
Heavy rigid vehicle	12.5	2.5	12.5	27.8	4.5

Templates have been sourced from AS 2890.2 Parking Facilities: Off-Street Commercial Vehicle Facilities. Please refer to this standard for the latest vehicle access requirements. This standard is available from SAI Global ([www.saiglobal.com](http://www.saiglobal.com)).

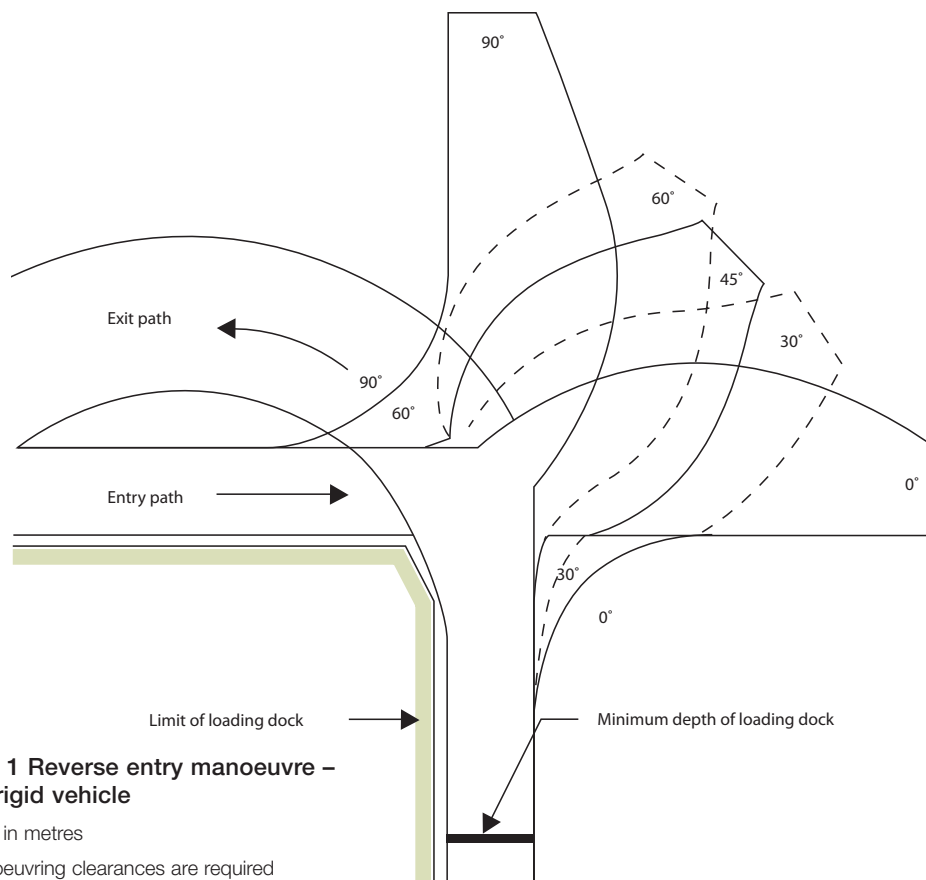

**Template 1 Reverse entry manoeuvre – medium rigid vehicle**

Dimensions in metres

**Note:** manoeuvring clearances are required to be added for design purposes.

# Appendix D

Guide to Best Practice for Waste Management in Multi-unit Developments

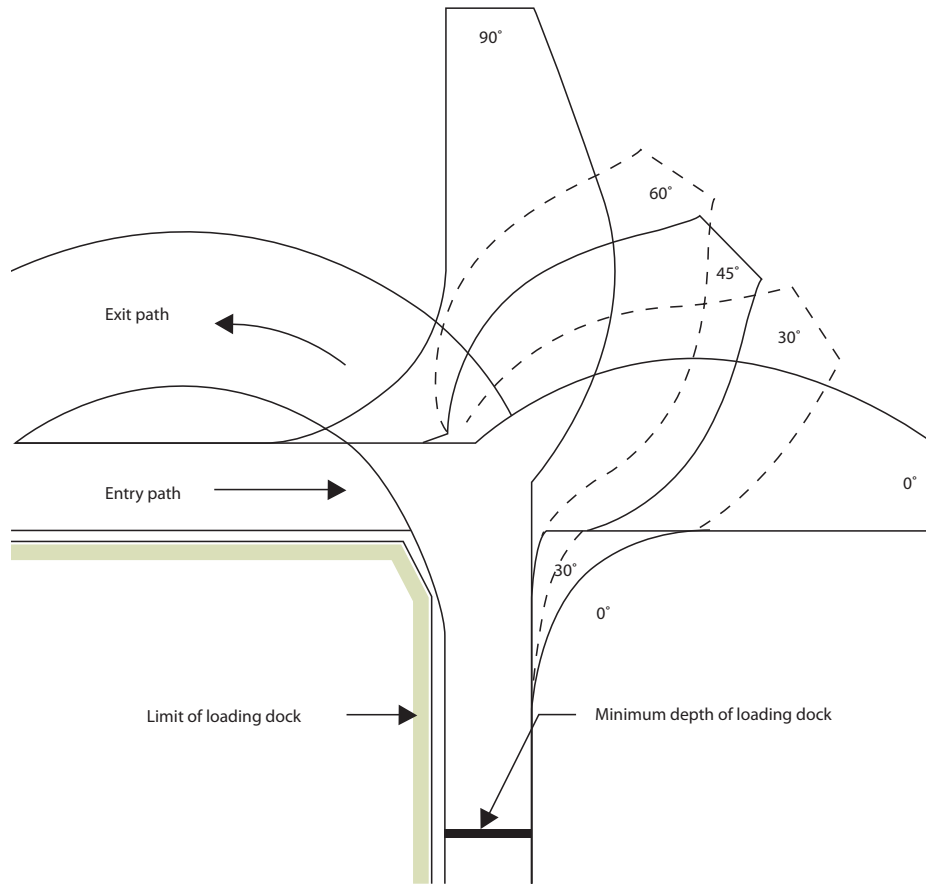

## Template 2 Reverse entry manoeuvre – heavy rigid vehicle

Dimensions in metres

**Note:** manoeuvring clearances are required to be added for design purposes.



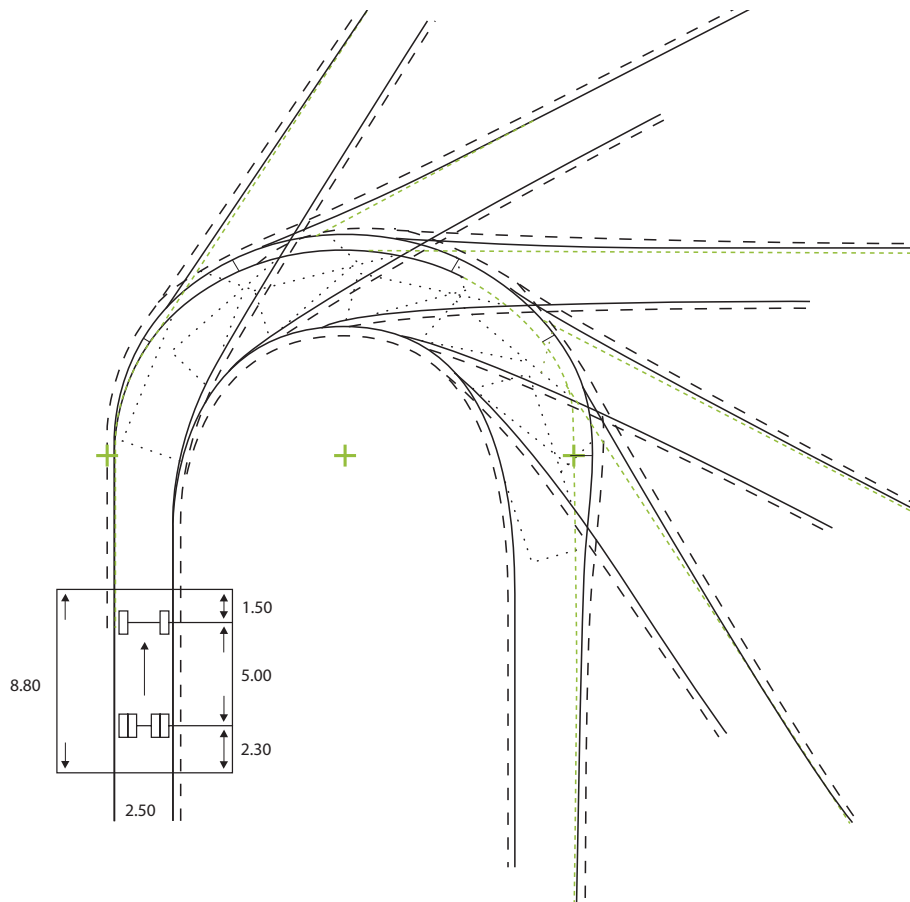

### Template 3 Turning path template – medium rigid vehicle

Dimensions in metres

Minimum radius turn 10m

# Appendix D

Guide to Best Practice for Waste Management in Multi-unit Developments

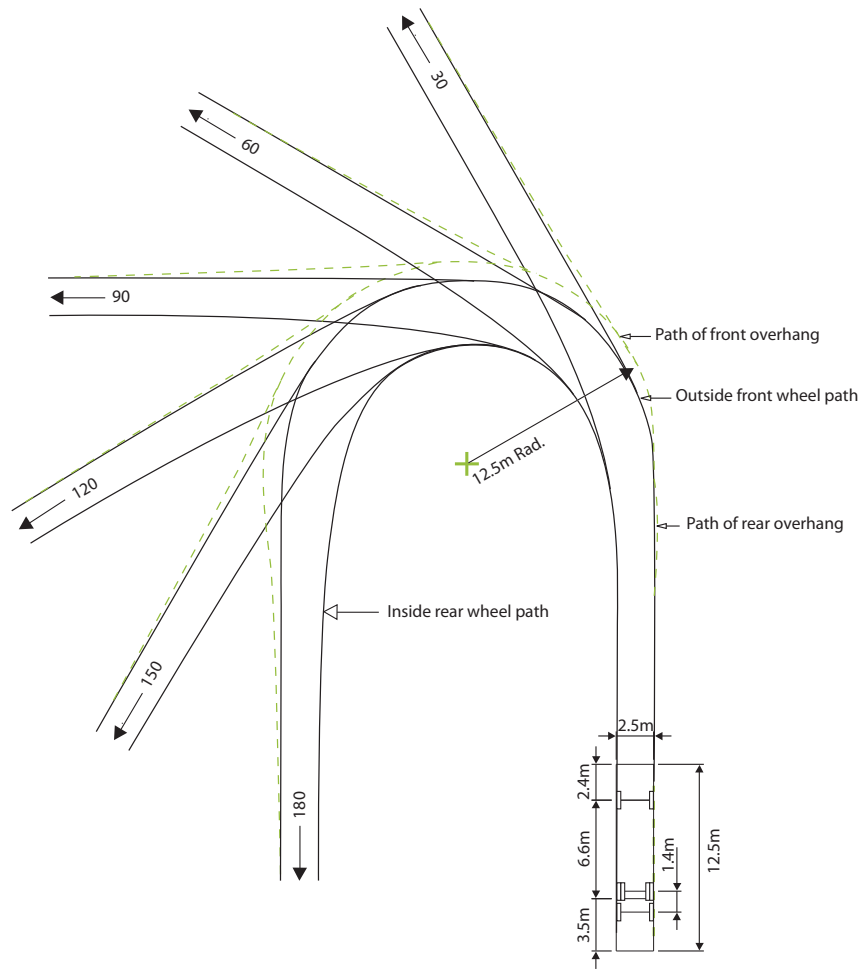

## Template 4 Turning path template – heavy rigid vehicle

Dimensions in metres

Minimum radius turn 10m

## Appendix E

### Standard signage

#### Waste signs

Standard wall posters and bin lid stickers are available for download and printing from the 'Get Informed' section of the 'Sustainability Victoria' website ([www.sustainability.vic.gov.au](http://www.sustainability.vic.gov.au)) in black and white.

#### Example wall posters

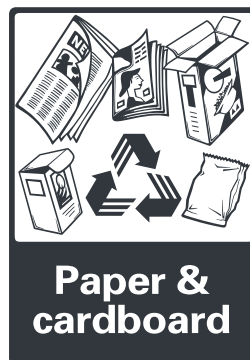

#### Example bin lid stickers



#### Safety signs

The design and use of safety signs for waste rooms and enclosures should comply with AS 1319 Safety signs for the occupational environment. Safety signs should be used to regulate and control safety related to behaviour, warn of hazards and provide emergency information, including fire protection information.

#### Examples of Australian Standards:



Australian Standards are available from the 'SAI Global Limited' website ([www.saiglobal.com](http://www.saiglobal.com)).

## Appendix F

### Checklist

The following checklist has been developed to confirm that the main issues essential for waste management have been considered in the building design. Use this checklist as a tool to ensure best practice principles have been considered in the design of proposed garbage and recycling facilities.

Key issues	Completed	Not applicable
<b>Initial planning</b>		
■ Have planning authorities and council been consulted to find out what planning regulations, codes and policies apply to the development?	<input type="checkbox"/>	<input type="checkbox"/>
■ Has council been asked about available garbage and recycling services, and future service requirements?	<input type="checkbox"/>	<input type="checkbox"/>
<b>Selected garbage and recycling systems (general)</b>		
■ Does the development incorporate sufficient provisions to meet the garbage and recycling requirements for each tenant (both residential and commercial)?	<input type="checkbox"/>	<input type="checkbox"/>
■ Are systems easy to use and intuitive?	<input type="checkbox"/>	<input type="checkbox"/>
■ Will waste bins and containers conform to relevant design standards?	<input type="checkbox"/>	<input type="checkbox"/>
■ Will waste handling equipment, including chutes and compactors, conform to the relevant design and safety standards?	<input type="checkbox"/>	<input type="checkbox"/>
<b>Storage space</b>		
■ Is there sufficient space within each unit to accommodate interim storage of at least two days' segregated garbage and recyclables?	<input type="checkbox"/>	<input type="checkbox"/>
■ Is there sufficient space within the property boundary to store, in separate bins or containers, the volume of garbage and recyclables (and garden organics if appropriate) likely to be generated at the development during the period between collections?	<input type="checkbox"/>	<input type="checkbox"/>
■ Is bulky waste storage space required and has it been allowed for, taking into account potential servicing requirements specific to council?	<input type="checkbox"/>	<input type="checkbox"/>
■ Have storage areas been designed to accommodate easy access for manoeuvring bins and cleaning the storage area(s)?	<input type="checkbox"/>	<input type="checkbox"/>
■ Have storage areas been designed to allow space for signs and education materials to be displayed?	<input type="checkbox"/>	<input type="checkbox"/>
■ Is there allowance for future service flexibility incorporated in the design?	<input type="checkbox"/>	<input type="checkbox"/>
■ In communal storage areas, if applicable, has the design considered the need to separate services (such as meter boards) from waste storage areas? If this is not possible, has additional space been allowed to prevent potential damage to services?	<input type="checkbox"/>	<input type="checkbox"/>
■ Is there room for each unit to have a home worm farm or compost bin?	<input type="checkbox"/>	<input type="checkbox"/>

Key issues	Completed	Not applicable
<b>Storage location</b>		
■ Are storage locations conveniently located for residents?	<input type="checkbox"/>	<input type="checkbox"/>
■ Are storage areas located where there is high pedestrian traffic?	<input type="checkbox"/>	<input type="checkbox"/>
■ Are storage areas out of sight or well screened from the street?	<input type="checkbox"/>	<input type="checkbox"/>
■ Are storage areas located at an appropriate distance from dwellings to reduce potential amenity impacts?	<input type="checkbox"/>	<input type="checkbox"/>
■ Are communal composting areas, if appropriate to the development, located with consideration for the potential amenity and environmental impacts?	<input type="checkbox"/>	<input type="checkbox"/>
<b>Waste collection points</b>		
■ Have collection points been identified that are <b>not</b> located:		
> near intersections?	<input type="checkbox"/>	<input type="checkbox"/>
> near roundabouts or slow-points?	<input type="checkbox"/>	<input type="checkbox"/>
> along busy arterial roads?	<input type="checkbox"/>	<input type="checkbox"/>
> in narrow lanes?	<input type="checkbox"/>	<input type="checkbox"/>
> near possible obstructions, including trees, overhanging buildings and overhead powerlines?	<input type="checkbox"/>	<input type="checkbox"/>
> where they pose a traffic hazard?	<input type="checkbox"/>	<input type="checkbox"/>
■ Is on-site servicing required? If so, has council been asked if it provides this service?	<input type="checkbox"/>	<input type="checkbox"/>
■ If there is agreement for on-site collection with the service provider, has an on-site collection point(s) been identified so that:		
> collection vehicles do not interfere with the use of access driveways, loading bays or parking bays during collections?	<input type="checkbox"/>	<input type="checkbox"/>
> the bin position(s) enables collection vehicles safe access to the collection point and has adequate clearance and manoeuvring space?	<input type="checkbox"/>	<input type="checkbox"/>
> there is clear vision of oncoming traffic as the collection vehicle leaves the property?	<input type="checkbox"/>	<input type="checkbox"/>
■ Are collection point(s) located on a level surface away from gradients and vehicle ramps?	<input type="checkbox"/>	<input type="checkbox"/>
■ If mobile garbage bins (MGBs) are to be used and collected from the kerb, is there sufficient space on an adjacent street for them to be lined up neatly in (preferably) a single row?	<input type="checkbox"/>	<input type="checkbox"/>
<b>Transfer of bins to the collection point</b>		
■ Is the bin transfer route free of steps?	<input type="checkbox"/>	<input type="checkbox"/>

# Appendix F

## Guide to Best Practice for Waste Management in Multi-unit Developments

Key issues	Completed	Not applicable
<ul style="list-style-type: none"> <li>■ If bins of 360L need to be wheeled to the collection point, are the following criteria met:</li> </ul>		
<ul style="list-style-type: none"> <li>› the distance does not exceed 75m in all circumstances</li> </ul>	<input type="checkbox"/>	<input type="checkbox"/>
<ul style="list-style-type: none"> <li>› the distance is limited to 50m if elderly persons will be moving bins</li> </ul>	<input type="checkbox"/>	<input type="checkbox"/>
<ul style="list-style-type: none"> <li>› the bin transfer grade does not exceed 1:14?</li> </ul>	<input type="checkbox"/>	<input type="checkbox"/>
<ul style="list-style-type: none"> <li>■ Are the following criteria met if bins or skips of greater than 360L capacity need to be wheeled from the intermediate storage point to the collection point:</li> </ul>		
<ul style="list-style-type: none"> <li>› if less than or equal to 1.0m<sup>3</sup> in capacity, does need to be wheeled more than 5m from the intermediate storage point to the collection point</li> </ul>	<input type="checkbox"/>	<input type="checkbox"/>
<ul style="list-style-type: none"> <li>› if greater than 1.5m<sup>3</sup> in capacity, manual manoeuvring of bins is avoided; or, if it cannot be avoided (for example if bins are stored in a room or enclosure), the bins do not need to be wheeled more than 3m from the intermediate storage point to the collection point</li> </ul>	<input type="checkbox"/>	<input type="checkbox"/>
<ul style="list-style-type: none"> <li>› the bin transfer grade does not exceed 1:30</li> </ul>	<input type="checkbox"/>	<input type="checkbox"/>
<b>Access for collection vehicles</b>		
<ul style="list-style-type: none"> <li>■ Does the design allow for the waste collection vehicle to move in a forward direction with no (or minimal) need to reverse?</li> </ul>	<input type="checkbox"/>	<input type="checkbox"/>
<ul style="list-style-type: none"> <li>■ Does the design accommodate access for heavy vehicles to collection points in accordance with relevant Acts, regulations, guidelines, and codes administered by Austroads, Vicroads, WorkSafe Victoria and any local traffic requirements?</li> </ul>	<input type="checkbox"/>	<input type="checkbox"/>
<b>Occupational health and safety</b>		
<ul style="list-style-type: none"> <li>■ Has there been a preliminary risk and hazard analysis to identify potential OH&amp;S risks associated with the proposed services and design layout?</li> </ul>	<input type="checkbox"/>	<input type="checkbox"/>
<ul style="list-style-type: none"> <li>■ Has the design been modified to eliminate or minimise the identified risks?</li> </ul>	<input type="checkbox"/>	<input type="checkbox"/>
<b>Noise</b>		
<ul style="list-style-type: none"> <li>■ Has the design considered best practice measures to minimise noise associated with use and servicing of the waste management facilities?</li> </ul>	<input type="checkbox"/>	<input type="checkbox"/>
<b>Odour</b>		
<ul style="list-style-type: none"> <li>■ Does the design incorporate ventilation for enclosed storage areas?</li> </ul>	<input type="checkbox"/>	<input type="checkbox"/>
<ul style="list-style-type: none"> <li>■ Does ventilation comply with the relevant codes and standards?</li> </ul>	<input type="checkbox"/>	<input type="checkbox"/>
<ul style="list-style-type: none"> <li>■ Are ventilation openings located as near the ceiling and floor as possible, but away from the windows of dwellings?</li> </ul>	<input type="checkbox"/>	<input type="checkbox"/>
<ul style="list-style-type: none"> <li>■ Are ventilation openings protected against flies and vermin?</li> </ul>	<input type="checkbox"/>	<input type="checkbox"/>

Key issues	Completed	Not applicable
<b>Hygiene</b>		
■ Have storage areas been designed to prevent the entry of vermin?	<input type="checkbox"/>	<input type="checkbox"/>
■ Are provisions for a tap and hose and correct drainage to sewer incorporated in communal bin storage areas?	<input type="checkbox"/>	<input type="checkbox"/>
<b>Amenity</b>		
■ Does the design of waste storage areas blend in with the development?	<input type="checkbox"/>	<input type="checkbox"/>
<b>Security</b>		
■ As far as possible, does the design allow easy access for residents but not non-residents to waste services?	<input type="checkbox"/>	<input type="checkbox"/>
■ Are bin areas sufficiently open and well lit to allow their use after dark?	<input type="checkbox"/>	<input type="checkbox"/>
■ Are all internal garbage and recycling rooms and storage areas fitted with fire sprinklers, and rated to fire safety according to the Building Code of Australia?	<input type="checkbox"/>	<input type="checkbox"/>
<b>Signage and education</b>		
■ Does the design specify the need for signs in public areas of the building identifying the location of garbage and recycling bins and storage areas?	<input type="checkbox"/>	<input type="checkbox"/>
■ Does the design specify the need for signs providing instructions on how to use the garbage and recycling facilities, including identifying what is and isn't recyclable?	<input type="checkbox"/>	<input type="checkbox"/>
■ Have requirements for safety signs been identified?	<input type="checkbox"/>	<input type="checkbox"/>
<b>Ongoing management</b>		
■ Is there a need to employ a building manager/caretaker and/or gardener:		
> to manage communal composting or worm farms?	<input type="checkbox"/>	<input type="checkbox"/>
> for transporting bins to the collection point?	<input type="checkbox"/>	<input type="checkbox"/>
■ Has an ongoing management plan been developed that identifies responsibilities for:		
> moving bins to and from the storage point to the collection point (if required) on collection day?	<input type="checkbox"/>	<input type="checkbox"/>
> washing bins and maintaining storage areas?	<input type="checkbox"/>	<input type="checkbox"/>
> arranging for the prompt removal of dumped rubbish?	<input type="checkbox"/>	<input type="checkbox"/>
> arrangements for consistent signs on all bins and in all communal storage areas?	<input type="checkbox"/>	<input type="checkbox"/>
> ensuring all residents are informed of the garbage and recycling arrangements?	<input type="checkbox"/>	<input type="checkbox"/>