



KNOX CITY COUNCIL

MINUTES

Ordinary Meeting of Council

Held at the

Civic Centre

511 Burwood Highway

Wantirna South

On

Tuesday 27 March 2018

KNOX CITY COUNCIL

**MINUTES FOR THE ORDINARY MEETING OF COUNCIL HELD AT THE
CIVIC CENTRE, 511 BURWOOD HIGHWAY, WANTIRNA SOUTH**

**ON
TUESDAY 27 MARCH 2018 AT 7.01 P.M.**

PRESENT:

<i>Cr J Mortimore (Mayor & Chairperson)</i>	<i>Chandler Ward</i>
<i>Cr J Keogh (Deputy Mayor)</i>	<i>Dobson Ward</i>
<i>Cr P Lockwood</i>	<i>Baird Ward</i>
<i>Cr J Taylor</i>	<i>Collier Ward</i>
<i>Cr A Gill</i>	<i>Dinsdale Ward</i>
<i>Cr T Holland (arrived at 7.38pm)</i>	<i>Friberg Ward</i>
<i>Cr L Cooper</i>	<i>Scott Ward</i>
<i>Cr D Pearce</i>	<i>Taylor Ward</i>
<i>Cr N Seymour</i>	<i>Tirhatuan Ward</i>
<i>Mr T Doyle</i>	<i>Chief Executive Officer</i>
<i>Dr I Bell</i>	<i>Director – Engineering & Infrastructure</i>
<i>Mr P Dickie</i>	<i>Acting Director - City Development</i>
<i>Mr D Monk</i>	<i>Acting Director – Corporate Development</i>
<i>Ms K Stubbings</i>	<i>Director – Community Services</i>
<i>Mr R McKail</i>	<i>Governance Advisor</i>

**THE MEETING OPENED WITH A PRAYER, STATEMENT OF ACKNOWLEDGEMENT
AND A STATEMENT OF COMMITMENT**

***“Knox City Council acknowledges we are on the
traditional land of the Wurundjeri and Bunurong people
and pay our respects to elders both past and present.”***

BUSINESS:**Page Nos.****1. APOLOGIES AND REQUESTS FOR LEAVE OF ABSENCE***Nil.***2. DECLARATIONS OF CONFLICT OF INTEREST***Nil.***3. CONFIRMATION OF MINUTES****COUNCIL RESOLUTION**MOVED: CR. PEARCESECONDED: CR. COOPER

3.1 Confirmation of Minutes of Ordinary Meeting of Council held on Monday 26 February 2018

CARRIED**COUNCIL RESOLUTION**MOVED: CR. PEARCESECONDED: CR. COOPER

3.2 Confirmation of Minutes of Strategic Planning Committee Meeting held on Tuesday 13 March 2018

CARRIED**4. PETITIONS AND MEMORIALS**

- 4.1 Councillor Pearce presented a petition with 11 signatories requesting support for the removal of the gumtrees planted in the nature strip of Robbie Close, Rowville.

The Petition lay on the table.

5. REPORTS BY COUNCILLORS

5.1 *Committees & Delegates*

1.

5.2 *Ward Issues*

4.

6. CONSIDERING AND ORDERING UPON OFFICERS' REPORTS WITHIN THE CITY DEVELOPMENT GROUP

- | | | |
|-----|---|-------------|
| | All Wards | |
| 6.1 | Report Of Planning Applications Decided Under Delegation | 7. |
| | Taylor Ward | |
| 6.2 | Application for the Development of the Land for Sixteen (16) Double Storey Dwellings and Four (4) Single Storey Dwellings (Total of 20 Dwellings) at 24-26 Taylors Lane, Rowville (Application No. P/2017/6315) | 12. |
| | All Wards | |
| 6.3 | Response to Call Up Item – Sunshine Coast Council Solar Farm and Opportunities for Knox | 63. |
| | Taylor and Tirhatuan Wards | |
| 6.4 | Construction of a Community Workshop and Horticultural Area at Rowville Recreation Reserve (Confidential) | 414. |

7. PUBLIC QUESTION TIME

(Following the completion of business relating to Item 6, City Development, the business before the Council Meeting will be deferred to consider questions submitted by the public). **118.**

8. CONSIDERING AND ORDERING UPON OFFICERS' REPORTS WITHIN THE ENGINEERING & INFRASTRUCTURE GROUP

- | | | |
|-----|---|-------------|
| | All Wards | |
| 8.1 | Alternative Buildings Progress Report and Tender Evaluation (Contract 2345) – Alternative Buildings Program | 120. |

9. CONSIDERING AND ORDERING UPON OFFICERS' REPORTS WITHIN THE COMMUNITY SERVICES GROUP

- | | | |
|-----|--|-------------|
| | All Wards | |
| 9.1 | Draft Knox Civic Art Collection Management Policy | 131. |
| | All Wards | |
| 9.2 | Knox Multicultural Advisory Committee Achievements 2012-2017 and Knox Multicultural Strategic Plan 2012-2017 Implementation Outcomes | 147. |

10. CONSIDERING AND ORDERING UPON OFFICERS' REPORTS WITHIN THE CORPORATE SERVICES GROUP

	All Wards	
10.1	2017-18 Annual Plan Progress Report to 31 December 2017	169.
	All Wards	
10.2	Minor Grants Program Applications	190.
	All Wards	
10.3	Revised Instruments of Delegation to Members of Council Staff	197.
	Dobson Ward	
10.4	Notice of Intention to Lease - 72 Francis Crescent, Ferntree Gully (Illoura House)	301.
	All Wards	
10.5	Appointment of Council and Independent Members to the Knox Council ICT Governance Committee (Confidential)	415.

11. ITEMS FOR INFORMATION

	All Wards	
11.1	Works Report (As at 2 March 2018)	307.
	All Wards	
11.2	Assemblies of Councillors	334.

12. MOTIONS FOR WHICH NOTICE HAS PREVIOUSLY BEEN GIVEN **347.**

12.1	Notice of Motion 76 – Amendment to the Electronic Gaming Policy	347.
------	---	-------------

13. SUPPLEMENTARY ITEMS **349.**

13.1	Draft Meeting Procedure and Use of Common Seal Local Law of 2018	349.
------	--	-------------

14. URGENT BUSINESS **411.**

14.1	Urgent Business	411.
14.2	Call Up Items	411.
14.2.1	Priority of Access to Knox Preschools	411.
14.2.2	Sports Demand Analysis	411.

15. QUESTIONS WITHOUT NOTICE

412.

TONY DOYLE
CHIEF EXECUTIVE OFFICER

Official Minutes of Knox City Council

5. REPORTS BY COUNCILLORS

5.1 Committees & Delegates

5.1.1 COUNCILLOR LISA COOPER

Councillor Cooper attended the following Meetings

- Hotshots Knox Gardens
- Melbourne Boomers x 2
- Planning Consultative Committee
- Councillor Leadership Weekend

5.1.2 COUNCILLOR JAKE KEOGH

Councillor Keogh attended the following Meetings

- Knox Interfaith Network Meeting
- Knox Multicultural Advisory Committee
- Equiknox Annual General Meeting
- Audit Committee Meeting
- Eastern Regional Group of Mayors, Councillor Representatives and CEOs
- Knox Festival x 2
- Knox Factor Judging
- MC Knox Festival Youth Stage
- Illoura Annual General Meeting
- Knox Sport and Leisure Awards Evaluation Committee
- Committee of Council - Lease of Council Property
- Hon John Eren, Minister for Sport
- "Bike It" Challenge
- Melbourne Boomers
- Ferntree Gully and Lysterfield Football Club
- Youth Advisory Committee
- Rating Strategy Overview
- World Water Day Event
- Citizenship Ceremony
- Councillor Leadership Weekend

5.1.3 COUNCILLOR NICOLE SEYMOUR

Councillor Seymour attended the following Meetings

- Knox Active Ageing Advisory Committee x 2
- Knox Festival
- Councillor Leadership Weekend

5.1 Committees & Delegates (cont'd)

5.1.4 COUNCILLOR JACKSON TAYLOR

Councillor Taylor attended the following Meetings

- Youth Advisory Committee
- Flamingo Reserve
- Finance Training
- Knox Elderly Citizens Club Year of the Dog Chinese New Year
- Knox Factor Judging
- Bayswater Seniors
- Templeton Tennis Club
- Wantirna Secondary College
- Knox Sport and Leisure Awards
- T20 Cricket Match with Council staff
- Melbourne Boomers
- Templeton Orchards Pre School
- Rating Strategy Overview
- World Water Day Event
- 5 Year Celebration Breakfast – Enhancing Our Dandenong Creek
- Councillor Leadership Weekend

5.1.5 COUNCILLOR DARREN PEARCE

Councillor Pearce attended the following Meetings

- Audit Committee Meeting
- Knox Festival x 2
- Melbourne Boomers
- Official Opening – Waterman Business Centre
- Committee of Council - Lease of Council Property
- Rowville Eagles Football Club
- Faith Speed Dating Event
- Planning Consultative Committee
- Councillor Leadership Weekend

5.1 Committees & Delegates (cont'd)

5.1.6 COUNCILLOR JOHN MORTIMORE

Councillor Mortimore attended the following Meetings

- Social Housing Investment Planning Meeting
- Eastern Regional Group Meeting
- Minister Tudge re Citizenship Ceremonies
- Knox Festival
- The Basin Hindu Temple – Shivali
- Modular Construction and Pre-Fabrication Conference
- Mayoral Interview with Eastern FM Radio
- Official Opening – Waterman Business Centre
- CEO Staff Briefing
- Boronia Renewal Project Meeting
- Knox Affordable Housing Advisory Committee
- Committee of Council - Lease of Council Property
- Hon John Eren, Minister for Sport
- Minister Marlene Kairouz, Minister for Consumer Affairs, Gaming and Liquor Regulation and Minister for Local Government
- “Bike It” Challenge
- Melbourne Boomers
- Knox Schools Expo
- Faith Speed Dating
- Official Opening of the Knox 44th Annual Art Show and Presentation of Prizes
- Knox Art Show
- Crime Victims Support Association
- Rating Strategy Overview
- Knox Active Ageing Advisory Committee
- 5 Year Celebration Breakfast – Enhancing Our Dandenong Creek
- Community Garden Site Visit
- Citizenship Ceremony
- Councillor Leadership Weekend

5.2 Ward Issues

5.2.1 COUNCILLOR DARREN PEARCE (TAYLOR WARD)

- Councillor Pearce advised that VCAT had upheld Council's decision to refuse a planning application for villa units in Murray Crescent, Rowville. Councillor Pearce explained that Council originally refused the application as it did not meet the strategic intent of Knox's housing policy and not appropriate for a residential street. Councillor Pearce noted it is pleasing that VCAT has upheld the spirit and intent of the strategic housing strategy.

5.2.2 COUNCILLOR NICOLE SEYMOUR (TIRHATUAN WARD)

- Councillor Seymour discussed the positive use of social media by people within the municipality to find lost pets, misplaced bikes and guide the community on anti-social behaviour. Councillor Seymour stated she was especially proud of her ward and their recent use of social media to locate a Scoresby resident, with Alzheimer's, who went missing and was subsequently found waist deep in Dandenong Creek. Councillor Seymour appreciates the power of the 'modern bush telegraph' as the resident is alive today due to it.
- Councillor Seymour spoke about the release of the RACV report on the top 140 Public Transport priorities for Victoria. Councillor Seymour stated it was no surprise that constructing the Rowville Rail had been voted the top priority. The rail line would ease traffic congestion and its current lack denies young people with the ability to reach facilities, such as Monash University, as equitably as others. Councillor Seymour added this report will be a great platform for the Eastern Transport Coalition to increase their advocacy for the Rowville Rail to be built and soon.

5.2.3 COUNCILLOR PETER LOCKWOOD (BAIRD WARD)

- Councillor Lockwood discussed a recent petition for a footpath on London Drive Bayswater. Councillor Lockwood advised that he has recently conducted a site visit and believes there is more to the petition than meets the eye as there are currently obstructions on the nature strip that force people to walk on the road.
- Councillor Lockwood advised that the Eastern Transport Coalition (ETC) are undertaking advocacy on 50 projects including the Rowville Rail. A new campaign starts next week with questionnaires being given to commuters on the Belgrave / Lilydale line. The ETC are planning to make "a bit of noise" about transport priorities. Councillor Lockwood concluded that this campaign started last year and will be continuing into the future.

5.2 Ward Issues (cont'd)

5.2.1 COUNCILLOR JAKE KEOGH (DOBSON WARD)

- Councillor Keogh acknowledged the great success of the recent Knox Festival and noted that this year's festival had record attendance numbers. Councillor Keogh congratulated the winners of the Knox Factor and passed on his appreciation to the Council officers who organised the event.
- Councillor Keogh advised that he has recent met with two sporting clubs in his ward and discussed their need for increased facilities. Each of the clubs have 23 teams and don't have adequate facilities for training. Councillor Keogh noted this is an issue in the Southern part of the municipality and needs to be given attention in the next few years.

5.2.5 COUNCILLOR ADAM GILL (DINSDALE WARD)

- Councillor Gill advised that he recently met with the Minister for Roads to discuss a possible land swap for land on the corner of Station St and Mountain Highway. Councillor Gill advised that work is currently being done on this matter and further information can be expected in the coming weeks.

5.2.6 COUNCILLOR JOHN MORTIMORE (CHANDLER WARD)

- Councillor Mortimore welcomed members from the Upwey Foresters to the Gallery and noted it was always a pleasure to have members of Scouts in the Council Chamber.
- Councillor Mortimore was pleased to advise that The Basin Music Festival was once again a successful event and thanked Council officers for their assistance with this event.
- Councillor Mortimore informed Council that 500 metres of footpath on Mountain Highway. The Basin is currently being installed.
- Councillor Mortimore advised the Boronia Renewal Project is proceeding well. Councillor Mortimore noted that Community Consultation is being undertaken with support from Council Officers

PROCEDURAL MOTION**MOVED: CR. PEARCE****SECONDED: CR. KEOGH**

That the following agenda items be moved and considered after Item 15 Questions Without Notice:

- **Item 6.4 - Construction of a Community Workshop and Horticultural Area at Rowville Recreation Reserve; and**
- **Item 10.5 - Appointment of Council and Independent Members to the Knox Council ICT Governance Committee following the conclusion of item 15.**

CARRIED

Official Minutes of Knox City Council

ALL WARDS**6.1 REPORT OF PLANNING APPLICATIONS DECIDED UNDER DELEGATION**

SUMMARY: *Acting Manager – City Planning & Building (Greg Kent)*

Details of planning applications considered under delegation are referred for information. It is recommended that the items be noted.

RECOMMENDATION

That the planning applications decided under delegation report (between 1 February to 28 February 2018) be noted.

REPORT

Details of planning applications decided under delegation from 1 February to 28 February 2018 are attached. The applications are summarised as follows:

Application Type	No
Building & Works: Residential	3
Other	2
Units	22
Subdivision	14
Tree Removal/Pruning	9
Change of Use	5
Car Parking	2
Single Dwelling	1
Removal of Covenant	1
TOTAL	59

COUNCIL RESOLUTION

MOVED: CR. PEARCE

SECONDED: CR. TAYLOR

That the planning applications decided under delegation report (between 1 February to 28 February 2018) be noted.

CARRIED

Knox City Council
Planning Applications Decided by Responsible Officer

1 February 2018 – 28 February 2018

Ward	No/Type	Address	Description	Decision
Baird	2018/6021	44 McMahons Road FERNTREE GULLY VIC 3156	3 lot subdivision (Approved Unit Site)	16/02/2018 Approved
Baird	2017/6711	2/15 Newcastle Road BAYSWATER VIC 3153	Change of use (Recording Studio)	6/02/2018 Approved
Baird	2017/6552	337 Scoresby Road FERNTREE GULLY VIC 3156	Construction of a double storey dwelling to the rear of existing dwelling, alteration of access to a Road Zone and two lot subdivision	8/02/2018 Approved
Baird	2017/6523	24 Devenish Road BORONIA VIC 3155	The construction of two (2) double storey dwellings and one (1) single storey dwelling, and the removal and pruning of vegetation	7/02/2018 Approved
Baird	2017/6609	14 Park Crescent BORONIA VIC 3155	Development of land for three (3) double storey dwellings	5/02/2018 Approved
Baird	2017/6579	15 & 17 Duncan Avenue BORONIA VIC 3155	Six lot subdivision (Approved Unit Site)	23/02/2018 Approved
Baird	2018/9018	245 Scoresby Road BORONIA VIC 3155	2 lot subdivision	12/02/2018 Approved
Baird	2017/6486	8 Laurel Avenue BORONIA VIC 3155	Development of the land for seven (7) double storey dwellings	6/02/2018 Approved
Baird	2017/6627	12 Sykes Avenue FERNTREE GULLY VIC 3156	Development of the land for two single storey dwellings	16/02/2018 Approved
Baird	2017/6546	42 Burke Road FERNTREE GULLY VIC 3156	The construction of two (2) double storey dwellings and two (2) single storey dwellings (total 4 dwellings)	15/02/2018 Notice of Decision
Baird	2017/6402	29 Warbler Court BORONIA VIC 3155	Development of the land for three (3) double storey dwellings and three (3) lot subdivision	21/02/2018 Notice of Decision
Chandler	2017/6525	22 Elsie Street BORONIA VIC 3155	The construction of six (6) double storey dwellings and vegetation removal	14/02/2018 Refused
Chandler	2018/9020	8B Bellevue Court BORONIA VIC 3155	Removal of one Eucalyptus polyanthemos (Red Box) tree	16/02/2018 Approved
Chandler	2018/9015	28 Hansen Road BORONIA VIC 3155	Remove one Eucalyptus tree	8/02/2018 Approved
Chandler	2018/9016	25 Royalden Close BORONIA VIC 3155	Remove one Photinia robusta tree	8/02/2018 Approved

Ward	No/Type	Address	Description	Decision
Chandler	2018/6046	174 Albert Avenue BORONIA VIC 3155	Removal of two (2) Eucalyptus obliqua trees	8/02/2018 Approved
Chandler	2017/6536	216 Basin-Olinda Road SASSAFRAS VIC 3787	Buildings and works for a shed	5/02/2018 Approved
Chandler	2018/6068	39 Stewart Street BORONIA VIC 3155	Remove one Eucalyptus goniocalyx and one Eucalyptus obliqua	21/02/2018 Approved
Chandler	2017/6510	21 Augusta Road THE BASIN VIC 3154	Two lot subdivision, construction works for the subdivision and removal of vegetation	16/02/2018 Approved
Chandler	2017/6384	476 Dorset Road BORONIA VIC 3155	The construction of three (3) double storey dwellings and one (1) single storey dwelling and alteration of access to a Road Zone Category 1	15/02/2018 Notice of Decision
Chandler	2017/6434	72 Boronia Road BORONIA VIC 3155	Removal of Covenant 2300922	15/02/2018 Refused
Chandler	2018/6015	1 & 2 /37 Timewell Crescent BORONIA VIC 3155	Two lot re-subdivision strata plan and dissolution of Owners' Corporation	12/02/2018 Approved
Chandler	2017/6671	12 Augusta Road THE BASIN VIC 3154	Two (2) lot subdivision and removal of vegetation	16/02/2018 Approved
Collier	2017/6439	14 Dayan Drive WANTIRNA SOUTH VIC 3152	Development of land for two double storey dwellings	15/02/2018 Notice of Decision
Dinsdale	2017/6590	16 View Road BAYSWATER VIC 3153	Development of the land for six (6) three storey dwellings	7/02/2018 Notice of Decision
Dinsdale	2017/6409	20 Parkhurst Drive KNOXFIELD VIC 3180	Change of Use (Animal (Dogs) Boarding and dog grooming), Buildings and Works and Business Identification Signage	6/02/2018 Notice of Decision
Dinsdale	2018/9021	13/655 Mountain Highway BAYSWATER VIC 3153	Carparking dispensation associated with a medical clinic	22/02/2018 Approved
Dinsdale	2018/9026	3/25 Elm Street BAYSWATER VIC 3153	Removal of one Eucalyptus obliqua tree	23/02/2018 Approved
Dinsdale	2018/9023	10 Coleman Road WANTIRNA SOUTH VIC 3152	2 lot subdivision	21/02/2018 Approved
Dinsdale	2017/6186	53 Pentlowe Road WANTIRNA SOUTH VIC 3152	2 Lot subdivision (Approved Unit Site)	14/02/2018 Approved
Dinsdale	2018/9029	2 Princess Street BAYSWATER VIC 3153	2 lot subdivision	26/02/2018 Approved

Ward	No/Type	Address	Description	Decision
Dinsdale	2017/6303	305 Boronia Road BORONIA VIC 3155	The construction of six (6) double storey dwellings and two (2) single storey dwelling and reduction in car parking requirement and access to RDZ1.	16/02/2018 Approved
Dinsdale	2017/6692	81 Lewis Road WANTIRNA SOUTH VIC 3152	Change of Use (Indoor recreation facility swim school)	15/02/2018 Approved
Dinsdale	2016/6926	614 Mountain Highway BAYSWATER VIC 3153	Alteration and additions to existing commercial building, display of internally-illuminated advertising signs, and reduction in car parking requirements	23/02/2018 Refused
Dobson	2018/6032	15 Blackwood Park Road FERNTREE GULLY VIC 3156	2 lot subdivision (Approved Unit Site)	6/02/2018 Approved
Dobson	2017/6347	2 Mayfair Drive FERNTREE GULLY VIC 3156	2 Lot subdivision (Approved Unit Site)	8/02/2018 Approved
Dobson	2017/6801	7 Anderson Street FERNTREE GULLY VIC 3156	Buildings and works (enclosure of the lower level below the existing floor level)	2/02/2018 Approved
Dobson	2018/9022	6 Williamson Road FERNTREE GULLY VIC 3156	Remove one Eucalyptus melliodora tree	21/02/2018 Approved
Dobson	2017/6777	65 Mountain Gate Drive FERNTREE GULLY VIC 3156	Development of two (2) single storey dwellings and Two (2) lot subdivision	21/02/2018 Approved
Dobson	2018/6079	34 Frederick Street FERNTREE GULLY VIC 3156	Removal of 5 trees and the pruning of one tree	23/02/2018 Approved
Dobson	2018/9030	31 Hunter Street FERNTREE GULLY VIC 3156	Removal of one Eucalyptus macrorhyncha	28/02/2018 Approved
Dobson	2017/6822	9 Logan Court LYSTERFIELD VIC 3156	Use and development of a dwelling	15/02/2018 Approved
Dobson	2017/6263	130 Glenfern Road FERNTREE GULLY VIC 3156	Development of the land for two (2) dwellings to the side of the existing dwelling, Vegetation Removal and creation access to a Road Zone Category 1	26/02/2018 Notice of Decision
Friberg	2017/6793	36 Laura Road KNOXFIELD VIC 3180	2 lot subdivision (Approved Unit Site)	9/02/2018 Approved
Friberg	2018/9019	34 Elton Road FERNTREE GULLY VIC 3156	2 lot subdivision (Approved Unit Site)	12/02/2018 Approved

Ward	No/Type	Address	Description	Decision
Friberg	2017/6474	29 Harwell Road FERNTREE GULLY VIC 3156	The construction of a double storey dwelling to the rear of the existing dwelling	16/02/2018 Approved
Scott	2017/6567	12 Tyner Road WANTIRNA SOUTH VIC 3152	Development of the land for four (4) three storey dwellings	15/02/2018 Notice of Decision
Scott	2018/6083	7 Justin Court WANTIRNA SOUTH VIC 3152	2 lot subdivision (Existing Dwellings)	23/02/2018 Approved
Taylor	2017/6411	6 Fordham Court ROWVILLE VIC 3178	Development of the land for four (4) double storey and two (2) single storey dwellings (Total six dwellings)	15/02/2018 Notice of Decision
Taylor	2017/6759	16 Cornish Road LYSTERFIELD VIC 3156	Buildings and Works (Carport extension to existing shed)	6/02/2018 Approved
Taylor	2017/6696	13 Celestial Court ROWVILLE VIC 3178	Development of the land for a double storey dwelling to the rear of the existing dwelling	16/02/2018 Notice of Decision
Tirhatuan	2017/6652	760 Stud Road SCORESBY VIC 3179	Reduction of car parking associated with a medical centre	8/02/2018 Approved
Tirhatuan	2017/6634	88/1470 Ferntree Gully Road KNOXFIELD VIC 3180	Change of Use to Restricted Recreation Facility (Fitness Studio)	21/02/2018 Approved
Tirhatuan	2017/6554	723 Stud Road SCORESBY VIC 3179	The development of the land for three (3) double storey dwellings and access to a Road Zone Category 1	7/02/2018 Approved
Tirhatuan	2017/6394	11 Corporate Avenue ROWVILLE VIC 3178	Use of the land for the purpose of a Food and Drink Premise (Restaurant), Place of Assembly (Function Centre) and Sale and Consumption of Liquor	21/02/2018 Approved
Tirhatuan	2017/6710	25 Rosehill Street SCORESBY VIC 3179	Development of the land for a double storey dwelling to the rear of the existing dwelling	15/02/2018 Notice of Decision
Tirhatuan	2017/6606	22 Roma Street SCORESBY VIC 3179	Development of the land for a double storey dwelling to the rear of the existing dwelling	15/02/2018 Approved
Tirhatuan	2017/6453	8 Elizabeth Court ROWVILLE VIC 3178	The construction of three (3) double storey dwellings and one (1) single storey dwelling on the land	15/02/2018 Approved
Tirhatuan	2018/9027	17/1470 Ferntree Gully Road KNOXFIELD VIC 3180	Buildings and works associated with a mezzanine floor	27/02/2018 Approved

Total: 59

TAYLOR WARD

6.2 APPLICATION FOR THE DEVELOPMENT OF THE LAND FOR SIXTEEN (16) DOUBLE STOREY DWELLINGS AND FOUR (4) SINGLE STOREY DWELLINGS (TOTAL OF 20 DWELLINGS) AT 24-26 TAYLORS LANE, ROWVILLE, (APPLICATION NO. P/2017/6315)

1. SUMMARY:

Land:	24-26 Taylors Lane, Rowville
Applicant:	Clarke Planning
Proposed Development:	The development of the land for sixteen (16) double storey dwellings and four (4) single storey dwellings (total of 20 dwellings)
Existing Land Use:	Single dwelling
Area:	6,330m ²
Zoning:	General Residential 2 Zone
Overlays:	Nil
Local Policy:	Municipal Strategic Statement (MSS) Development in Residential Areas and Neighbourhood Character Policy Environmentally Sustainable Development Policy
Application Received:	23 May 2017
Number of Objections:	45
PCC Meeting:	N/A

Assessment:

The original proposal was refused by Council under delegation on 13 October 2017. The applicant appealed Council's decision, and a Compulsory Conference was heard at VCAT on 19 February 2018 and 2 March 2018. At the conference, the applicant presented amended plans which addressed many of the concerns raised by Council. It was agreed that a Planning Permit could be issued, subject to Council's approval.

It is considered that subject to the changes as submitted at the VCAT compulsory conference, the proposal to develop the land for 20 dwellings (sixteen (16) double storey and (four) 4 single storey) provides an appropriate balance between the need for additional housing within a fully serviced area and the amenity of occupants and adjoining residents.

The proposal now generally complies with the Municipal Strategic Statement (MSS), the Development in Residential Areas and Neighbourhood Character Policy, the Housing Policy, and ResCode.

6.2 24-26 Taylors Lane, Rowville (cont'd)

The proposal now complies with the General Residential 2 Zone.

On balance it is considered that the revised proposal responds well to State and Local Planning Policies, subject to modifications. It is recommended that Council adopt the agreement reached between the parties present at the VCAT compulsory conference that a planning permit be issued, subject to conditions.

2. BACKGROUND

2.1 Subject Site and Surrounds

The location of the subject site is shown in Appendix A.

- The site is located on the east side of Taylors Lane, Rowville. The site is rectangular in shape with a frontage of 74m and a depth of 84m, forming a site area approximately 6,330m².
- Part of the rear boundary contains a 2m wide easement. The site has a fall of approximately 1m to the rear (east).
- The site contains a single dwelling with associated outbuildings. Vehicle access to the site is via an existing single crossover.
- No significant vegetation exists on site.

2.2 The Proposal (Assessed by Council Officers – 13 October 2017)

(Refer to attached plans at Appendix B)

- The existing dwelling and outbuildings will be removed (planning permit not required for demolition).
- The construction of 22 double storey dwellings comprising: 2 x 2-bedroom dwellings, 6 x 3-bedroom dwellings and 14 x 4-bedroom dwellings.
- All dwellings containing 3 or 4 bedrooms are provided with a garage containing two car spaces (either in the form of a double garage or a tandem garage). The dwellings containing 2 bedrooms are provided with a single garage.
- The provision of 4 visitor car parking spaces.
- The existing crossover will be removed with 4 crossovers proposed to provide vehicle access to the development. A crossover adjacent the north boundary will service Dwelling 1 and the crossover adjacent the south boundary will service Dwelling 22. The remaining crossovers will service Dwellings 2-11 and 12-21, respectively.
- The proposed materials include: brick, render, timber look cladding and concrete roof tiles.

6.2 24-26 Taylors Lane, Rowville (cont'd)

- The development will not exceed 7.9m in height.
- All vegetation will be removed from the site to facilitate the development.

2.3 Assessment of the Application

On 13 October 2017, the application was refused by Council, for the following reasons:

1. The built form of the proposed development, particularly the double storey built form of Dwellings 5, 6, 17 and 18 is inconsistent with the requirements of Clause 15.01-2 (Urban environment), Clause 21.04 (Urban Design) and Clause 22.07 (Neighbourhood Character) of the Knox Planning Scheme as the proposal fails to achieve architectural and urban design outcomes that contribute positively to the preferred neighbourhood character and does not respond positively to the characteristics of the surrounding area.
2. The proposal is inconsistent with Clause 21.05 (Housing) and Clause 22.07 (Development in Residential Areas and Neighbourhood Character: Knox Neighbourhood) given accumulative effect of upper floor bulk and double storey built form at the rear of the site.
3. The proposal is inconsistent with Clause 21.05 (Housing) and Clause 22.07 (Development in Residential Areas and Neighbourhood Character: Knox Neighbourhood) as it does not reflect the preferred landscape character of the area.
4. The development fails to comply with the Private Open Space requirements of the General Residential Zone, Schedule 2 of the Knox Planning Scheme.
5. The proposed development will have an unreasonable impact on the backyard amenity and character of the surrounding sites due to the visual bulk to the abutting properties.
6. The proposal will have a negative impact on vegetation on adjoining land.
7. The proposal does not optimise areas set aside for landscaping, particularly along the common access way and the rear (east) boundary to integrate the development into the area and maintain the landscape character of the area.
8. The proposal does not satisfy Design Standard 7 of Clause 52.06 (Car Parking) of the Knox Planning Scheme.
9. The proposal represents an overdevelopment of the site. The design fails to respond appropriately to its opportunities and constraints resulting in an unreasonable impact on the character of the area and will result in poor internal amenity for future residents.

6.2 24-26 Taylors Lane, Rowville (cont'd)

10. The proposal fails to satisfy the relevant Clause 55 objectives and standards, in particular:

- 55.02-1 Neighbourhood Character
- 55.02-2 Residential policy
- 55.02-3 Dwelling diversity
- 55.03-1 Street Setback
- 55.03-8 Landscaping
- 55.04-6 Overlooking
- 55.05-4 Private Open Space
- 55.05-5 Solar Access
- 55.05-6 Storage

and therefore represents an overdevelopment of the site. The design fails to respond appropriately to its opportunities and constraints resulting in unreasonable impact on the character of the area.

Following on from Council's decision, the applicant lodged an appeal with VCAT against Council's refusal. One (1) objector to the application also registered to be a party to the hearing.

2.4 VCAT – Compulsory Conference

On 19 February 2018, a compulsory conference was held at VCAT. This is standard VCAT process for all major cases. The purpose of the conference was to allow the parties to the hearing to hear each other's issues/opinions with the proposal, and to see whether there was any room for a negotiated outcome. Parties to the conference were Council and the applicant. The objector did not attend and therefore was struck out as a party.

The applicant provided a set of amended plans which aimed to address Council's concerns.

(Refer to attached plans at Appendix C)

The main changes to the ground floor plans were:

- Reduction in the yield of dwellings from 22 dwellings to 20 dwellings. This is achieved by removing a dwelling from the central rows.
- The dwellings at the end of the 4 rows are now single storey with a 3m setback from the rear boundary line.
- Introduce setbacks from trees on abutting lots to ensure no encroachment into the structural root zone (SRZ) and below the specified 10% encroachment into the tree protection zone (TPZ) to minimise impact on neighbouring vegetation.

6.2 24-26 Taylors Lane, Rowville (cont'd)

- Dwelling 20 garage repositioned to enter from the common driveway. Therefore the number of crossovers to Taylors Lane has been reduced from four to three.
- Dwelling 11 front setback increased from 7m to 8m.
- Dwelling 20 front setback increased from 8m to 9m.
- Extent of landscaping along the common driveways increased.
- Deletion of internal gates.
- Site setbacks to all boundaries varied and generally increased.

The main changes to the first floor plans were:

- Dwelling 1 and 2 north facing windows modified in terms of setback, sill height or orientation.
- Amount of first floor elements on the two central rows reduced from 6 components down to 4.
- Southern row elements fragmented into separate forms, each no more than 10m in length, as opposed to being 'co-joined' with each other.

Conditions were drafted to be included in any permit issued, and are located in the recommendation section of this report.

At the subsequent Compulsory Conference on 2 March 2018, the parties signed the conditions, as part as an agreement at the conference.

The agreement includes the following statement:

If the Responsible Authority consents and no new parties arise from notice of amended plans, this agreement stands.

If the Responsible Authority does not consent, this agreement is void and the matter will proceed to hearing on 19 April 2018.

If the Responsible Authority consents but new parties arise from notice of amended plans, the matter be set down for further compulsory conference at 9:30am on 5 April 2018.

Therefore, this application is being reported to Council. The remainder of this report will assess the amended proposal as agreed by the parties to the VCAT conference.

6.2 24-26 Taylors Lane, Rowville (cont'd)

If Council does not support the amended plans and proposed conditions as agreed by parties at the VCAT compulsory conference, then the matter will revert back to a merits appeal on the original proposal (unless the applicant amends the application at a later date).

3. CONSULTATION

3.1 Advertising

The application was advertised by way of signs on the site and notices were sent to adjoining property owners and occupiers. 45 objections were received and are summarised below.

Car Parking & Traffic

- *Car parking has been provided at ratios consistent with Clause 52.06 (Car Parking) of the Knox Planning Scheme. The proposed development is not expected to cause an unreasonable increase in traffic flows within the local street network.*

Waste management

- *The application was referred to Council's Waste Management Department who did not object to the proposed development. A condition of any permit to issue will require the submission of an amended Waste Management Plan (WMP) to the satisfaction of the Responsible Authority.*

Overdevelopment

- *The amended design response is not considered to be an overdevelopment of the site with the dwellings generally complying with ResCode Standards (Clause 55), in particular site coverage, landscaping, overlooking and overshadowing. Private open space areas and car parking have been provided at ratios consistent with the Knox Planning Scheme. Further, the amended proposal is considered to achieve the neighbourhood character design objectives of the Knox Neighbourhood Area in terms of providing single storey dwellings and reducing the upper floor levels of the double storey dwellings, reducing building mass and bulk.*

Neighbourhood Character

- *An assessment of the proposed development against Clause 22.07 Neighbourhood Character Policy is provided below.*

Amenity impacts (including noise)

- *The site is located within an established residential area where associated noise is a common feature of urban areas. The development will not result in an unreasonable increase in residential noise. Standard construction amenity conditions will be placed on any permit issued.*

6.2 24-26 Taylors Lane, Rowville (cont'd)

Impact on property values

- *This is not a valid planning concern.*

Non-compliances with ResCode (i.e. infrastructure, site coverage/permeability, overshadowing, overlooking, private open space, solar access)

- *An assessment of the proposed development against Clause 55 (ResCode) is provided below.*

As outlined above, one (1) objector was a party to the VCAT process, however as they did not attend the Compulsory Conference, they have been struck out and are therefore no longer a party to the VCAT proceedings.

3.2 Referrals

The application was referred to internal departments for advice. The following is a summary of relevant advice:

Traffic Engineer

- *Standard conditions to be included on any permit issued.*

Stormwater

- *Inadequate overland flow path through the property is shown. The applicant must demonstrate how overland flow for the 100 year ARI will be appropriately managed to Council's satisfaction. This can be addressed via conditions of any permit to issue.*

Landscape

- *Standard conditions to be included on any permit issued.*

Parks Services

- *A *Corymbia ficifolia* will require removal for the construction of a crossover. The tree can be removed upon receipt of \$ 4,808.34. Total cost for street tree removal includes; amenity value, cost of tree and stump removal and planting and maintaining a new tree for 2 years.*

Arborist

- *The amended plans have ensured that vegetation located on adjoining properties will not be impacted. This addresses the initial concerns with reference to the impact of the proposal on adjoining vegetation.*

ESD Officer

- *The Sustainable Design Assessment (SDA) submitted with the application is satisfactory.*

6.2 24-26 Taylors Lane, Rowville (cont'd)

Building

- *No objection.*

Waste

- *Further detail regarding the frequency of hard waste collections is required.*
- *A condition of any permit to issue will require the submission of an amended WMP to the satisfaction of the Responsible Authority.*

Assets

- *All crossovers must match the internal width of the access way.*

4. DISCUSSION

This section considers the proposed development in light of the provisions of the Knox Planning Scheme including State and Local Planning Policies, any other relevant policies and objectives.

4.1 Zoning and Overlays

4.1.1 Zone

The site is located within the General Residential Zone – Schedule 2. A permit is required for the construction two or more dwellings on a lot.

- *The proposal is consistent with the purpose of the General Residential Zone by providing for diversity in housing types that respects the neighbourhood character of the area.*

Schedule 2 to the General Residential Zone varies the ResCode requirements for Standard B13 (Landscaping) which requires a minimum of one canopy tree per 175 square metres of the site area including a minimum of one canopy tree within each area of secluded private open space and one canopy tree within the front setback per 5 metres of width of the site. Each tree should be required to be surrounded by 20 square metres of permeable surface with a minimum radius of 3 metres. Up to 50 per cent of the permeable surface may be shared with another tree.

- *It is considered that the amended plans can accommodate the required canopy tree planting.*

6.2 24-26 Taylors Lane, Rowville (cont'd)

Schedule 2 to the General Residential Zone also varies the ResCode requirements for Standard B28 (Private Open Space) which requires the provision of private open space consisting of a minimum area of 80 square metres including one part of secluded private open space at the side or rear of the dwelling with a minimum area of 60 square metres with a minimum dimension of 5 metres with convenient access from a living room.

- *Complies. All dwellings are provided with 80m² of private open space, including 60m² of secluded private open space with a minimum dimension of 5m.*

Schedule 2 to the General Residential Zone also varies the ResCode requirements for Standard B32 (Front fence height) which requires a front fence height of 2m to a street in a Road Zone Category 1 and 1.2m to other streets.

- *No front fence is proposed.*

Dwellings or residential buildings must not exceed a height of 9 metres (dependant on slope).

- *Complies. The development will not exceed 9m in height.*

4.1.2 Overlays

The site is not affected by any overlays.

4.2 Policy Consideration

4.2.1 State Planning Policy Framework (SPPF)

State policy requires Council to integrate the range of policies relevant to the issues to be determined, and balance conflicting objectives in favour of net community benefit and sustainable development.

Clause 15 Built Environment and Heritage – Encourages high quality architecture and urban design outcomes that reflects the particular characteristics, aspirations and cultural identity of the community; enhances liveability, diversity, amenity and safety of the public realm; and promotes attractiveness of towns and cities within broader strategic contexts.

- *The design of the development will make a positive contribution to the surrounding area, with built form considered to be appropriate in form and scale. The development incorporates important neighbourhood character features such as pitched roofs, brick finishes, eaves and car parking located behind or alongside the proposed dwellings. The upper levels of the dwellings have been reduced in size and the development now incorporates single storey dwellings to the rear, reducing building bulk and mass to the adjoining residential properties.*

6.2 24-26 Taylors Lane, Rowville (cont'd)

Clause 15.02 Sustainable Development – Ensure that land use and development is consistent with the efficient use of energy and the minimisation of greenhouse gas emissions.

- *A satisfactory Sustainable Design Assessment has been provided with the application.*

Clause 16 Housing – Encourage the development of well-designed medium-density housing that respects the neighbourhood character; improves housing choice; makes better use of existing infrastructure; and, improves energy efficiency of housing. Locate new housing in or close to activity centres and employment corridors and at other strategic development sites that offer good access to services and transport.

- *Neighbourhood character - This is discussed in a later section of the report (Section 4.2.2).*
- *Housing choice – The development provides a mix of double storey and single storey dwellings, providing a range of housing choices.*
- *Existing infrastructure – The site is located within a fully serviced area.*
- *Energy efficiency – This has been discussed above under Clause 15.02.*
- *Location – While the site is not located within an Activity Centre, it has access to a number of urban services within an established area. The subject site is capable of accommodating the proposed dwellings whilst making a positive contribution to the character of the area. Refer to the assessment against Council's Neighbourhood Character Policy at Section 4.2.2 below.*

Clause 18 Transport – Ensure that access is provided to all available modes of transport.

- *Bus route 697 operates along Wellington Road. The 697 service provides transport to the Dandenong Market on Tuesdays only between the hours of 9.45am and 10.30am, with the return bus available between the hours of 1.15pm and 2.00pm.*
- *Bus routes 681/682 are available along Taylors Lane. The 681/682 service runs at various intervals between Lysterfield and Rowville from 6.10am to 9.25pm weekdays, from 8.14am to 7.05pm Saturdays, and 9.14am to 6.01pm on Sundays.*

6.2 24-26 Taylors Lane, Rowville (cont'd)

4.2.2 Local Planning Policy Framework

Municipal Strategic Statement (MSS)

Council's MSS encourages development occurring with the necessary consideration to such matters as managing population growth, encouraging sustainable development, and influencing the urban form so that Knox itself becomes more sustainable.

With specific reference to the aging population in Knox, the MSS contains the following statement:

“The Knox community is diversifying and ageing. Knox's dominant household type remains families with children, with the number of children (and their parents) forecast to increase over the next 20 years. However, the number of people at post-retirement age is growing quickly and forecast to double between 2011 and 2031. This will see an increase in the number of smaller household types, with 'lone person' and 'couple only' households making up just over half of all households in Knox within 20 years.

With an increase in population and demographic diversity, the City of Knox will continue to play an important role in housing provision and diversity.”

- *The amended proposal is considered to be consistent with the MSS. The design response now respects the low scale single and double storey nature of surrounding development, whilst allowing appropriate landscaping setbacks and building articulation to ensure the development does not dominate the streetscape.*

Clause 21.05 Built Environment and Heritage – Development should address needs of changing household structures, creating high quality, well-designed places that respect and strengthen the local context and landscape qualities of Knox. It is important to achieve environmentally sustainable development that contributes to a more liveable and sustainable Knox, including efficient use of urban water runoff and the quality of stormwater entering waterways.

Housing liveability and amenity for occupants should be improved by supporting indoor environment quality (such as access to daylight and ventilation).

- *The amended proposal provides an appropriate balance between the need for providing housing, and the amenity of area and future occupiers of the site. The combination of double storey and single storey built form, increased landscaping areas, and increased setbacks will result in a good quality urban design outcome.*

6.2 24-26 Taylors Lane, Rowville (cont'd)

Clause 21.06 – Housing: The Housing theme implements the Knox Housing Strategy 2015. In managing the City of Knox's current and future housing needs, Council supports a scaled approach to residential development. This scaled approach recognises that some parts of the City will need to accommodate change, due to population growth and the community's changing household needs. Development in residential areas will need to respond positively to the desired future character of the local area and take account of the particular built form and natural environmental elements that make up the neighbourhood character of Knox. The strong landscape character is the unifying element of the neighbourhood character of Knox.

The subject site is located within a 'Knox Neighbourhood' area, which has a sense of spaciousness within the public and private realm. These areas will continue to be low-scale neighbourhoods, characterised by detached dwellings with large backyards which contribute to the area's green and leafy character.

Objective 1 for Housing Objectives and Strategies is to support residential development in accordance with the Knox Housing Strategy 2015, which identifies a scaled approach to residential development. The strategy is to direct housing growth toward Local Living and Activity Areas.

- *The site is not located in an Activity Centre. However, the site is sufficiently large to accommodate a larger number of dwellings while achieving the open space and landscaping outcomes sought for the Knox Neighbourhood Character Area.*

Objective 2 is to support a diversity of housing choice in appropriate locations. Strategies include encouraging a diversity of housing styles, types, forms and sizes to cater for the changing needs of the community.

- *The development will provide residents with alternative forms of housing styles and sizes.*

Objective 3 is to provide residential development that allows people to 'age-in-place'. Strategies include supporting smaller scale dwellings that cater for older people, supporting new residential aged care facilities, except in Bush Suburban areas within the Dandenong Foothills or in a Site of Biological Significance, and supporting the diversification of existing aged care facilities to provide a range of housing and care levels on-site.

- *As noted above, the development will provide residents with alternative forms of housing styles and sizes. Four (4) dwellings along the rear (eastern) boundary will be single storey, contributing to the range of housing and allow people to age in place.*

6.2 24-26 Taylors Lane, Rowville (cont'd)

Objective 4 is to support high quality housing design that responds to the City's green and leafy character, local character and creates a strong sense of place.

- *The amended proposal reached at the VCAT conference (subject to Council approval) will ensure that the height, setbacks, and landscaping appropriately respect the existing and preferred character of the area.*

Objective 5 is to protect and enhance the landscape and environmental values of the nature areas of significance within the municipality.

- *The site is not located in an area of biological significance.*

Clause 22.04 – Environmentally Sustainable Development:

This new policy introduced into Knox Planning Scheme under Amendment C150 requires applicants to address Environmentally Sustainable Development (ESD) principles including energy performance, water resources, indoor environmental quality, stormwater, waste management, transport and urban ecology, by applying these principles within the proposed development.

- *The Sustainable Design Assessment submitted with the application is considered to be acceptable.*

Clause 22.07 – Development in Residential Areas and Neighbourhood Character: Knox Neighbourhood Area.

Council's Development in Residential Areas and Neighbourhood Character Policy identifies the subject site within a Knox Neighbourhood Area, where areas will continue to contribute to the protection and enhancement of Knox's distinctive environmental and biological values, and continue to be low-scale neighbourhood where significant indigenous and native vegetation is retained and complemented.

The key (relevant) design objectives are:

Design buildings to accommodate landscaping including canopy trees in front and rear gardens.

- *The amended plans include appropriate setbacks and large private open space areas to provide for canopy tree planting.*

6.2 24-26 Taylors Lane, Rowville (cont'd)

Retain existing canopy trees and understorey planting, wherever possible.

- *The proposed development ensures ample opportunities for meaningful landscaping throughout the site and will include the provision of canopy trees that will contribute to the long term amenity of the area.*
- *As noted above, the amended plans will ensure vegetation on the adjoining properties is not detrimentally affected.*

Provide a landscaped front and rear yard and plant indigenous canopy trees in accordance with the requirements of the applicable zone schedule.

- *The development provides for the planting of indigenous canopy trees in accordance with the schedule to the zone.*

In developments of three or more dwellings, ensure that the rear dwelling is single storey in height.

- *The amended plans include four (4) single storey dwellings along the rear (eastern) boundary, now complying with the policy.*

Provide single crossovers for driveways.

- *The number of crossovers to Taylors Lane has been reduced from four to three, improving landscaping opportunities within the frontage.*

Locate carports and garages behind the line of the dwelling or in the rear yard.

- *The garage to Dwelling 1 is located in line with the dwelling. The remaining garages are located behind the dwellings and to the rear of the site and therefore will not be noticeable from Taylors Lane.*

Minimise the amount of paving in front yards and driveways.

- *The extent of paving within the frontage has been suitably minimised and restricted to the access ways and pedestrian footpaths.*

Design new buildings to incorporate pitched, hipped or gabled roof forms.

- *All dwellings incorporate a pitched roof.*

Significantly setback first floor levels from the ground floor level.

- *The amended plans show that the upper levels have been reduced in size with greater separation between the dwellings, reducing building bulk and mass to the adjoining residential properties.*

6.2 24-26 Taylors Lane, Rowville (cont'd)

Provide no, low or transparent front fencing

- *No front fencing is proposed.*
- *As noted above, the amended plans have deleted the internal gates.*

Applications must also consider:

Accessible Design

- *The proposal caters for the needs of people with limited mobility as a clear and accessible path from the street to each front door has been provided. Further, there are dwellings with bedrooms, kitchen, dining/living and bathrooms at ground level.*
- *A satisfactory accessibility report was submitted with the application.*

Sustainable Design

- *The development incorporates passive solar design with north facing living areas and private open space areas.*
- *The Sustainable Design Assessment submitted with the application is satisfactory.*

Architectural Design

- *The design and scale of the amended proposal is generally consistent with the housing types encouraged in the Knox Neighbourhood Area.*
- *The development now provides an appropriate degree of visual interest and articulation to present an appropriate scale to adjoining sites.*
- *Large blank walls and facades have been avoided through the incorporation of varied building materials and finishes. The upper levels have been reduced in size and the separation between the dwellings has increased.*

Housing for Aged Persons

- *The development has not been specifically designed as a form of housing for aged persons. However, there are four (4) dwellings along the rear (eastern) boundary which are now single storey and double storey dwellings are provided with a bedroom, kitchen, dining/living and bathroom downstairs.*

6.2 24-26 Taylors Lane, Rowville (cont'd)

4.3 Particular Provisions

Clause 52.06 – Car Parking

Prior to a new use commencing or a new building being occupied the car parking spaces required under Clause 52.06-5 must be provided on the land or as approved under Clause 52.06-3 to the satisfaction of the responsible authority.

Clause 52.06-5 outlines the requisite amount of parking to be provided to each dwelling and any applicable visitor parking at a ratio of two car spaces to each three or more bedroom dwelling (with studies or studios that are separate rooms counted as a bedrooms) and one visitor space to every five dwellings for developments of five or more dwellings.

A permit may be granted to reduce or to waive the number of car spaces required by the table.

- *The proposal satisfies the car parking provision as each dwelling is provided with two (2) car parking spaces and 4 visitor car parking spaces are provided on-site.*

Clause 52.06-8 details the design standards for car parking. The provision of car parking should meet the design requirements of this Clause. An assessment of the design standards, including any areas of non-compliance are considered below:

Design Standard 1: Access ways – *Complies.*

Design Standard 2: Car Parking Spaces – *Complies.*

Design Standard 3: Gradients – *Complies.*

Design Standard 4: Mechanical Parking – *Not applicable.*

Design Standard 5: Urban Design – *Complies.*

Design Standard 6: Safety – *Complies.*

Design Standard 7: Landscaping – *Complies. Landscaping along the access way has been improved.*

4.4 Clause 55 – Two or More Dwellings on a Lot and Residential Buildings (ResCode)

Neighbourhood Character and Infrastructure

Neighbourhood Character – *The development now complies with Neighbourhood Character, refer to Section 4.2.2 above.*

6.2 24-26 Taylors Lane, Rowville (cont'd)

Residential Policy – *Complies, refer to Section 4.2 above.*

Dwelling Diversity – *Complies. The proposal now includes four (4) single storey dwellings, contributing to a range of dwelling types.*

Integration with the Street – *Complies.*

Site Layout and Building Massing

Street Setback – *Complies, the development now has a front setback ranging from 7.0 to 9.0m.*

Building Height – *Complies.*

Site Cover/Permeability – *Complies.*

Energy Efficiency – *Complies.*

Open Space – *Not applicable.*

Safety – *Complies. Entrances to the dwellings are not obscured or isolated from the common access way.*

Landscaping – *Complies, a condition of any permit to issue will require landscape plans to the satisfaction of the Responsible Authority.*

Access – *Complies.*

Parking Location – *Complies.*

Amenity Impacts

Side and rear setbacks – *Complies.*

Walls on boundaries – *Complies.*

Daylight to existing windows/north facing windows – *Complies.*

North-facing windows – *Complies.*

Overshadowing open space – *Complies.*

Overlooking – *Complies.*

Internal views – *Complies.*

Noise Impacts – *Complies. No mechanical plants and the like are proposed to be located near bedrooms of immediately adjacent existing dwellings.*

On-Site Amenity and Facilities

Accessibility – *Complies.*

Daylight to new windows – *Complies.*

Private Open Space – *Complies.*

Solar access – *Complies.*

Storage – *Complies. All dwellings are now provided with 6m³ of externally accessible storage space.*

6.2 24-26 Taylors Lane, Rowville (cont'd)

Detailed Design

Design Detail – *Complies.*

Common Property – *Complies.*

Site Services – *Complies.*

Front fence – *Complies, no front fence is proposed.*

4.5 General Decision Guidelines

Clause 65 of the Knox Planning Scheme and Section 60 of the *Planning and Environment Act 1987* set out decision guidelines/matters which the responsible authority must consider when deciding any planning application.

- *The decision guidelines of Clause 65 of the Knox Planning Scheme and Section 60 of the Planning and Environment Act (1987) have been appropriately considered.*

5. CONCLUSION

Clause 10.04 of the Knox Planning Scheme requires Council to balance relative policy objectives when making decisions to ensure resulting development is sustainable and achieves a net community gain. In this context, the amended proposal is considered appropriate given the following:

- *The development is consistent with State Policy, Clause 21.05 (Built Environment and Heritage), Clause 21.06 (Housing), Clause 22.04 (Environmentally Sustainable Development), and Clause 22.07 (Development in Residential Areas and Neighbourhood Character Policy) of the Knox Planning Scheme.*
- *The proposal complies with the General Residential Zone - Schedule 2.*
- *The development is compliant with ResCode (Clause 55 of the Knox Planning Scheme).*
- *The development provides an appropriate balance between the need for additional housing within an established residential area while ensuring the amenity of occupants and adjoining residents is not compromised.*

6. CONFIDENTIALITY

There are no confidentiality issues associated with this report.

6.2 24-26 Taylors Lane, Rowville (cont'd)**7. CONFLICT OF INTEREST**

Under section 80c of the Local Government Act 1989 officers providing advice to Council must disclose any interests, including the type of interest.

Officer Responsible – Greg Kent, Acting Manager City Planning and Building – In providing this advice as the Officer Responsible, I have no disclosable interests in this report.

Author – Nancy Neil, Acting Coordinator Planning – In providing this advice as the Author, I have no disclosable interests in this report.

RECOMMENDATION

That Council adopt the agreement reached between the parties present at the VCAT Compulsory Conference dated 19 February 2018 and 2 March 2018, that a Planning Permit be issued for the development of the land for sixteen (16) double storey dwellings and four (4) single storey dwellings (total of 20 dwellings), subject to the following conditions:

Amended Plans

1. Prior to the commencement of any buildings or works, amended plans to the satisfaction of the Responsible Authority must be submitted to and approved by the Responsible Authority. When approved, the plans will be endorsed and will then form part of the permit. The plans must be drawn to scale with dimensions and three copies must be provided. The plans must be generally in accordance with the amended plans dated 26 February 2018 but modified to show:
 - 1.1 Landscape plans in accordance with Condition 3.
 - 1.2 Relocation of the storage sheds for dwellings 1, 2, 3, 4, 17, 18, 19 and 20 so access can be achieved from common property to the private open space areas.
 - 1.3 All references to 'lattice' deleted from the plans and replaced with 'free standing capped screen'.
 - 1.4 Waste Management Plan in accordance with Condition 12.
 - 1.5 Any changes necessary to comply with Condition 11 and 12.
 - 1.6 Tree Protection Fencing shown on the plans in accordance with Conditions 14-21.

6.2 24-26 Taylors Lane, Rowville (cont'd)

Drainage

2. Prior to the issue of a building permit under the Building Act 1993 for the development, three copies of drainage plans and computations to the satisfaction of the Responsible Authority must be submitted to and approved by the Responsible Authority. When approved, the plans will be endorsed and will then form part of the permit. Construction of the drainage must be in accordance with these plans. The plans must show the following:
 - 2.1 All stormwater drainage discharge from the site connected to a legal point of discharge.
 - 2.2 The internal drains of the dwellings to be independent of each other.
 - 2.3 An on-site detention system designed by a suitably qualified Civil Engineering Consultant to ensure no net increase in stormwater discharge from the proposed development.
 - 2.4 The on-site detention system to be installed in a suitable location for easy access and maintenance.
 - 2.5 A suitable overland flow path for the entire site to the satisfaction of the Responsible Authority. Details of the overland flow path are to be included on the plans.
 - 2.6 All levels to be to AHD (Australian Height Datum).

Landscaping

3. Prior to the commencement of any buildings or works, a landscape plan to the satisfaction of the Responsible Authority and generally in accordance with plan prepared by John Patrick Landscape Architects Pty Ltd dated March 2018, Drawing No. L-TP01-Rev B, must be submitted to and approved by the Responsible Authority. When approved, the plan will be endorsed and will then form part of the permit. The plan must show:
 - 3.1 A survey (including botanical names, height and width) of all existing vegetation to be retained and / or removed.
 - 3.2 The identification and removal of all vegetation identified as an environmental weed in Knox (as outlined in Appendix 2 of Council's Landscape Guidelines for Planning Permits).
 - 3.3 Buildings and trees (including botanical names, height and width) on neighbouring properties within three metres of the boundary.

6.2 24-26 Taylors Lane, Rowville (cont'd)

- 3.4 Details of the surface finishes of pathways and driveways.
- 3.5 Details and location of all existing and proposed services including above and below ground lines, cables and pipes.
- 3.6 A planting schedule of all proposed trees, shrubs and ground covers, including botanical names, common names, pot sizes, sizes at maturity, and quantities of each plant.
- 3.7 Landscaping and planting within all open areas of the site (including additional planting within open space areas of the existing dwelling/s).
- 3.8 The plan must also show the provision of at least 32 additional trees and 2 large feature shrubs chosen from plant list 1 or 2 of Council's 'Landscape Plan Guidelines'. These canopy trees must be a minimum of 1.5 – 2.0 metres tall when planted in the following areas:
 - a) 1 large canopy tree in the front setback of Dwellings 1, 10, 11 and 20.
 - b) 2 large canopy trees in the front setback of Dwelling 11.
 - c) 2 small canopy trees in the front setback of Dwelling 1.
 - d) 1 small canopy tree in the front setback of Dwelling 10, 11 and 20.
 - e) 1 medium canopy tree in the SPOS of Dwellings 1, 2, 3, 4, 8, 9, 13, 14, 15, 17, 18, 19 and 20.
 - f) 1 small canopy tree in the SPOS of Dwellings 5, 6, 7, 10, 11, 12 and 16.
 - g) 1 large feature shrub between Dwellings 8 & 9 and 14 & 15 adjacent to the driveway.
- 3.9 Planting of this site to comprise 40% of the vegetation species to be indigenous (across all plant forms) from plant list 1 of the 'Landscape Plan Guidelines' and 40% additional native species (across all plant forms) from plant list 2 of the 'Landscape Plan Guidelines'. Remaining plant species (20%) can be indigenous, native or exotic (across all plant forms) provided they are not listed as weeds.
4. Before the occupation of the development, the landscaping works shown on the endorsed plans must be carried out and completed to the satisfaction of the responsible authority.

6.2 24-26 Taylors Lane, Rowville (cont'd)

5. The landscaping shown on the endorsed plans must be maintained to the satisfaction of the responsible authority. Any dead, diseased or damaged plants must be replaced to the satisfaction of the Responsible Authority.

General

6. All development must be in accordance with the endorsed plans.
7. The layout of buildings and works as shown on the endorsed plans must not be altered without the written consent of the Responsible Authority.
8. Once the development has started it must be continued and completed to the satisfaction of the Responsible Authority.
9. Prior to the occupation of the dwellings the development is to be completed in accordance with the endorsed plan/s to the satisfaction of the Responsible Authority.
10. All walls on the boundaries of adjoining properties must be cleaned and finished to the satisfaction of the Responsible Authority.

Sustainable Design Assessment

11. Prior to the commencement of the development the Sustainable Design Assessment from Green Rate dated 10 May 2017 must be updated to be consistent with the amended architectural plans. Three copies must be submitted to Council for endorsement. The development must be constructed and operate in accordance with the endorsed Sustainable Design Assessment.

Waste Management Plan

12. Before the development commences, a waste collection and management plan must be submitted to and approved by the Responsible Authority, demonstrating how waste collection will be undertaken on site, including the operation of the garbage and recyclables storage area. Garbage and recyclables storage and collection must be undertaken in accordance with the approved plan/documentation, and must be undertaken by a private contractor, to the satisfaction of the Responsible Authority. Council will not collect waste from the proposed development. The Waste Management Plan must be generally in accordance with that submitted from Leigh Design dated 2 February 2017 but updated to read consistent with the amended architectural plans.

6.2 24-26 Taylors Lane, Rowville (cont'd)

Street Tree Removal

13. Prior to the commencement of any buildings and works approved under this permit, all costs associated with the removal of the street tree/s (amenity value, tree and stump removal and planting and maintaining a new tree) must be paid to Council by the owner/developer. The removal and replacement of the street tree/s must be undertaken by Council.

Tree Protection Conditions for on-site vegetation and street trees

14. All works, including excavation, within the critical root zone areas of the tree/s to be retained and other critical root zones on the land must be undertaken under the supervision of a qualified Arborist to ensure that there is no unreasonable damage to the root system of trees to be retained and/or protected, to the satisfaction of the Responsible Authority. Before the development starts, the owner must submit to the Responsible Authority details of the name of the Arborist who will supervise the works and the tasks to be undertaken by the Arborist, to the satisfaction of the Responsible Authority.
15. Prior to any works commencing on the site, all trees and vegetation to be retained including tree protection zones of trees on adjoining land extending on to the site must be fenced off to create a protection zone. The protection zone must extend around the trees canopy drip-line unless an alternative tree protection zone has been approved by the responsible authority.
16. The tree protection fence must be chain link or wire mesh, comprise either wooden or steel posts set into the ground or on concrete pads, and be a minimum height of 1.4 metres. Signage must be affixed to the fence advising that the area is a tree protection zone and a no-go development area.
17. The fence and signage must be maintained throughout the construction period and removed at the completion of all construction work.
18. No temporary removal of the tree protection fence, or encroachment into the tree protection zone is permitted without the written consent of the Responsible Authority.
19. Prior to erecting the fence around the tree protection zone, all unwanted vegetation and weed species must be removed from within the zone, and the ground within the protection zone must be covered with a layer of well composted organic mulch (maximum 100mm depth). The zone must be watered at least fortnightly throughout the construction period.

6.2 24-26 Taylors Lane, Rowville (cont'd)

20. The following activities must not occur within a tree protection zone, without the written consent of the Responsible Authority:

20.1 Construction activities.

20.2 Dumping and/or storage of materials, goods and/or soil.

20.3 Trenching or excavation.

20.4 Lopping branches, nailing or affixing signs, service lines, lights etc. to the trees.

21. Prior to any works commencing on site, the Responsible Authority must be contacted to inspect the tree protection fencing.

Car Parking & Accessways

22. Before the dwellings are occupied, driveways and car parking areas must, to the satisfaction of the Responsible Authority, be:

22.1 Fully constructed to the minimum standard of 100mm reinforced concrete and available for use in accordance with the plans submitted to and approved by the Responsible Authority;

22.2 Formed to such levels and drained so that they can be used in accordance with the approved plan;

22.3 Treated with an all-weather seal or some other durable surface; and

22.4 Line-marked or provided with some other adequate means of showing the car parking spaces.

23. Parking areas and driveways must be kept available and maintained for these purposes at all times to the satisfaction of the Responsible Authority.

Fencing

24. All costs associated with the provision of the fencing must be borne by the owner/developer under this permit.

25. Prior to occupying the development all fencing must be in a good condition to the satisfaction of the Responsible Authority.

6.2 24-26 Taylors Lane, Rowville (cont'd)

Amenity During Construction

26. Upon commencement and until conclusion of the development, the developer shall ensure that the development does not adversely affect the amenity of the area in any way, including:

- 26.1 the appearance of building, works or materials on the land
- 26.2 parking of motor vehicles
- 26.3 transporting of materials or goods to or from the site
- 26.4 hours of operation
- 26.5 stockpiling of top soil or fill materials
- 26.6 air borne dust emanating from the site
- 26.7 noise
- 26.8 rubbish and litter
- 26.9 sediment runoff
- 26.10 vibration

Should the development cause undue detriment to the amenity of the area then immediate remedial measures must be undertaken to address the issue as directed by, and to the satisfaction of, the Responsible Authority.

Stormwater

27. Stormwater runoff from all buildings and hard standing surfaces must be properly collected and discharged in a complete and effective system of drains within the property and must not cause or create a nuisance to abutting properties.

External Materials

28. The external materials of the development (including the roof) must be non-reflective and finished in subdued tones and/or colours to the satisfaction of the Responsible Authority.

Permit Expiry

29. This permit will expire if one of the following circumstances applies:

- 29.1 The development is not started within two years of the date of this permit.

6.2 24-26 Taylors Lane, Rowville (cont'd)

29.2 The development is not completed within four years of the date of this permit.

In accordance with section 69 of the Planning and Environment Act 1987, an application may be submitted to the responsible authority for an extension of the periods referred to in this condition.

COUNCIL RESOLUTION

MOVED: CR. PEARCE
SECONDED: CR. SEYMOUR

That Council:

1. **Not adopt the agreement reached between parties present at the VCAT compulsory conference dated 2 March 2018.**

CARRIED

Official Minutes of Knox City Council

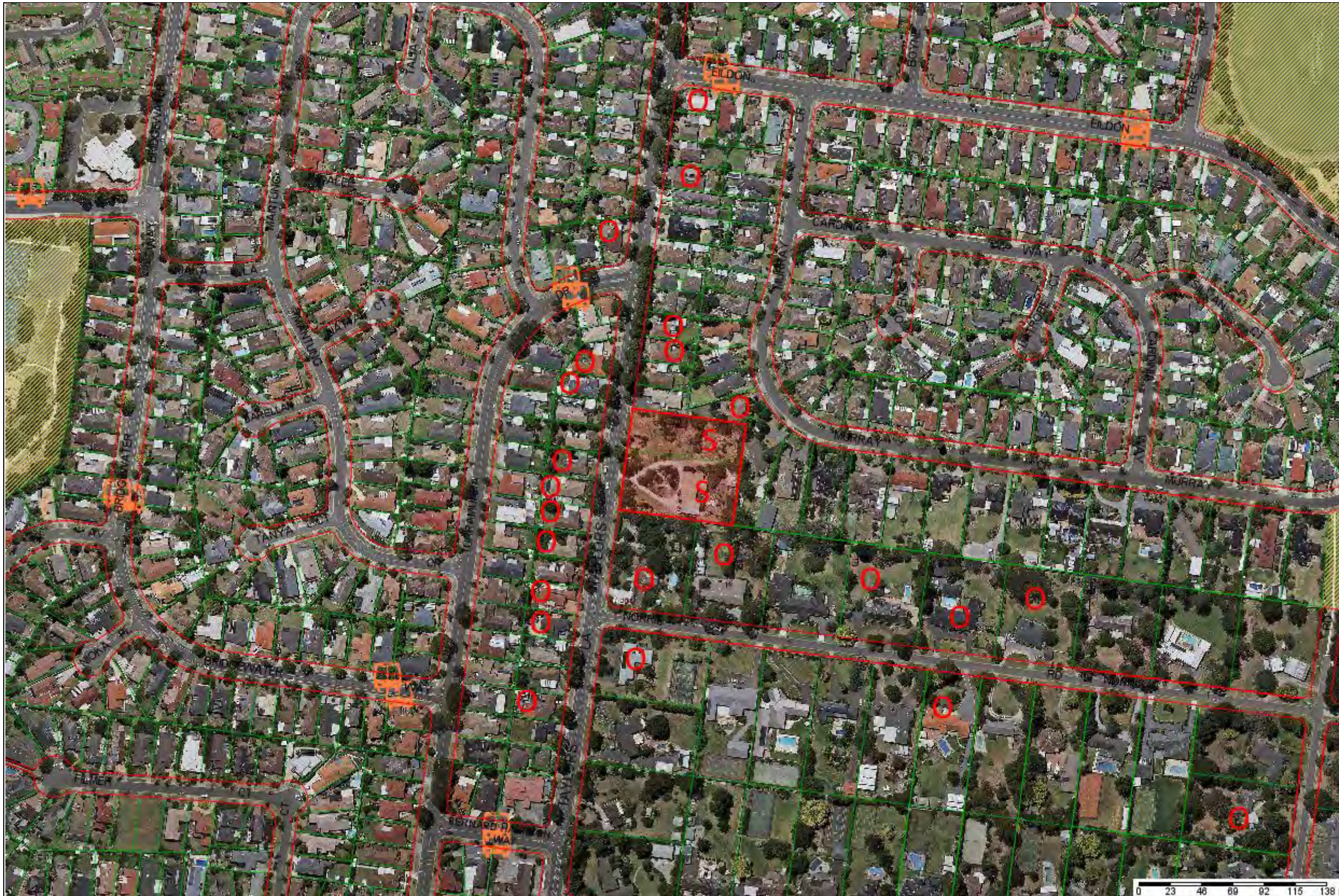

Knox City Council
REPORT APPENDIX: A

Property - Address	24-26 Taylors Lane, ROWVILLE
Application Number	P/2017/6315
Description	The construction of twenty two (22) double storey dwellings on the land
Wardname	Taylor

LEGEND:

- Title Boundary
- Road Boundaries
- City Boundary
- Bus Route
- Reserves
- Commercial Areas
- Tertiary Schools
- Primary Schools
- Secondary Schools
- P-12 School
- Bus Stops
- Objector
- Unit Development
- Subject Property
- Petition



Scale: 1:3000

DISCLAIMER:

Roads and Title Boundaries - State of Victoria, Knox City Council
 Planning Scheme Information - DPCD, Knox City Council
 Aerial Photography - AAM (Flown January 2013 – unless otherwise stated)
 Melbourne Water Drainage Information - Melbourne Water

1. Whilst every endeavor has been made to ensure that the mapping information is current and accurate, no responsibility or liability is taken by Knox City Council or any of the above organizations in respect to inaccuracy, errors, omissions or for actions based on this information.
2. Planning information should be used only as a means of preliminary investigation. For accurate overlay information please obtain a Planning Certificate from the Department of Infrastructure.
3. This print contains information from Vicmap Property (Copyright State of Victoria). The State of Victoria does not warrant the accuracy or completeness of information in this product. Any person using or relying on this information does so on the basis that the State of Victoria shall bear no responsibility or liability whatsoever for any errors, faults, defects or omissions in the information.
4. Drainage and flood extent information has been provided to Council on a yearly basis by Melbourne Water for indicative purposes only. Where the latest Melbourne Water drainage and flood extent mapping is critical, please contact Melbourne Water.

Knox City Council
REPORT APPENDIX: A

Property - Address	24-26 Taylors Lane, ROWVILLE
Application Number	P/2017/6315
Description	The construction of twenty two (22) double storey dwellings on the land
Wardname	Taylor

LEGEND:

- Title Boundary
- Road Boundaries
- City Boundary
- Bus Route
- Reserves
- Commercial Areas
- Tertiary Schools
- Primary Schools
- Secondary Schools
- P-12 School
- Bus Stops
- Objector
- Unit Development
- Subject Property
- Petition

Scale: 1:3000

0 23 46 69 92 115 138 m

DISCLAIMER:

Roads and Title Boundaries - State of Victoria, Knox City Council
 Planning Scheme Information - DPCD, Knox City Council
 Aerial Photography - AAM (Flown January 2013 – unless otherwise stated)
 Melbourne Water Drainage Information - Melbourne Water

1. Whilst every endeavor has been made to ensure that the mapping information is current and accurate, no responsibility or liability is taken by Knox City Council or any of the above organizations in respect to inaccuracy, errors, omissions or for actions based on this information.
2. Planning information should be used only as a means of preliminary investigation. For accurate overlay information please obtain a Planning Certificate from the Department of Infrastructure.
3. This print contains information from Vicmap Property (Copyright State of Victoria). The State of Victoria does not warrant the accuracy or completeness of information in this product. Any person using or relying on this information does so on the basis that the State of Victoria shall bear no responsibility or liability whatsoever for any errors, faults, defects or omissions in the information.
4. Drainage and flood extent information has been provided to Council on a yearly basis by Melbourne Water for indicative purposes only. Where the latest Melbourne Water drainage and flood extent mapping is critical, please contact Melbourne Water.

**PROPOSAL FOR 22 DOUBLE STOREY TOWNHOUSES
AT 24-26 TAYLORS LANE, ROWVILLE**

TOWN PLANNING DRAWING LIST:

- TP00 - COVER SHEET
- TP01 - SITE LOCATION PLAN
- TP02 - NEIGHBORHOOD CHARACTER & SITE ANALYSIS
- TP03 - DESIGN RESPONSE
- TP04 - DEMOLITION PLAN & STREETSCAPES
- TP05 - SITE PLAN
- TP06 - GROUND FLOOR PLAN
- TP07 - FIRST FLOOR PLAN
- TP08 - ROOF PLAN
- TP09 - PROPOSED ELEVATIONS
- TP10 - PROPOSED INTERNAL ELEVATIONS
- TP11 - FRONT FENCE ELEVATION & RAMP SECTIONS
- TP12 - SHADOW DIAGRAMS
- TP13 - SHADOW DIAGRAMS

Official Minutes of Knox City Council

APPENDIX B 24-26 TAYLORS LANE ROWVILLE

Notes
 - DO NOT SCALE FROM DRAWINGS.
 - SITE & FLOOR LEVELS TO BE CONFIRMED ON SITE BY BUILDER PRIOR TO COMMENCEMENT OF ANY WORKS. ANY ERRORS, DISCREPANCIES OR OMISSIONS IN THE DRAWINGS, NOTATIONS OR DIMENSIONS SHALL BE IMMEDIATELY BROUGHT TO THE ATTENTION OF THE ARCHITECT FOR CLARIFICATION PRIOR TO WORKS COMMENCING.
 - ARCHITECTURAL DRAWINGS TO BE READ IN CONJUNCTION WITH SPECIFICATIONS.
 - STRUCTURAL, MECHANICAL, ELECTRICAL, HYDRAULIC, LANDSCAPE ARCHITECTURAL DRAWINGS. LOCATION OF ALL HARDWARE, FIXTURES AND FITTINGS TO BE CONFIRMED WITH ARCHITECT PRIOR TO WORKS COMMENCING.

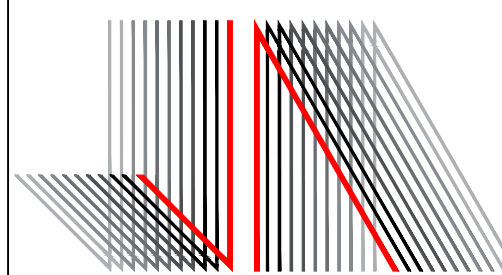

JESSE ANT ARCHITECTS
 6 / 1153-1157 Burke Road , Kew VIC 3101
 Ph: (03) 9817 6788
 Email: info@jesseantarchitects.com.au; www.jesseantarchitects.com.au
 ABN: 29 469 352 797

Project	24-26 TAYLORS LANE, ROWVILLE
Drawing	COVER SHEET

Date	Rev	Description
26.04.17	A	TP Submission
07.07.17	B	Response to RFI

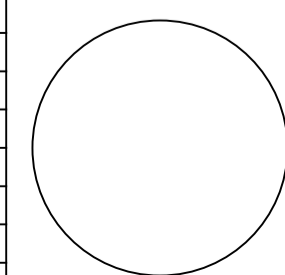

Project Number		15031		Drawing Number	TP00
Date	07-07-2017	Scale		Amendment	
Drawn	YZ	Checked	AL /JW		B

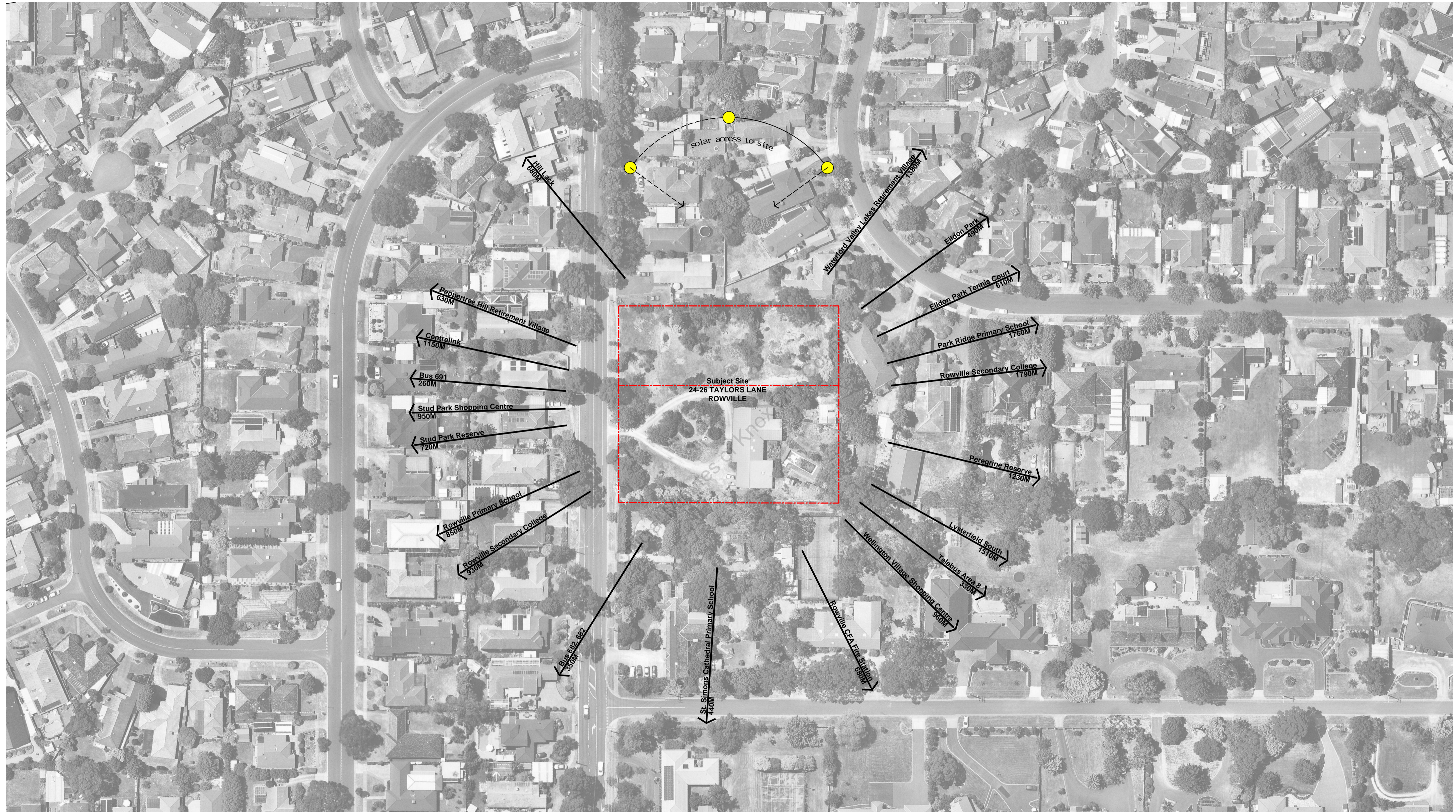

SITE LOCATION PLAN
SCALE 1:800 @ A1

APPENDIX B 24-26 TAYLORS LANE ROWVILLE

Notes
 - DO NOT SCALE FROM DRAWINGS.
 - SITE & FLOOR LEVELS TO BE CONFIRMED ON SITE BY BUILDER PRIOR TO COMMENCEMENT OF ANY WORKS. ANY ERRORS, DISCREPANCIES OR OMISSIONS IN THE DRAWINGS, NOTATIONS OR DIMENSIONS SHALL BE IMMEDIATELY BROUGHT TO THE ATTENTION OF THE ARCHITECT FOR CLARIFICATION PRIOR TO WORKS COMMENCING.
 - ARCHITECTURAL DRAWINGS TO BE READ IN CONJUNCTION WITH SPECIFICATIONS, STRUCTURAL, MECHANICAL, ELECTRICAL, HYDRAULIC, LANDSCAPE ARCHITECTURAL DRAWINGS. LOCATION OF ALL HARDWARE, FIXTURES AND FITTINGS TO BE CONFIRMED WITH ARCHITECT PRIOR TO WORKS COMMENCING.

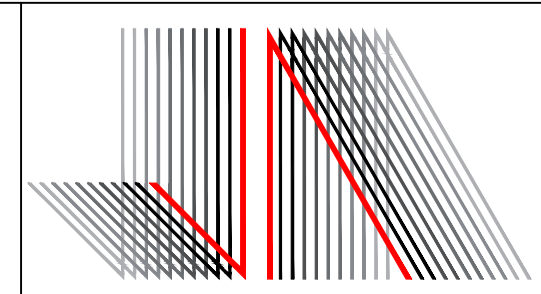

JESSE ANT ARCHITECTS
 6 / 1153-1157 Burke Road , Kew VIC 3101
 Ph: (03) 9817 6788
 Email: info@jesseantarchitects.com.au; www.jesseantarchitects.com.au
 ABN: 29 469 352 797

Project	24-26 TAYLORS LANE, ROWVILLE
Drawing	SITE LOCATION PLAN

Date	Rev	Description
26.04.17	A	TP Submission
07.07.17	B	Response to RFI

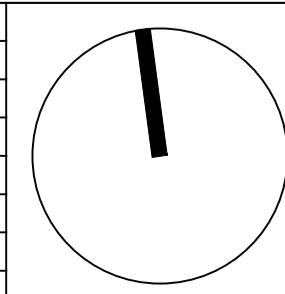

Project Number		15031		Drawing Number	TP01
Date	07-07-2017	Scale	1:800	Amendment	B
Drawn	YZ	Checked	AL/JW		



APPENDIX B 24-26 TAYLORS LANE ROWVILLE

NEIGHBORHOOD CHARACTER
SCALE 1:400 @ A1

Notes
 - DO NOT SCALE FROM DRAWINGS.
 - SITE & FLOOR LEVELS TO BE CONFIRMED ON SITE BY BUILDER PRIOR TO COMMENCEMENT OF ANY WORKS. ANY ERRORS, DISCREPANCIES OR OMISSIONS IN THE DRAWINGS, NOTATIONS OR DIMENSIONS SHALL BE IMMEDIATELY BROUGHT TO THE ATTENTION OF THE ARCHITECT FOR CLARIFICATION PRIOR TO WORKS COMMENCING.
 - ARCHITECTURAL DRAWINGS TO BE READ IN CONJUNCTION WITH SPECIFICATIONS, STRUCTURAL, MECHANICAL, ELECTRICAL, HYDRAULIC, LANDSCAPE ARCHITECTURAL DRAWINGS. LOCATION OF ALL HARDWARE, FIXTURES AND FITTINGS TO BE CONFIRMED WITH ARCHITECT PRIOR TO WORKS COMMENCING.

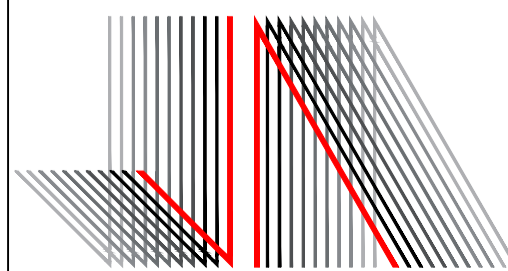

JESSE ANT ARCHITECTS
 6 / 1153-1157 Burke Road , Kew VIC 3101
 Ph: (03) 9817 6788
 Email: info@jesseantarchitects.com.au; www.jesseantarchitects.com.au
 ABN: 29 469 352 797

Project	6 / 1153-1157 Burke Road , Kew VIC 3101
Drawing	NEIGHBORHOOD CHARACTER

Date	Rev	Description
26.04.17	A	TP Submission
07.07.17	B	Response to RFI

Project Number		15031		Drawing Number	TP02
Date	07-07-2017	Scale	1:400	Amendment	B
Drawn	YZ	Checked	AL/JW		



APPENDIX B 24-26 TAYLORS LANE ROWVILLE

DESIGN RESPONSE
SCALE 1:400 @ A1

Notes
 - DO NOT SCALE FROM DRAWINGS.
 - SITE & FLOOR LEVELS TO BE CONFIRMED ON SITE BY BUILDER PRIOR TO COMMENCEMENT OF ANY WORKS. ANY ERRORS, DISCREPANCIES OR OMISSIONS IN THE DRAWINGS, NOTATIONS OR DIMENSIONS SHALL BE IMMEDIATELY BROUGHT TO THE ATTENTION OF THE ARCHITECT FOR CLARIFICATION PRIOR TO WORKS COMMENCING.
 - ARCHITECTURAL DRAWINGS TO BE READ IN CONJUNCTION WITH SPECIFICATIONS, STRUCTURAL, MECHANICAL, ELECTRICAL, HYDRAULIC, LANDSCAPE ARCHITECTURAL DRAWINGS. LOCATION OF ALL HARDWARE, FIXTURES AND FITTINGS TO BE CONFIRMED WITH ARCHITECT PRIOR TO WORKS COMMENCING.

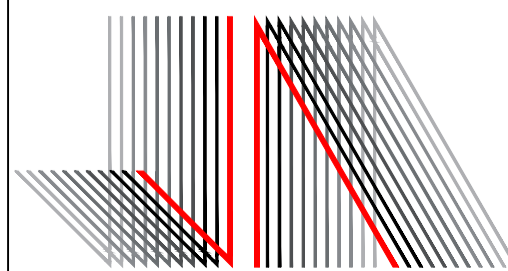

JESSE ANT ARCHITECTS
 6 / 1153-1157 Burke Road , Kew VIC 3101
 Ph: (03) 9817 6788
 Email: info@jesseantarchitects.com.au; www.jesseantarchitects.com.au
 ABN: 29 469 352 797

Project	24-26 TAYLORS LANE, ROWVILLE
Drawing	DESIGN RESPONSE

Date	Rev	Description
26.04.17	A	TP Submission
07.07.17	B	Response to RFI

Project Number		15031		Drawing Number		TP03	
Date	07-07-2017	Scale	1:400	Amendment		B	
Drawn	YZ	Checked	AL/JW				

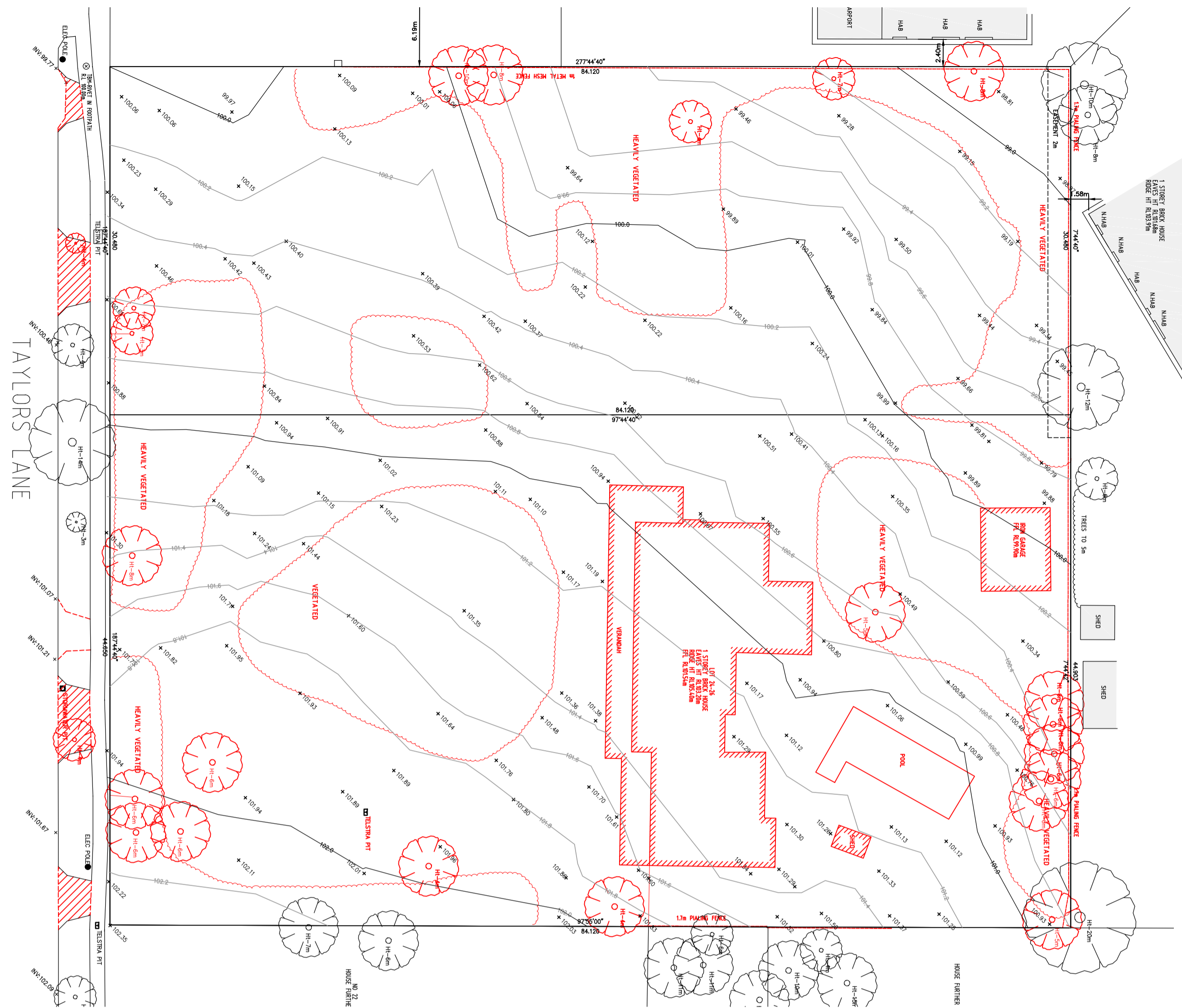

DEMOLITION NOTES:

- EXISTING TREES TO BE REMOVED (SHOWN IN RED)
- EXISTING STRUCTURE TO BE REMOVED (SHOWN IN RED)

DEMOLITION PLAN
SCALE 1:300 @ A1

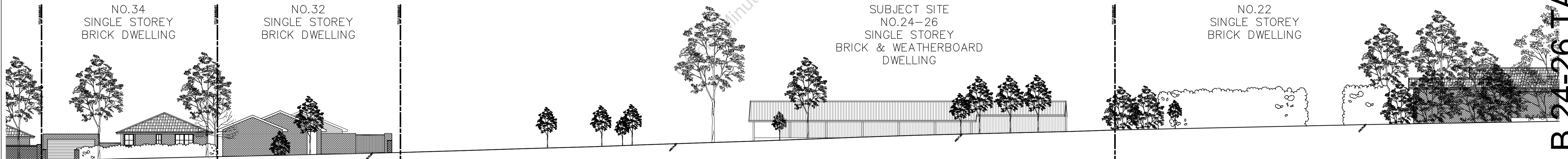

EXISTING STREETSCAPE
SCALE 1:200 @ A1



PROPOSED STREETSCAPE
SCALE 1:200 @ A1

Notes

- DO NOT SCALE FROM DRAWINGS.
- SITE & FLOOR LEVELS TO BE CONFIRMED ON SITE BY BUILDER PRIOR TO COMMENCEMENT OF ANY WORKS. ANY ERRORS, DISCREPANCIES OR OMISSIONS IN THE DRAWINGS, NOTATIONS OR DIMENSIONS SHALL BE IMMEDIATELY BROUGHT TO THE ATTENTION OF THE ARCHITECT FOR CLARIFICATION PRIOR TO WORKS COMMENCING.
- ARCHITECTURAL DRAWINGS TO BE READ IN CONJUNCTION WITH SPECIFICATIONS, STRUCTURAL, MECHANICAL, ELECTRICAL, HYDRAULIC, LANDSCAPE ARCHITECTURAL DRAWINGS. LOCATION OF ALL HARDWARE, FIXTURES AND FITTINGS TO BE CONFIRMED WITH ARCHITECT PRIOR TO WORKS COMMENCING.

JESSE ANT ARCHITECTS
6 / 1153-1157 Burke Road, Kew VIC 3101
Ph: (03) 9817 6788
Email: info@jesseantarchitects.com.au; www.jesseantarchitects.com.au
ABN: 29 469 352 797

Project	24-26 TAYLORS LANE, ROWVILLE
Drawing	DEMOLITION PLAN & STREETSCAPES

Date	Rev	Description
26.04.17	A	TP Submission
07.07.17	B	Response to RFI

	Project Number 15031		Drawing Number TP04
	Date 07-07-2017	Scale	Amendment B
Drawn	YZ	Checked	AL/JW

APPENDIX B 24-26 TAYLORS LANE ROWVILLE



SITE PLAN
SCALE 1:200 @ A1

Development Summary:

Unit 1	Site Coverage: F1 B1 A	Unit 12	Site Coverage: F1 B1 A
Ground Floor Area: F1 B1 A	Ground Floor Area: F1 B1 A	Ground Floor Area: F1 B1 A	Ground Floor Area: F1 B1 A
First Floor Area: F1 B1 A	First Floor Area: F1 B1 A	First Floor Area: F1 B1 A	First Floor Area: F1 B1 A
SPOS > 5m: F1 B1 A	SPOS > 5m: F1 B1 A	SPOS > 5m: F1 B1 A	SPOS > 5m: F1 B1 A
Total POS: F1 B1 A	Total POS: F1 B1 A	Total POS: F1 B1 A	Total POS: F1 B1 A
No. of Bed: 4	No. of Bed: 4	No. of Bed: 4	No. of Bed: 4
No. of Car Space: 2	No. of Car Space: 2	No. of Car Space: 2	No. of Car Space: 2
Storage: 1	Storage: 1	Storage: 1	Storage: 1

Unit 2	Site Coverage: F1 B1 A	Unit 13	Site Coverage: F1 B1 A
Ground Floor Area: F1 B1 A	Ground Floor Area: F1 B1 A	Ground Floor Area: F1 B1 A	Ground Floor Area: F1 B1 A
First Floor Area: F1 B1 A	First Floor Area: F1 B1 A	First Floor Area: F1 B1 A	First Floor Area: F1 B1 A
SPOS > 5m: F1 B1 A	SPOS > 5m: F1 B1 A	SPOS > 5m: F1 B1 A	SPOS > 5m: F1 B1 A
Total POS: F1 B1 A	Total POS: F1 B1 A	Total POS: F1 B1 A	Total POS: F1 B1 A
No. of Bed: 4	No. of Bed: 4	No. of Bed: 4	No. of Bed: 4
No. of Car Space: 2	No. of Car Space: 2	No. of Car Space: 2	No. of Car Space: 2
Storage: 1	Storage: 1	Storage: 1	Storage: 1

Unit 3	Site Coverage: F1 B1 A	Unit 14	Site Coverage: F1 B1 A
Ground Floor Area: F1 B1 A	Ground Floor Area: F1 B1 A	Ground Floor Area: F1 B1 A	Ground Floor Area: F1 B1 A
First Floor Area: F1 B1 A	First Floor Area: F1 B1 A	First Floor Area: F1 B1 A	First Floor Area: F1 B1 A
SPOS > 5m: F1 B1 A	SPOS > 5m: F1 B1 A	SPOS > 5m: F1 B1 A	SPOS > 5m: F1 B1 A
Total POS: F1 B1 A	Total POS: F1 B1 A	Total POS: F1 B1 A	Total POS: F1 B1 A
No. of Bed: 4	No. of Bed: 4	No. of Bed: 4	No. of Bed: 4
No. of Car Space: 2	No. of Car Space: 2	No. of Car Space: 2	No. of Car Space: 2
Storage: 1	Storage: 1	Storage: 1	Storage: 1

Unit 4	Site Coverage: F1 B1 A	Unit 15	Site Coverage: F1 B1 A
Ground Floor Area: F1 B1 A	Ground Floor Area: F1 B1 A	Ground Floor Area: F1 B1 A	Ground Floor Area: F1 B1 A
First Floor Area: F1 B1 A	First Floor Area: F1 B1 A	First Floor Area: F1 B1 A	First Floor Area: F1 B1 A
SPOS > 5m: F1 B1 A	SPOS > 5m: F1 B1 A	SPOS > 5m: F1 B1 A	SPOS > 5m: F1 B1 A
Total POS: F1 B1 A	Total POS: F1 B1 A	Total POS: F1 B1 A	Total POS: F1 B1 A
No. of Bed: 4	No. of Bed: 4	No. of Bed: 4	No. of Bed: 4
No. of Car Space: 2	No. of Car Space: 2	No. of Car Space: 2	No. of Car Space: 2
Storage: 1	Storage: 1	Storage: 1	Storage: 1

Unit 5	Site Coverage: F1 B1 A	Unit 16	Site Coverage: F1 B1 A
Ground Floor Area: F1 B1 A	Ground Floor Area: F1 B1 A	Ground Floor Area: F1 B1 A	Ground Floor Area: F1 B1 A
First Floor Area: F1 B1 A	First Floor Area: F1 B1 A	First Floor Area: F1 B1 A	First Floor Area: F1 B1 A
SPOS > 5m: F1 B1 A	SPOS > 5m: F1 B1 A	SPOS > 5m: F1 B1 A	SPOS > 5m: F1 B1 A
Total POS: F1 B1 A	Total POS: F1 B1 A	Total POS: F1 B1 A	Total POS: F1 B1 A
No. of Bed: 4	No. of Bed: 4	No. of Bed: 4	No. of Bed: 4
No. of Car Space: 2	No. of Car Space: 2	No. of Car Space: 2	No. of Car Space: 2
Storage: 1	Storage: 1	Storage: 1	Storage: 1

Unit 6	Site Coverage: F1 B1 A	Unit 17	Site Coverage: F1 B1 A
Ground Floor Area: F1 B1 A	Ground Floor Area: F1 B1 A	Ground Floor Area: F1 B1 A	Ground Floor Area: F1 B1 A
First Floor Area: F1 B1 A	First Floor Area: F1 B1 A	First Floor Area: F1 B1 A	First Floor Area: F1 B1 A
SPOS > 5m: F1 B1 A	SPOS > 5m: F1 B1 A	SPOS > 5m: F1 B1 A	SPOS > 5m: F1 B1 A
Total POS: F1 B1 A	Total POS: F1 B1 A	Total POS: F1 B1 A	Total POS: F1 B1 A
No. of Bed: 4	No. of Bed: 4	No. of Bed: 4	No. of Bed: 4
No. of Car Space: 2	No. of Car Space: 2	No. of Car Space: 2	No. of Car Space: 2
Storage: 1	Storage: 1	Storage: 1	Storage: 1

Unit 7	Site Coverage: F1 B1 A	Unit 18	Site Coverage: F1 B1 A
Ground Floor Area: F1 B1 A	Ground Floor Area: F1 B1 A	Ground Floor Area: F1 B1 A	Ground Floor Area: F1 B1 A
First Floor Area: F1 B1 A	First Floor Area: F1 B1 A	First Floor Area: F1 B1 A	First Floor Area: F1 B1 A
SPOS > 5m: F1 B1 A	SPOS > 5m: F1 B1 A	SPOS > 5m: F1 B1 A	SPOS > 5m: F1 B1 A
Total POS: F1 B1 A	Total POS: F1 B1 A	Total POS: F1 B1 A	Total POS: F1 B1 A
No. of Bed: 2	No. of Bed: 4	No. of Bed: 4	No. of Bed: 4
No. of Car Space: 1	No. of Car Space: 2	No. of Car Space: 2	No. of Car Space: 2
Storage: 1	Storage: 1	Storage: 1	Storage: 1

Unit 8	Site Coverage: F1 B1 A	Unit 19	Site Coverage: F1 B1 A
Ground Floor Area: F1 B1 A	Ground Floor Area: F1 B1 A	Ground Floor Area: F1 B1 A	Ground Floor Area: F1 B1 A
First Floor Area: F1 B1 A	First Floor Area: F1 B1 A	First Floor Area: F1 B1 A	First Floor Area: F1 B1 A
SPOS > 5m: F1 B1 A	SPOS > 5m: F1 B1 A	SPOS > 5m: F1 B1 A	SPOS > 5m: F1 B1 A
Total POS: F1 B1 A	Total POS: F1 B1 A	Total POS: F1 B1 A	Total POS: F1 B1 A
No. of Bed: 3	No. of Bed: 4	No. of Bed: 4	No. of Bed: 4
No. of Car Space: 2	No. of Car Space: 2	No. of Car Space: 2	No. of Car Space: 2
Storage: 1	Storage: 1	Storage: 1	Storage: 1

Unit 9	Site Coverage: F1 B1 A	Unit 20	Site Coverage: F1 B1 A
Ground Floor Area: F1 B1 A	Ground Floor Area: F1 B1 A	Ground Floor Area: F1 B1 A	Ground Floor Area: F1 B1 A
First Floor Area: F1 B1 A	First Floor Area: F1 B1 A	First Floor Area: F1 B1 A	First Floor Area: F1 B1 A
SPOS > 5m: F1 B1 A	SPOS > 5m: F1 B1 A	SPOS > 5m: F1 B1 A	SPOS > 5m: F1 B1 A
Total POS: F1 B1 A	Total POS: F1 B1 A	Total POS: F1 B1 A	Total POS: F1 B1 A
No. of Bed: 3	No. of Bed: 4	No. of Bed: 4	No. of Bed: 4
No. of Car Space: 2	No. of Car Space: 2	No. of Car Space: 2	No. of Car Space: 2
Storage: 1	Storage: 1	Storage: 1	Storage: 1

Unit 10	Site Coverage: F1 B1 A	Unit 21	Site Coverage: F1 B1 A
Ground Floor Area: F1 B1 A	Ground Floor Area: F1 B1 A	Ground Floor Area: F1 B1 A	Ground Floor Area: F1 B1 A
First Floor Area: F1 B1 A	First Floor Area: F1 B1 A	First Floor Area: F1 B1 A	First Floor Area: F1 B1 A
SPOS > 5m: F1 B1 A	SPOS > 5m: F1 B1 A	SPOS > 5m: F1 B1 A	SPOS > 5m: F1 B1 A
Total POS: F1 B1 A	Total POS: F1 B1 A	Total POS: F1 B1 A	Total POS: F1 B1 A
No. of Bed: 3	No. of Bed: 4	No. of Bed: 4	No. of Bed: 4
No. of Car Space: 2	No. of Car Space: 2	No. of Car Space: 2	No. of Car Space: 2
Storage: 1	Storage: 1	Storage: 1	Storage: 1

Unit 11	Site Coverage: F1 B1 A	Unit 22	Site Coverage: F1 B1 A
Ground Floor Area: F1 B1 A	Ground Floor Area: F1 B1 A	Ground Floor Area: F1 B1 A	Ground Floor Area: F1 B1 A
First Floor Area: F1 B1 A	First Floor Area: F1 B1 A	First Floor Area: F1 B1 A	First Floor Area: F1 B1 A
SPOS > 5m: F1 B1 A	SPOS > 5m: F1 B1 A	SPOS > 5m: F1 B1 A	SPOS > 5m: F1 B1 A
Total POS: F1 B1 A	Total POS: F1 B1 A	Total POS: F1 B1 A	Total POS: F1 B1 A
No. of Bed: 4	No. of Bed: 4	No. of Bed: 4	No. of Bed: 4
No. of Car Space: 2	No. of Car Space: 2	No. of Car Space: 2	No. of Car Space: 2
Storage: 1	Storage: 1	Storage: 1	Storage: 1

Notes

- DO NOT SCALE FROM DRAWINGS.
- SITE & FLOOR LEVELS TO BE CONFIRMED ON SITE BY BUILDER PRIOR TO COMMENCEMENT OF ANY WORKS. ANY ERRORS, DISCREPANCIES OR OMISSIONS IN THE DRAWINGS, NOTATIONS OR DIMENSIONS SHALL BE IMMEDIATELY BROUGHT TO THE ATTENTION OF THE ARCHITECT FOR CLARIFICATION PRIOR TO WORKS COMMENCING.
- ARCHITECTURAL DRAWINGS TO BE READ IN CONJUNCTION WITH SPECIFICATIONS, STRUCTURAL, MECHANICAL, ELECTRICAL, HYDRAULIC, LANDSCAPE ARCHITECTURAL DRAWINGS. LOCATION OF ALL HARDWARE, FIXTURES AND FITTINGS TO BE CONFIRMED WITH ARCHITECT PRIOR TO WORKS COMMENCING.

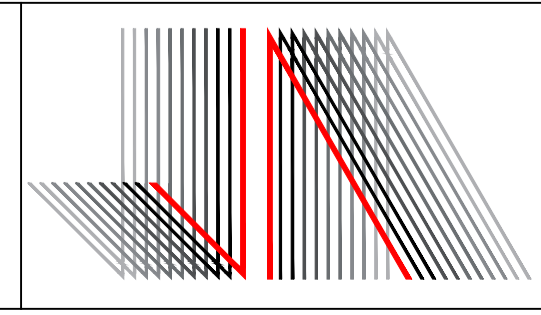

JESSE ANT ARCHITECTS
 6 / 1153-1157 Burke Road , Kew VIC 3101
 Ph: (03) 9817 6788
 Email: info@jesseantarchitects.com.au; www.jesseantarchitects.com.au
 ABN: 29 469 352 797

Project	24-26 TAYLORS LANE, ROWVILLE
Drawing	SITE PLAN

Date	Rev	Description
26.04.17	A	TP Submission
07.07.17	B	Response to RFI

Project Number	15031	Drawing Number	TP05
Date	07-07-2017	Scale	1:200
Drawn	YZ	Checked	AL/JW
		Amendment	B

LEGEND

- DENOTES TREE IDENTIFICATION NUMBER MENTIONED IN ARBORIST REPORT
- DENOTE TREE PROTECTION ZONE & STRUCTURE ROOT ZONE
- DENOTE AREA OF STRUCTURE ENCRDACH INTO THE TREE PROTECTION ZONE
- DENOTE EXISTING TREES OR SHRUBS TO BE REMOVED
- DENOTE PROPOSED INDIGENOUS CANDOPY TREE
- DENOTES LAWN, GARDEN BED AND EXTERNAL PERVIOUS SOFTSCAPED AREAS.
- DENOTE SELECTED CONCRETE DRIVEWAY
- DENOTE SELECTED PAVED AREA TO BE LAND ON POROUS COMPACTED SAND BASE
- DENOTE SPACE TIMBER DECKING WITH PERMEABLE SOIL AREA UNDERNEATH
- DENOTE SELECTED PERMEABLE DRIVEWAY
- DENOTES 6 CUBIC METRES OF STORAGE SHED
- DENOTE SELECTED CLOTHESLINE LOCATION
- DENOTE SELECTED MAIL BOX LOCATION
- DENOTE SELECTED ELECTRICITY METER BOX LOCATION
- DENOTE 3000L S-LINE RAINWATER TANK

NOTE:

- THE ROOF AREAS FOR EACH DWELLINGS WILL BE CONNECTED TO EACH RAINWATER TANKS.
- ALL TOILETS WILL BE CONNECTED TO THE RAINWATER TANKS.
- ALL INTERNAL FENCES ARE TIMBER PAILING FENCE TO 1.8M HIGH ABOVE PROPOSED GROUND LEVEL/RETAINING WALL

GROUND FLOOR PLAN

SCALE 1:150 @ A1

Notes

- DO NOT SCALE FROM DRAWINGS.
- SITE & FLOOR LEVELS TO BE CONFIRMED ON SITE BY BUILDER PRIOR TO COMMENCEMENT OF ANY WORKS. ANY ERRORS, DISCREPANCIES OR OMISSIONS IN THE DRAWINGS, NOTATIONS OR DIMENSIONS SHALL BE IMMEDIATELY BROUGHT TO THE ATTENTION OF THE ARCHITECT FOR CLARIFICATION PRIOR TO WORKS COMMENCING.
- ARCHITECTURAL DRAWINGS TO BE READ IN CONJUNCTION WITH SPECIFICATIONS, STRUCTURAL, MECHANICAL, ELECTRICAL, HYDRAULIC, LANDSCAPE ARCHITECTURAL DRAWINGS.
- LOCATION OF ALL HARDWARE, FIXTURES AND FITTINGS TO BE CONFIRMED WITH ARCHITECT PRIOR TO WORKS COMMENCING.

JESSE ANT ARCHITECTS
 6 / 1153-1157 Burke Road , Kew VIC 3101
 Ph: (03) 9817 6788
 Email: info@jesseantarchitects.com.au; www.jesseantarchitects.com.au
 ABN: 29 469 352 797

Project	24-26 TAYLORS LANE, ROWVILLE
Drawing	GROUND FLOOR PLAN

Date	Rev	Description
26.04.17	A	TP Submission
07.07.17	B	Response to RFI

Project Number	15031	Drawing Number	TP06
Date	07-07-2017	Scale	1:150
Drawn	YZ	Checked	AL/JW
		Amendment	B

APPENDIX B 24-26 TAYLORS LANE ROWVILLE

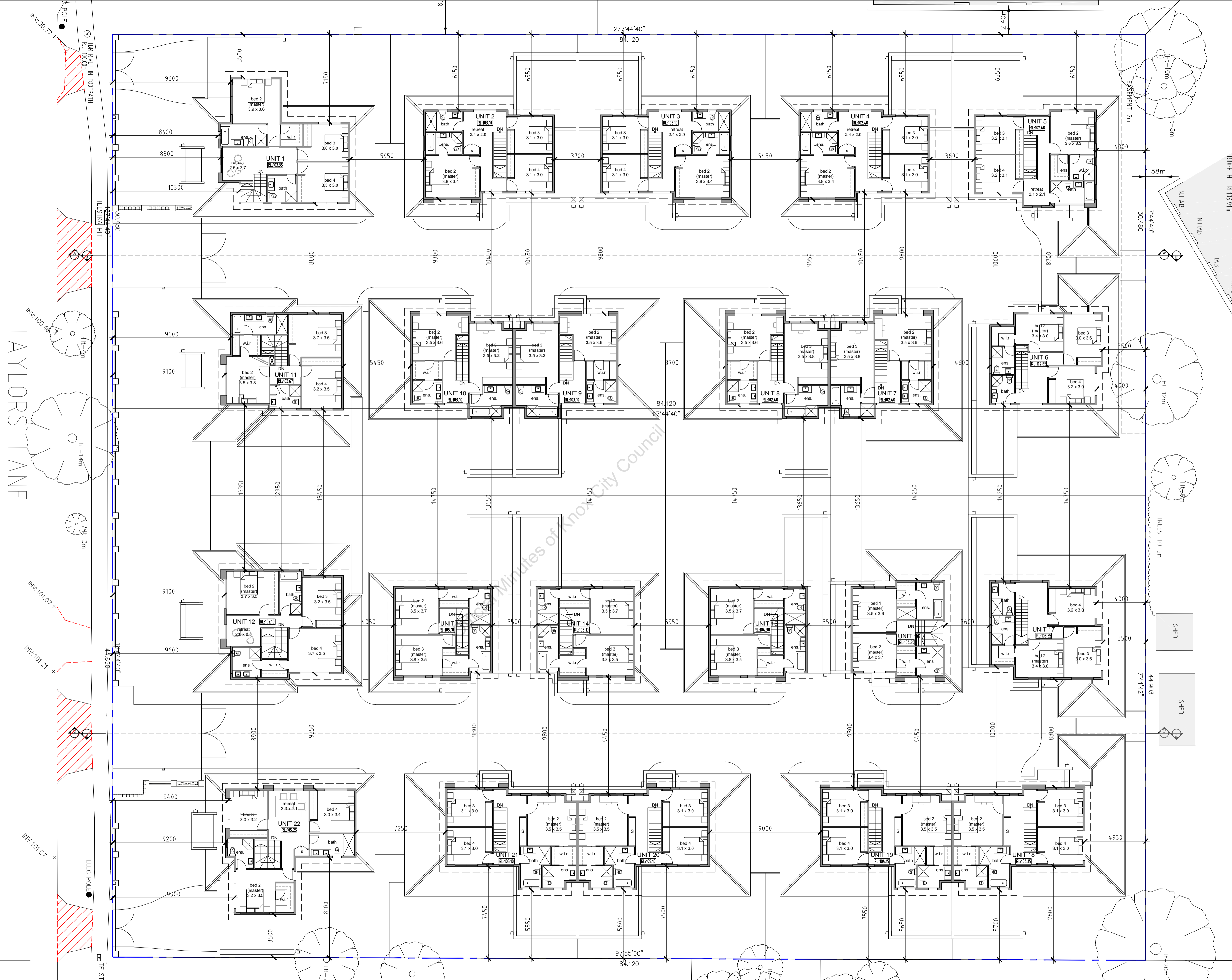

FIRST FLOOR PLAN
SCALE 1:150 @ A1

Notes
 - DO NOT SCALE FROM DRAWINGS.
 - SITE & FLOOR LEVELS TO BE CONFIRMED ON SITE BY BUILDER PRIOR TO COMMENCEMENT OF ANY WORKS. ANY ERRORS, DISCREPANCIES OR OMISSIONS IN THE DRAWINGS, NOTATIONS OR DIMENSIONS SHALL BE IMMEDIATELY BROUGHT TO THE ATTENTION OF THE ARCHITECT FOR CLARIFICATION PRIOR TO WORKS COMMENCING.
 - ARCHITECTURAL DRAWINGS TO BE READ IN CONJUNCTION WITH SPECIFICATIONS, STRUCTURAL, MECHANICAL, ELECTRICAL, HYDRAULIC, LANDSCAPE ARCHITECTURAL DRAWINGS. LOCATION OF ALL HARDWARE, FIXTURES AND FITTINGS TO BE CONFIRMED WITH ARCHITECT PRIOR TO WORKS COMMENCING.

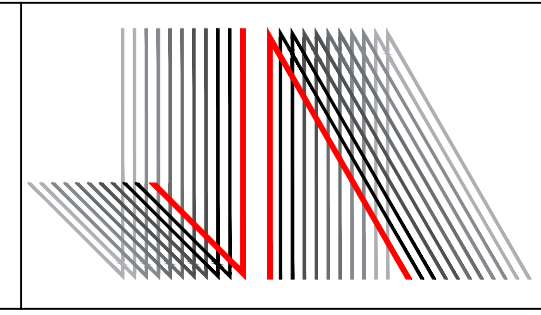

JESSE ANT ARCHITECTS
 6 / 1153-1157 Burke Road , Kew VIC 3101
 Ph: (03) 9817 6788
 Email: info@jesseantarchitects.com.au; www.jesseantarchitects.com.au
 ABN: 29 469 352 797

Project	24-26 TAYLORS LANE, ROWVILLE
Drawing	FIRST FLOOR PLAN

Date	Rev	Description
26.04.17	A	TP Submission
07.07.17	B	Response to RFI

Project Number		15031		Drawing Number		TP07	
Date	07-07-2017	Scale	1:150	Amendment		B	
Drawn	YZ	Checked	AL/JW				

APPENDIX B 24-26 TAYLORS LANE ROWVILLE

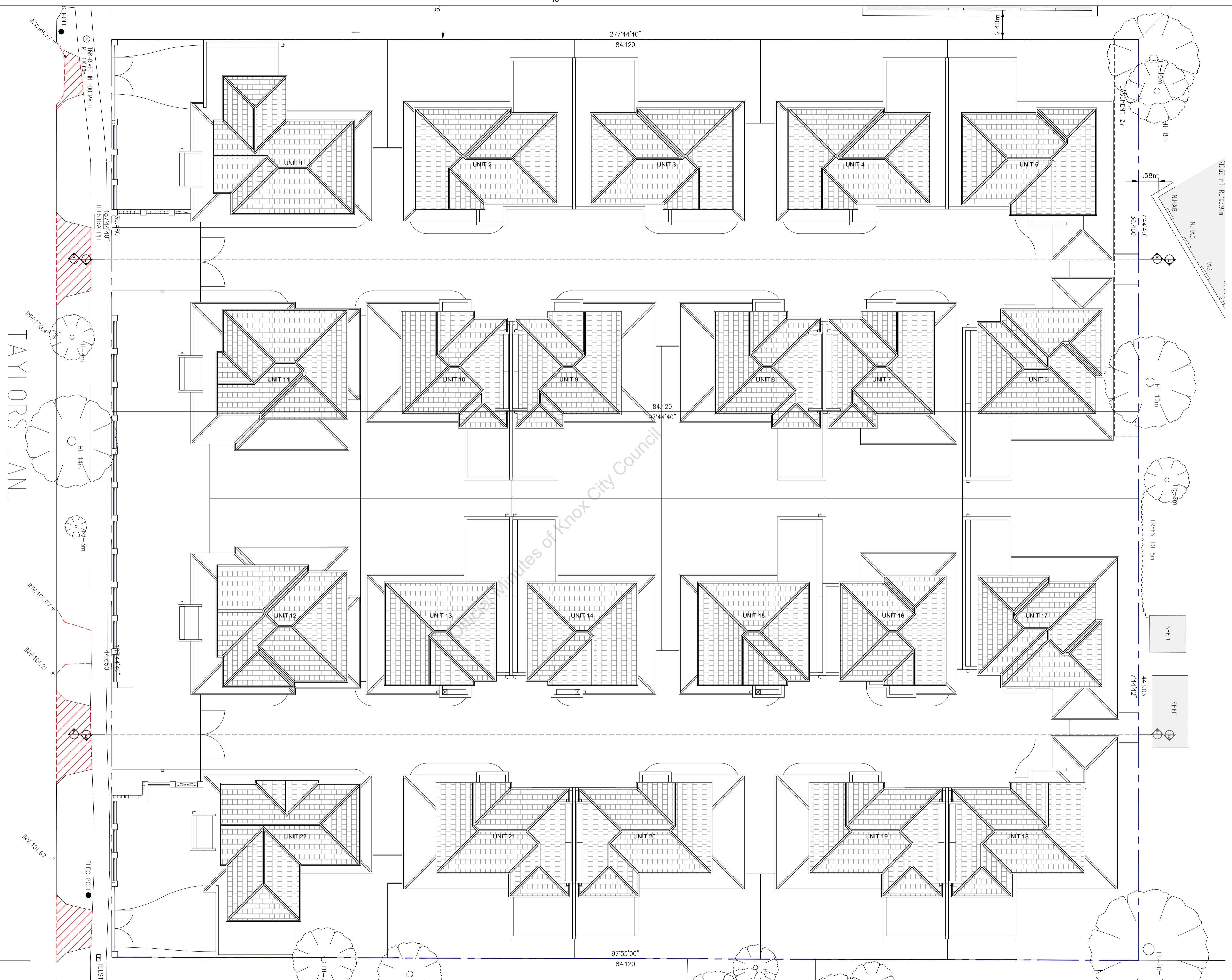

TAYLORS LANE

APPENDIX B 24-26 TAYLORS LANE ROWVILLE

FIRST FLOOR PLAN
SCALE 1:150 @ A1

Notes

- DO NOT SCALE FROM DRAWINGS.
- SITE & FLOOR LEVELS TO BE CONFIRMED ON SITE BY BUILDER PRIOR TO COMMENCEMENT OF ANY WORKS. ANY ERRORS, DISCREPANCIES OR OMISSIONS IN THE DRAWINGS, NOTATIONS OR DIMENSIONS SHALL BE IMMEDIATELY BROUGHT TO THE ATTENTION OF THE ARCHITECT FOR CLARIFICATION PRIOR TO WORKS COMMENCING.
- ARCHITECTURAL DRAWINGS TO BE READ IN CONJUNCTION WITH SPECIFICATIONS, STRUCTURAL, MECHANICAL, ELECTRICAL, HYDRAULIC, LANDSCAPE ARCHITECTURAL DRAWINGS. LOCATION OF ALL HARDWARE, FIXTURES AND FITTINGS TO BE CONFIRMED WITH ARCHITECT PRIOR TO WORKS COMMENCING.

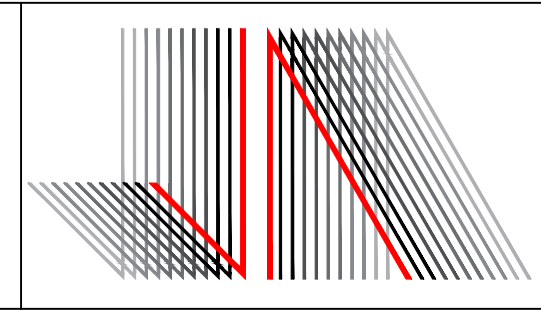

JESSE ANT ARCHITECTS
6 / 1153-1157 Burke Road, Kew VIC 3101
Ph: (03) 9817 6788
Email: info@jesseantarchitects.com.au; www.jesseantarchitects.com.au
ABN: 29 469 352 797

Project	24-26 TAYLORS LANE, ROWVILLE
Drawing	ROOF PLAN

Date	Rev	Description
26.04.17	A	TP Submission
07.07.17	B	Response to RFI

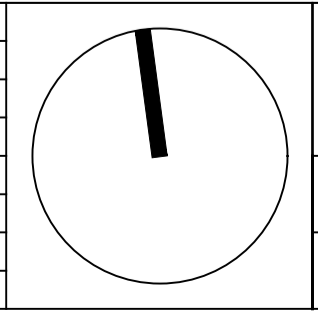

Project Number		15031		Drawing Number	TP08
Date	07-07-2017	Scale	1:150	Amendment	B
Drawn	YZ	Checked	AL/JW		

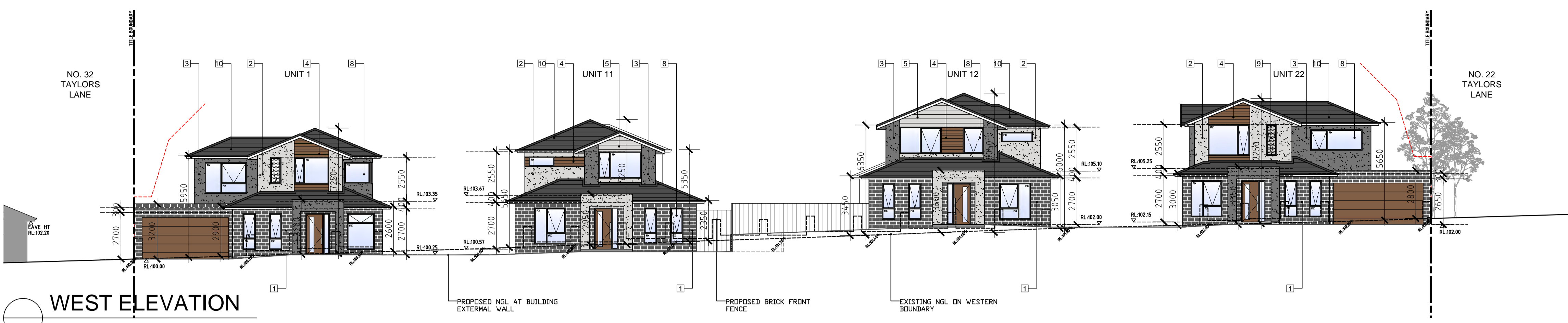

WEST ELEVATION
SCALE 1:150 @ A1

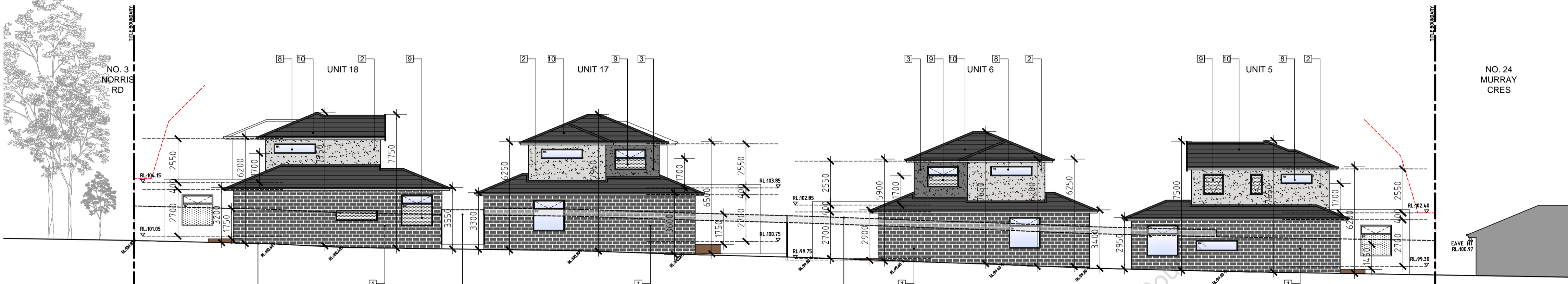

EAST ELEVATION
SCALE 1:150 @ A1

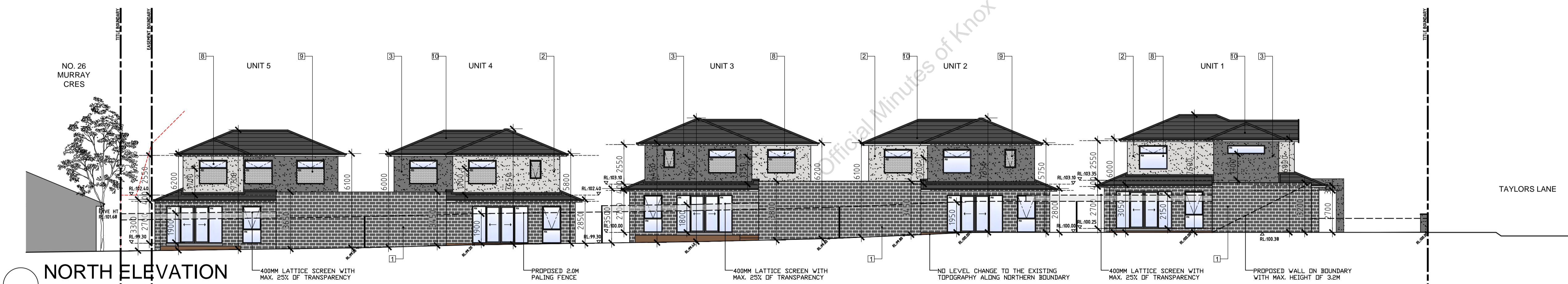

NORTH ELEVATION
SCALE 1:150 @ A1

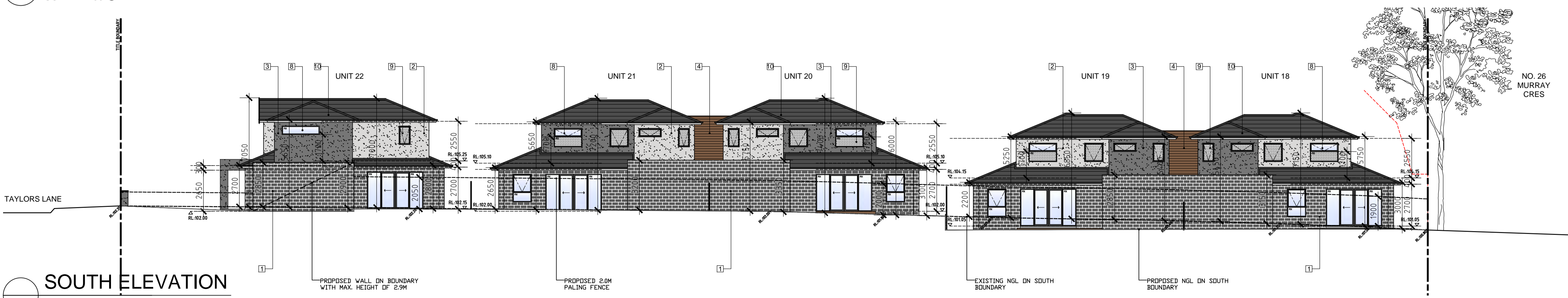

SOUTH ELEVATION
SCALE 1:150 @ A1

MATERIAL SCHEDULE:

	1 SELECTED FACED BRICK
	2 SELECTED RENDER 1
	3 SELECTED RENDER 2
	4 SELECTED TIMBER LOOK CLADDING
	5 SELECTED HORIZONTAL CLADDING
	6 SELECTED ALUMINIUM SECTIONAL GARAGE DOOR
	7 SELECTED TIMBER LOOK SECTIONAL GARAGE DOOR
	8 CLEAR GLAZING
	9 FIXED OBSCURE GLAZING
	10 SELECTED CONCRETE ROOF TILE

Notes
- DO NOT SCALE FROM DRAWINGS.
- SITE & FLOOR LEVELS TO BE CONFIRMED ON SITE BY BUILDER PRIOR TO COMMENCEMENT OF ANY WORKS. ANY ERRORS, DISCREPANCIES OR OMISSIONS IN THE DRAWINGS, NOTATIONS OR DIMENSIONS SHALL BE IMMEDIATELY BROUGHT TO THE ATTENTION OF THE ARCHITECT FOR CLARIFICATION PRIOR TO WORKS COMMENCING.
- ARCHITECTURAL DRAWINGS TO BE READ IN CONJUNCTION WITH SPECIFICATIONS, STRUCTURAL, MECHANICAL, ELECTRICAL, HYDRAULIC, LANDSCAPE ARCHITECTURAL DRAWINGS. LOCATION OF ALL HARDWARE, FIXTURES AND FITTINGS TO BE CONFIRMED WITH ARCHITECT PRIOR TO WORKS COMMENCING.

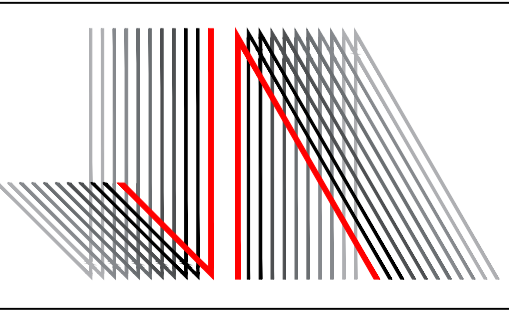

JESSE ANT ARCHITECTS
6 / 1153-1157 Burke Road , Kew VIC 3101
Ph: (03) 9817 6788
Email: info@jesseantarchitects.com.au; www.jesseantarchitects.com.au
ABN: 29 469 352 797

Project	24-26 TAYLORS LANE, ROWVILLE
Drawing	ELEVATIONS

Date	Rev	Description
26.04.17	A	TP Submission
07.07.17	B	Response to RFI

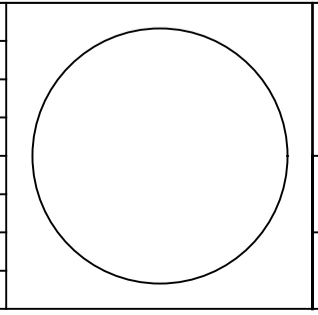

Project Number	15031		Drawing Number	TP09
Date	07-07-2017	Scale	1:150	Amendment
Drawn	YZ	Checked	AL/JW	B

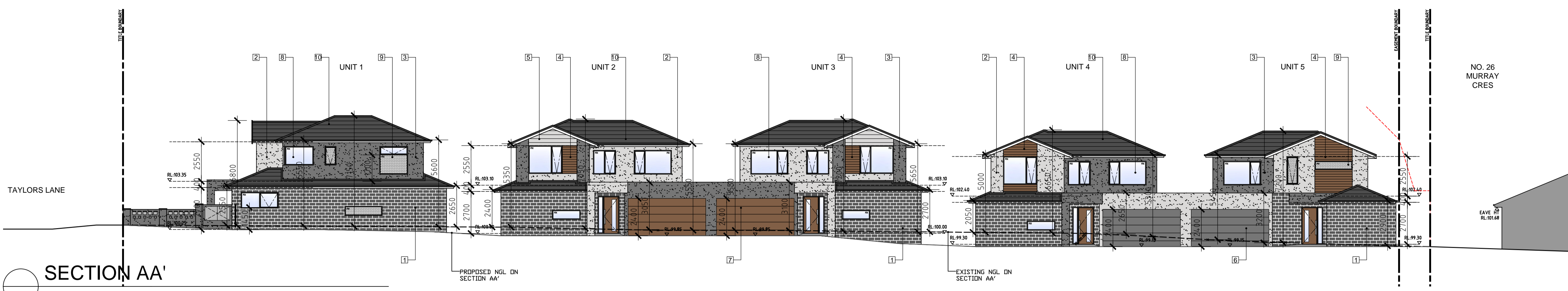

SECTION AA'
SCALE 1:150 @ A1

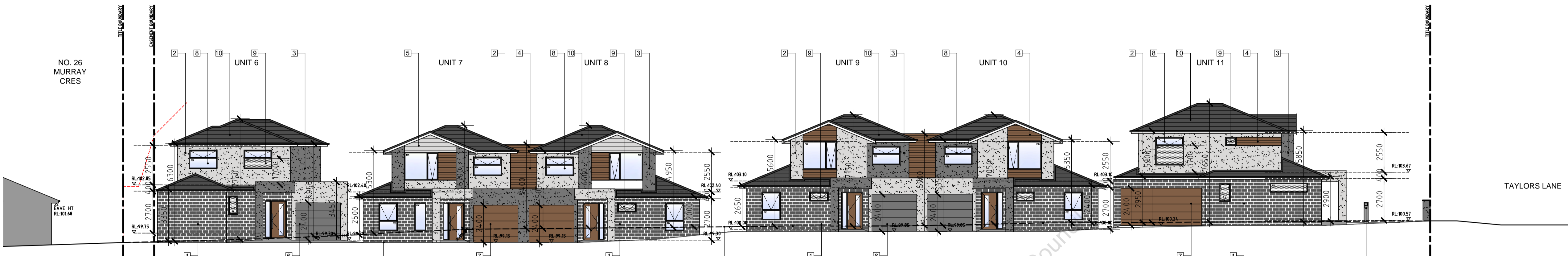

SECTION BB'
SCALE 1:150 @ A1

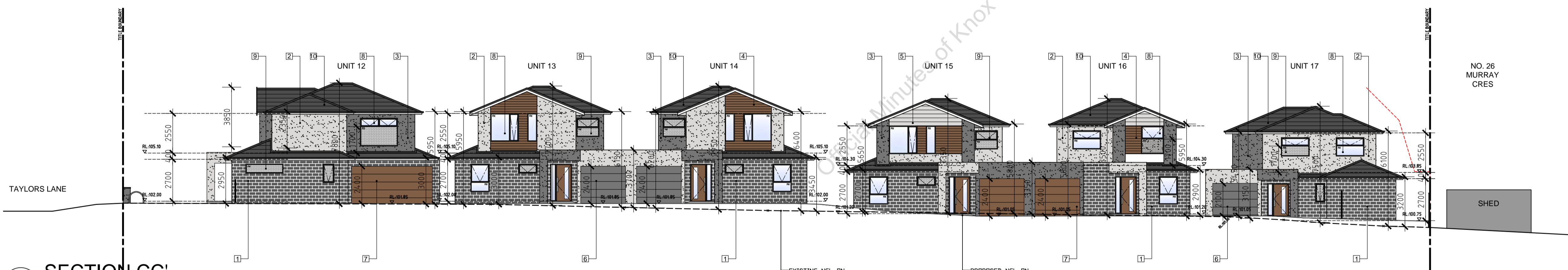

SECTION CC'
SCALE 1:150 @ A1

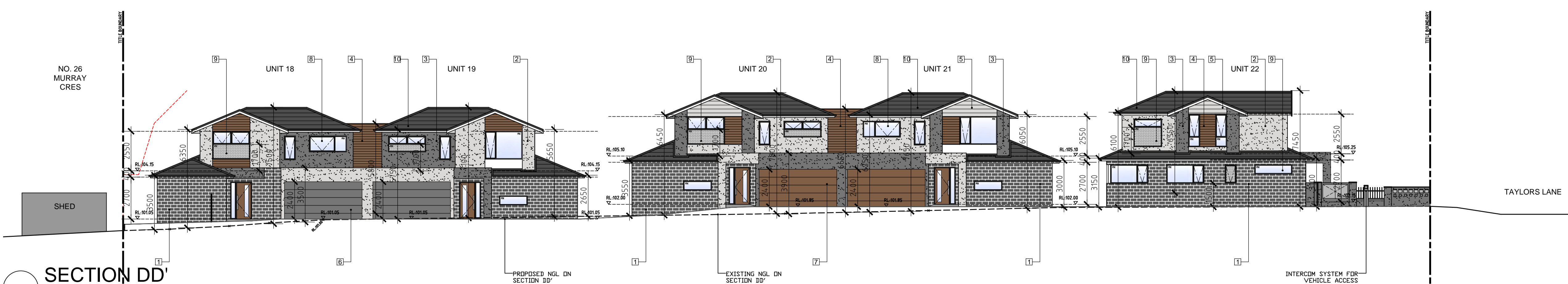

SECTION DD'
SCALE 1:150 @ A1

MATERIAL SCHEDULE:

	1 SELECTED FACED BRICK
	2 SELECTED RENDER 1
	3 SELECTED RENDER 2
	4 SELECTED TIMBER LOOK CLADDING
	5 SELECTED HORIZONTAL CLADDING
	6 SELECTED ALUMINIUM SECTIONAL GARAGE DOOR
	7 SELECTED TIMBER LOOK SECTIONAL GARAGE DOOR
	8 CLEAR GLAZING
	9 FIXED OBSCURE GLAZING
	10 SELECTED CONCRETE ROOF TILE

Notes

- DO NOT SCALE FROM DRAWINGS.
- SITE & FLOOR LEVELS TO BE CONFIRMED ON SITE BY BUILDER PRIOR TO COMMENCEMENT OF ANY WORKS. ANY ERRORS, DISCREPANCIES OR OMISSIONS IN THE DRAWINGS, NOTATIONS OR DIMENSIONS SHALL BE IMMEDIATELY BROUGHT TO THE ATTENTION OF THE ARCHITECT FOR CLARIFICATION PRIOR TO WORKS COMMENCING.
- ARCHITECTURAL DRAWINGS TO BE READ IN CONJUNCTION WITH SPECIFICATIONS, STRUCTURAL, MECHANICAL, ELECTRICAL, HYDRAULIC, LANDSCAPE ARCHITECTURAL DRAWINGS. LOCATION OF ALL HARDWARE, FIXTURES AND FITTINGS TO BE CONFIRMED WITH ARCHITECT PRIOR TO WORKS COMMENCING.

JESSE ANT ARCHITECTS
 6 / 1153-1157 Burke Road , Kew VIC 3101
 Ph: (03) 9817 6788
 Email: info@jesseantarchitects.com.au; www.jesseantarchitects.com.au
 ABN: 29 469 352 797

Project	24-26 TAYLORS LANE, ROWVILLE
Drawing	INTERNAL ELEVATIONS

Date	Rev	Description
26.04.17	A	TP Submission
07.07.17	B	Response to RFI

Project Number	15031		Drawing Number	TP10
Date	07-07-2017	Scale	1:150	Amendment
Drawn	YZ	Checked	AL/JW	B

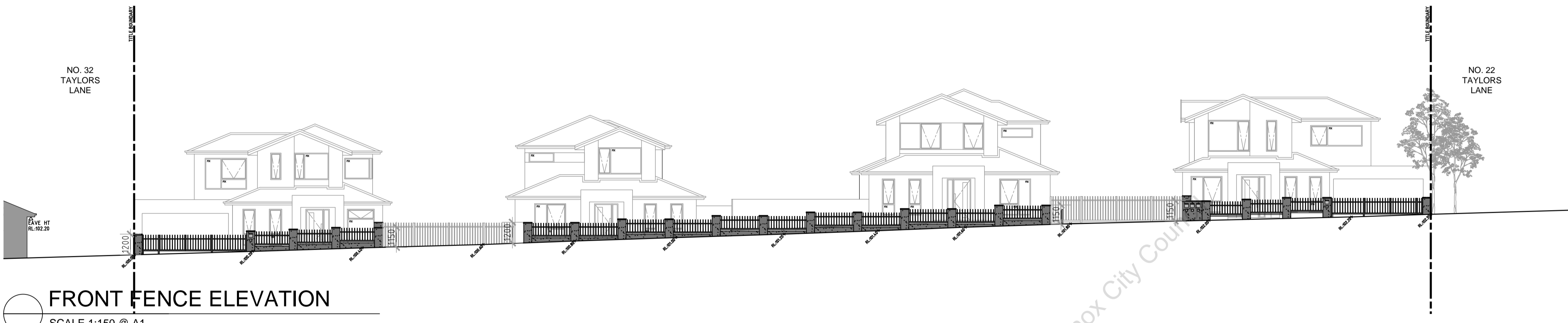

FRONT FENCE ELEVATION
SCALE 1:150 @ A1

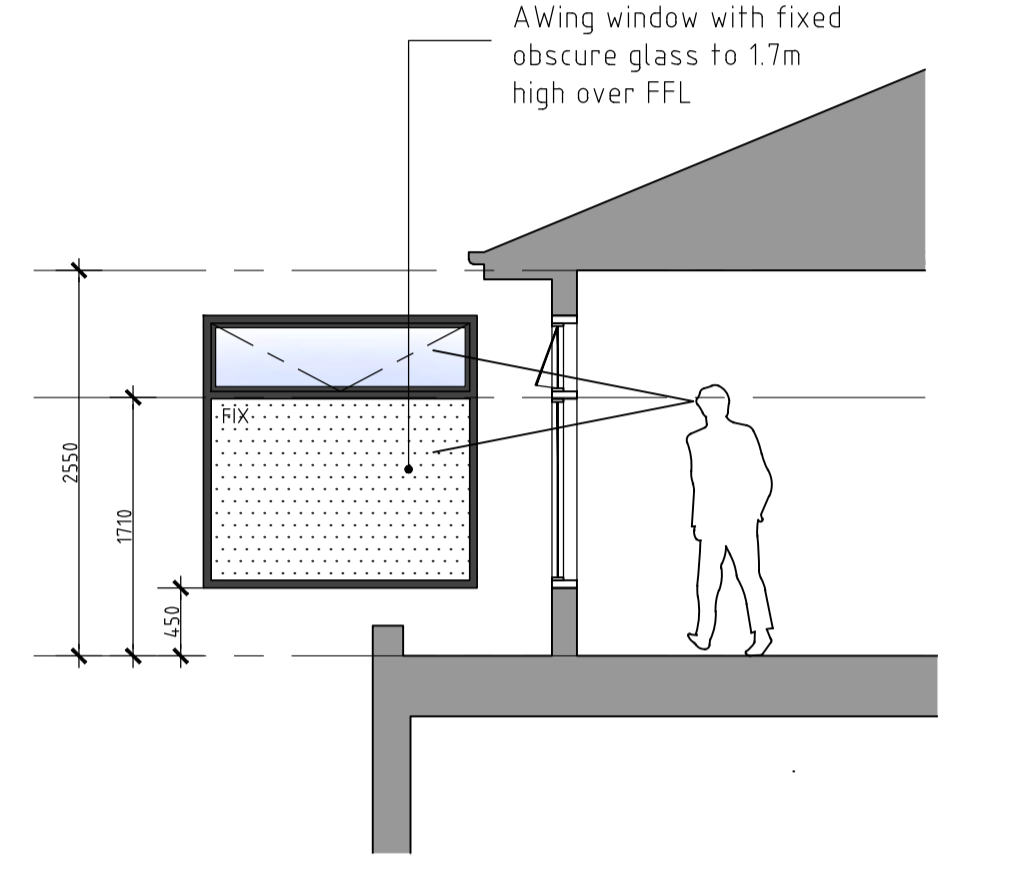
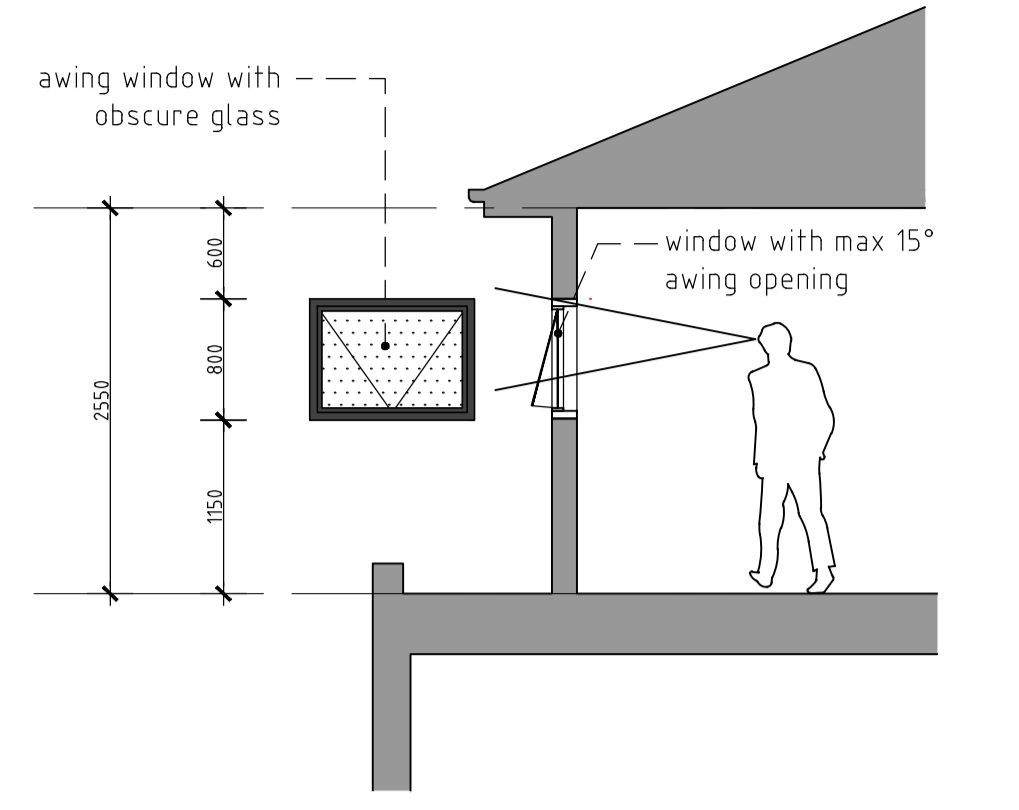

OVERLOOKING DIAGRAM
SCALE 1:50 @ A1

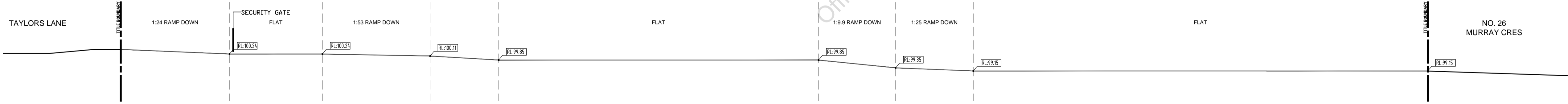

DRIVEWAY RAMP SECTION AA'
SCALE 1:150 @ A1

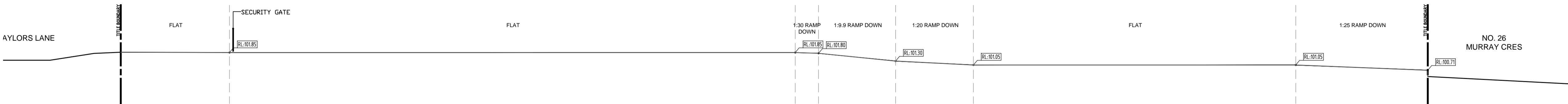

DRIVEWAY RAMP SECTION CC'
SCALE 1:150 @ A1

Notes
- DO NOT SCALE FROM DRAWINGS.
- SITE & FLOOR LEVELS TO BE CONFIRMED ON SITE BY BUILDER PRIOR TO COMMENCEMENT OF ANY WORKS. ANY ERRORS, DISCREPANCIES OR OMISSIONS IN THE DRAWINGS, NOTATIONS OR DIMENSIONS SHALL BE IMMEDIATELY BROUGHT TO THE ATTENTION OF THE ARCHITECT FOR CLARIFICATION PRIOR TO WORKS COMMENCING.
- ARCHITECTURAL DRAWINGS TO BE READ IN CONJUNCTION WITH SPECIFICATIONS.
- STRUCTURAL, MECHANICAL, ELECTRICAL, HYDRAULIC, LANDSCAPE ARCHITECTURAL DRAWINGS. LOCATION OF ALL HARDWARE, FIXTURES AND FITTINGS TO BE CONFIRMED WITH ARCHITECT PRIOR TO WORKS COMMENCING.

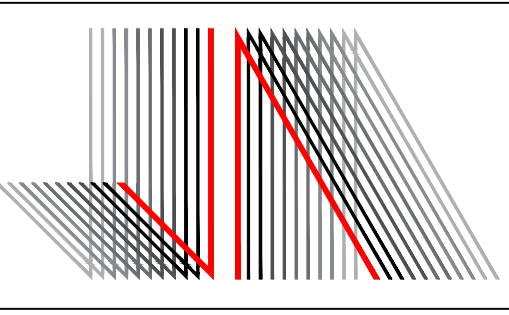

JESSE ANT ARCHITECTS
6 / 1153-1157 Burke Road , Kew VIC 3101
Ph: (03) 9817 6788
Email: info@jesseantarchitects.com.au; www.jesseantarchitects.com.au
ABN: 29 469 352 797

Project	Date	Rev	Description
24-26 TAYLORS LANE, ROWVILLE	26.04.17	A	TP Submission
	07.07.17	B	Response to RFI
Drawing			
FRONT FENCE ELEVATION & RAMP SECTIONS			

Project Number	Drawing Number
15031	TP11
Date	Scale
07-07-2017	
Drawn	Checked
YZ	AL /JW

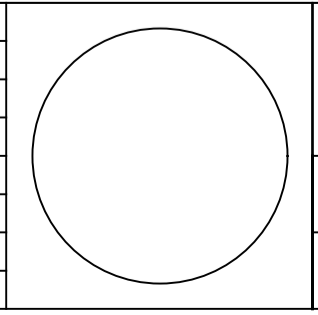

Project Number	Drawing Number
15031	TP11
Date	Scale
07-07-2017	
Drawn	Checked
YZ	AL /JW

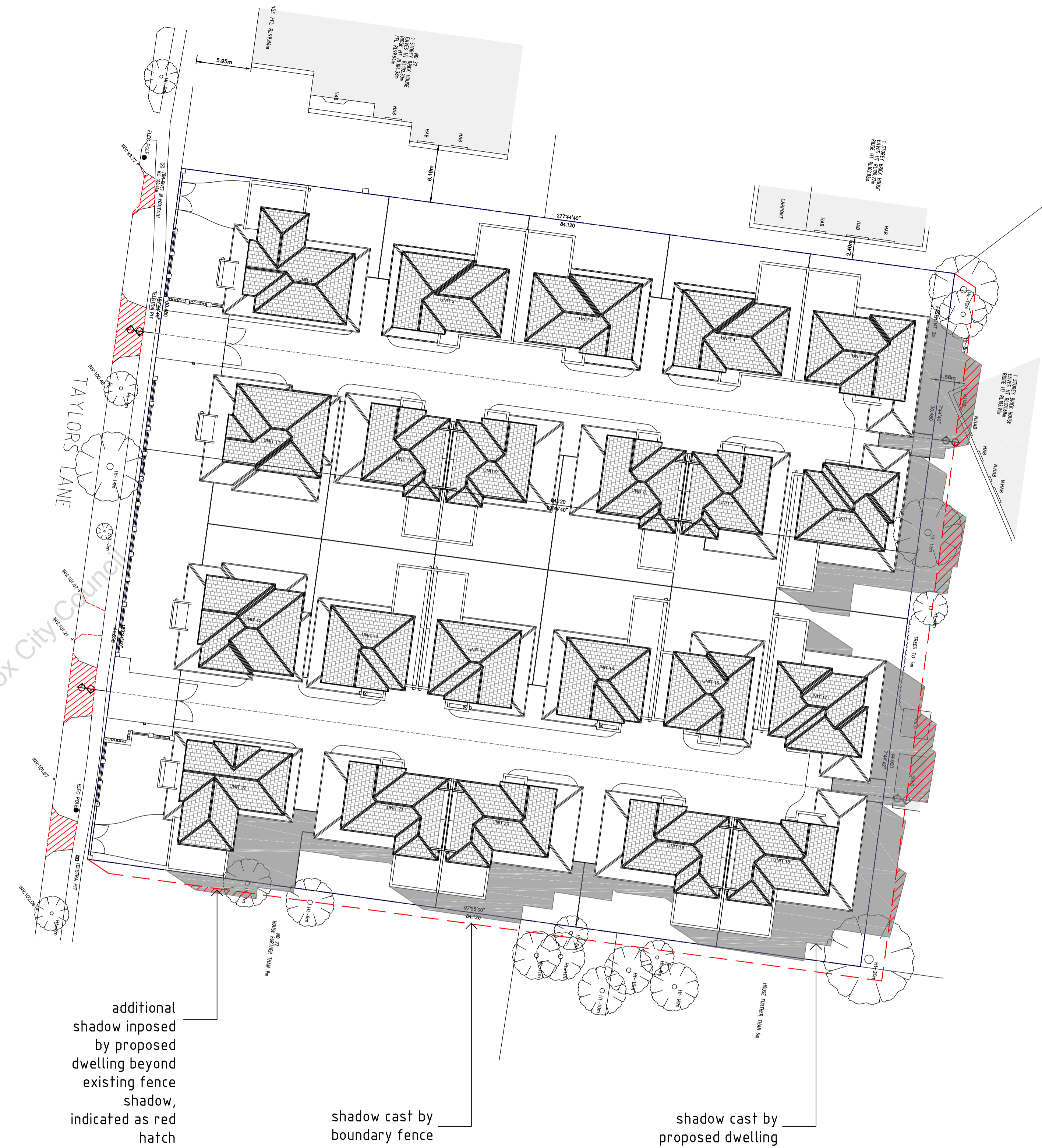
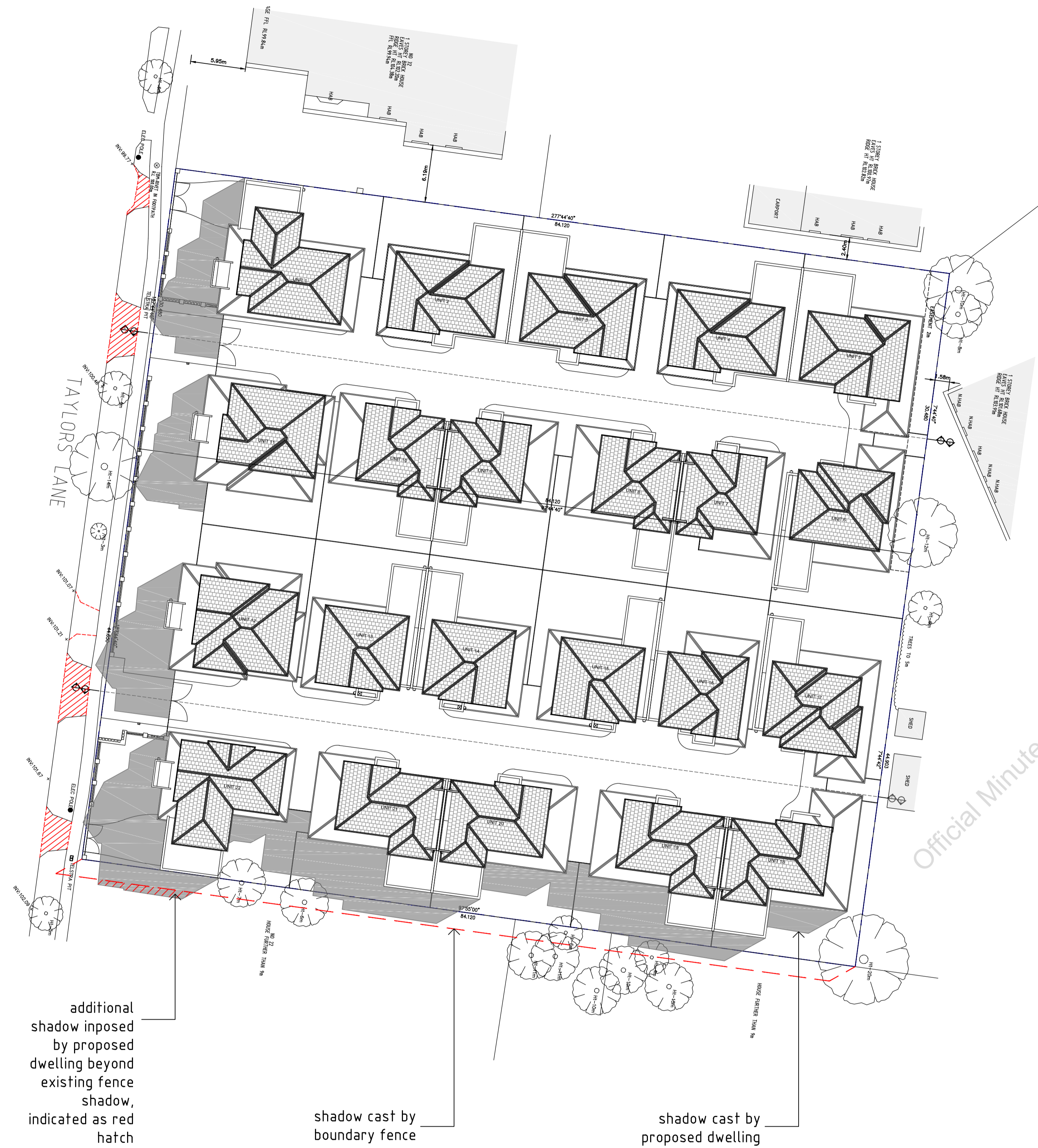

SHADOW DIAGRAM SEP 22 9AM
SCALE 1:300 @ A1

SHADOW DIAGRAM SEP 22 12PM
SCALE 1:300 @ A1

APPENDIX B 24-26 TAYLORS LANE ROWVILLE

Notes
 - DO NOT SCALE FROM DRAWINGS.
 - SITE & FLOOR LEVELS TO BE CONFIRMED ON SITE BY BUILDER PRIOR TO COMMENCEMENT OF ANY WORKS. ANY ERRORS, DISCREPANCIES OR OMISSIONS IN THE DRAWINGS, NOTATIONS OR DIMENSIONS SHALL BE IMMEDIATELY BROUGHT TO THE ATTENTION OF THE ARCHITECT FOR CLARIFICATION PRIOR TO WORKS COMMENCING.
 - ARCHITECTURAL DRAWINGS TO BE READ IN CONJUNCTION WITH SPECIFICATIONS, STRUCTURAL, MECHANICAL, ELECTRICAL, HYDRAULIC, LANDSCAPE ARCHITECTURAL DRAWINGS. LOCATION OF ALL HARDWARE, FIXTURES AND FITTINGS TO BE CONFIRMED WITH ARCHITECT PRIOR TO WORKS COMMENCING.

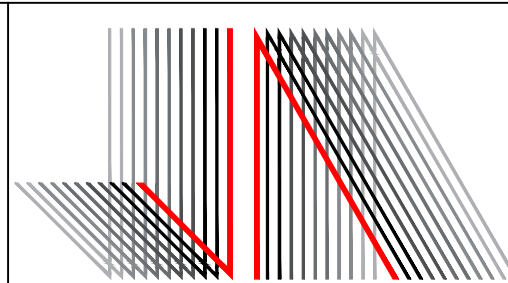

JESSE ANT ARCHITECTS
 6 / 1153-1157 Burke Road , Kew VIC 3101
 Ph: (03) 9817 6788
 Email: info@jesseantarchitects.com.au; www.jesseantarchitects.com.au
 ABN: 29 469 352 797

Project	24-26 TAYLORS LANE, ROWVILLE
Drawing	SHADOW DIAGRAMS

Date	Rev	Description
26.04.17	A	TP Submission
07.07.17	B	Response to RFI

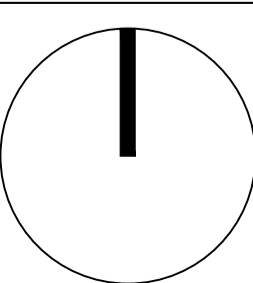

Project Number		15031		Drawing Number	TP12
Date	07-07-2017	Scale	1:300	Amendment	B
Drawn	YZ	Checked	AL/JW		

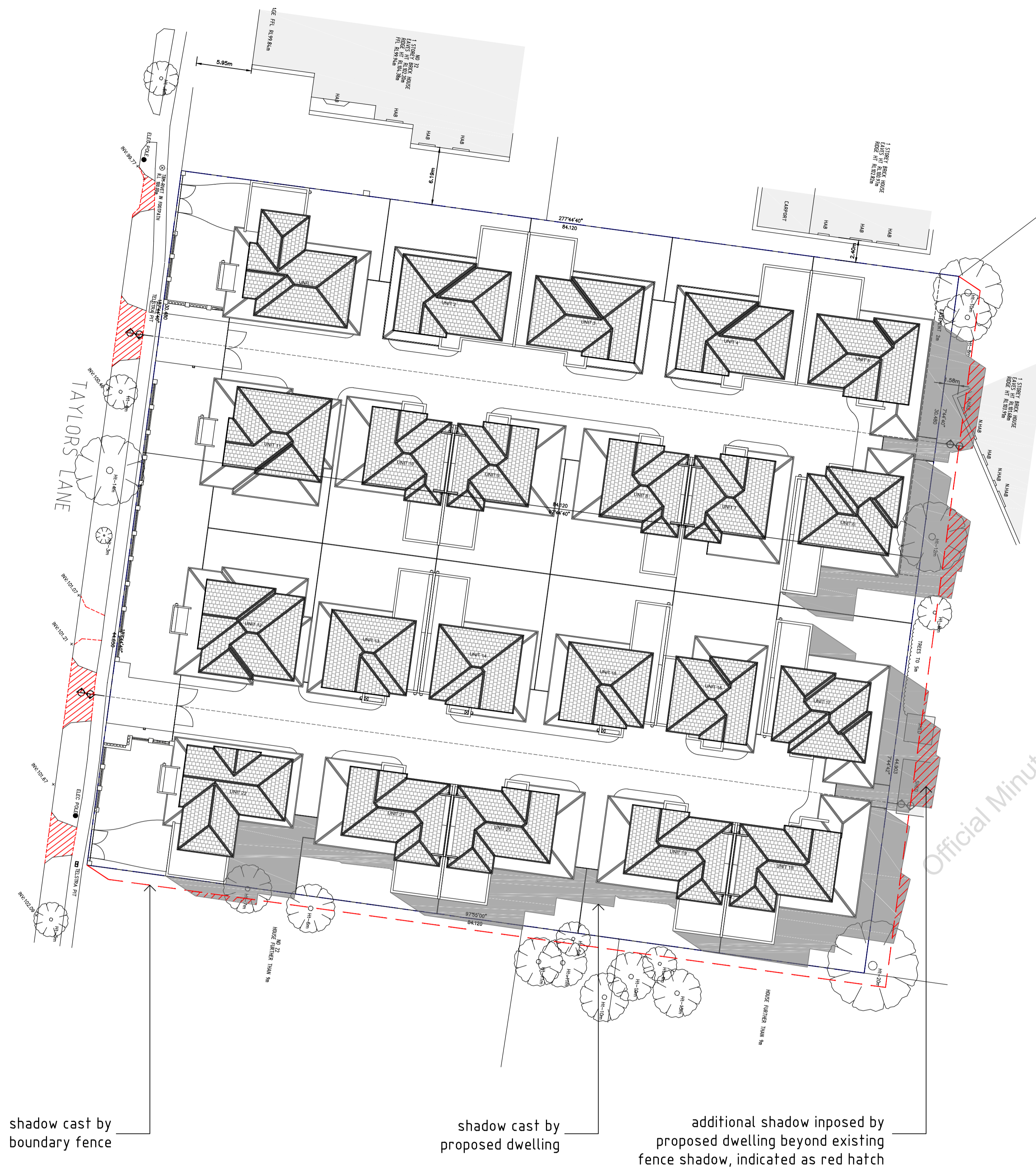

Official Minutes of Knox City Council

SHADOW DIAGRAM SEP 22 3PM
SCALE 1:300 @ A1

APPENDIX B 24-26 TAYLORS LANE ROWVILLE

Notes
 - DO NOT SCALE FROM DRAWINGS.
 - SITE & FLOOR LEVELS TO BE CONFIRMED ON SITE BY BUILDER PRIOR TO COMMENCEMENT OF ANY WORKS. ANY ERRORS, DISCREPANCIES OR OMISSIONS IN THE DRAWINGS, NOTATIONS OR DIMENSIONS SHALL BE IMMEDIATELY BROUGHT TO THE ATTENTION OF THE ARCHITECT FOR CLARIFICATION PRIOR TO WORKS COMMENCING.
 - ARCHITECTURAL DRAWINGS TO BE READ IN CONJUNCTION WITH SPECIFICATIONS, STRUCTURAL, MECHANICAL, ELECTRICAL, HYDRAULIC, LANDSCAPE ARCHITECTURAL DRAWINGS. LOCATION OF ALL HARDWARE, FIXTURES AND FITTINGS TO BE CONFIRMED WITH ARCHITECT PRIOR TO WORKS COMMENCING.

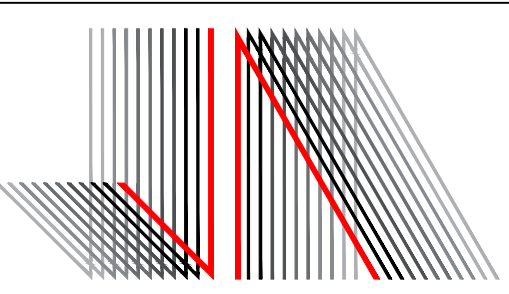

JESSE ANT ARCHITECTS
 6 / 1153-1157 Burke Road , Kew VIC 3101
 Ph: (03) 9817 6788
 Email: info@jesseantarchitects.com.au; www.jesseantarchitects.com.au
 ABN: 29 469 352 797

Project	24-26 TAYLORS LANE, ROWVILLE
Drawing	SHADOW DIAGRAMS

Date	Rev	Description
26.04.17	A	TP Submission
07.07.17	B	Response to RFI

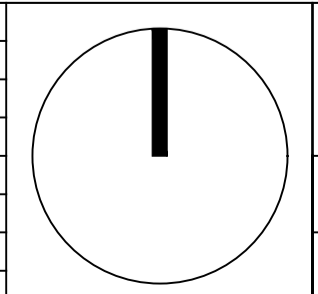

Project Number		15031		Drawing Number	TP13
Date	07-07-2017	Scale	1:300	Amendment	B
Drawn	YZ	Checked	AL/JW		



SITE PLAN
SCALE 1:200 @ A1

Development Summary:	
Total Site Area:	6330.6m ²
Total Site Coverage:	2865.9m ² (45%)
Total Permeable Area:	2540.0m ² (40%)
Total Garden Area:	2538.9m ² (40%)
Driveway & visitor parking:	933.4m ²

Unit	Site Coverage	Ground Floor Area	First Floor Area	SPOS > 5m	Total POS	No. of Bed	No. of Car Space	Storage
Unit 1	153.3m ²	148.5m ²	84.8m ²	60.0m ²	136.9m ²	4	2	6m ³
Unit 2	111.9m ²	110.0m ²	60.0m ²	61.8m ²	84.5m ²	3	2	6m ³
Unit 3	111.9m ²	110.0m ²	60.0m ²	61.8m ²	84.5m ²	3	2	6m ³
Unit 4	136.2m ²	134.4m ²	73.0m ²	64.9m ²	80.7m ²	4	2	6m ³
Unit 5	201.8m ²	198.4m ²	117.2m ²	67.6m ²	119.9m ²	3	2	6m ³
Unit 6	202.5m ²	199.4m ²	-	67.9m ²	117.2m ²	3	2	6m ³
Unit 7	116.7m ²	114.7m ²	61.8m ²	71.8m ²	83.1m ²	3	2	6m ³
Unit 8	137.3m ²	135.4m ²	75.2m ²	72.4m ²	89.6m ²	4	2	6m ³
Unit 9	137.3m ²	135.4m ²	75.2m ²	72.4m ²	89.6m ²	4	2	6m ³
Unit 10	137.3m ²	132.5m ²	74.5m ²	73.5m ²	184.5m ²	4	2	6m ³
Unit 11	137.3m ²	137.3m ²	82.6m ²	66.9m ²	220.8m ²	4	2	6m ³
Unit 12	136.2m ²	134.4m ²	73.8m ²	61.9m ²	81.3m ²	4	2	6m ³
Unit 13	136.2m ²	134.4m ²	73.8m ²	61.9m ²	81.3m ²	4	2	6m ³
Unit 14	115.3m ²	113.4m ²	61.1m ²	70.3m ²	81.6m ²	3	2	6m ³
Unit 15	201.8m ²	198.4m ²	117.2m ²	67.6m ²	116.6m ²	3	2	6m ³
Unit 16	202.5m ²	199.4m ²	-	65.1m ²	114.4m ²	3	2	6m ³
Unit 17	136.2m ²	134.4m ²	73.0m ²	65.9m ²	82.4m ²	4	2	6m ³
Unit 18	111.9m ²	110.0m ²	60.0m ²	61.8m ²	85.9m ²	3	2	6m ³
Unit 19	111.9m ²	110.0m ²	60.0m ²	61.8m ²	85.9m ²	3	2	6m ³
Unit 20	130.7m ²	125.9m ²	85.2m ²	62.9m ²	229.9m ²	4	2	6m ³

Notes
 - DO NOT SCALE FROM DRAWINGS.
 - SITE & FLOOR LEVELS TO BE CONFIRMED ON SITE BY BUILDER PRIOR TO COMMENCEMENT OF ANY WORKS. ANY ERRORS, DISCREPANCIES OR OMISSIONS IN THE DRAWINGS, NOTATIONS OR DIMENSIONS SHALL BE IMMEDIATELY BROUGHT TO THE ATTENTION OF THE ARCHITECT FOR CLARIFICATION PRIOR TO WORKS COMMENCING.
 - ARCHITECTURAL DRAWINGS TO BE READ IN CONJUNCTION WITH SPECIFICATIONS, STRUCTURAL, MECHANICAL, ELECTRICAL, HYDRAULIC, LANDSCAPE ARCHITECTURAL DRAWINGS.
 - LOCATION OF ALL HARDWARE, FIXTURES AND FITTINGS TO BE CONFIRMED WITH ARCHITECT PRIOR TO WORKS COMMENCING.

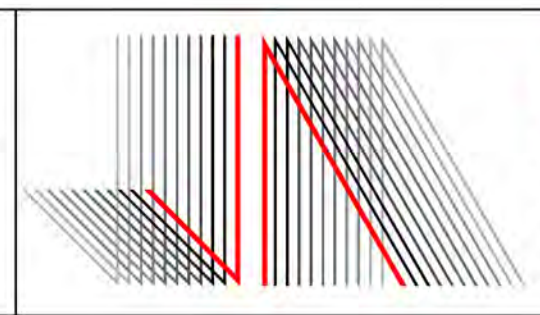

JESSE ANT ARCHITECTS
 6 / 1153-1157 Burke Road , Kew VIC 3101
 Ph: (03) 9817 6788
 Email: info@jesseantarchitects.com.au; www.jesseantarchitects.com.au
 ABN: 29 469 352 797

Project
24-26 TAYLORS LANE, ROWVILLE

Drawing
SITE PLAN

Date	Rev	Description

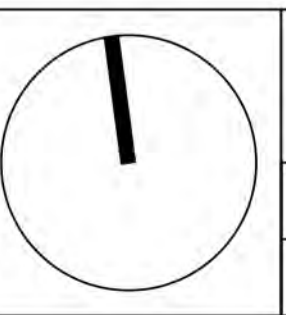

Project Number
15031

Date 26-02-2018 Scale 1:200

Drawn YZ Checked AL/JW

Drawing Number
TPO5

Amendment
D

APPENDIX C 24-26 TAYLORS LANE ROWVILLE



LEGEND

- DENOTES TREE IDENTIFICATION NUMBER MENTIONED IN ARBORIST REPORT
- DENOTE TREE PROTECTION ZONE & STRUCTURE ROOT ZONE
- DENOTE AREA OF STRUCTURE ENCROACH INTO THE TREE PROTECTION ZONE
- DENOTE EXISTING TREES OR SHRUBS TO BE REMOVED
- DENOTE PROPOSED INDIGENOUS CANOPY TREE
- DENOTES LAWN, GARDEN BED AND EXTERNAL PERVIOUS SOFTSCAPED AREAS.
- DENOTE SELECTED CONCRETE DRIVEWAY
- DENOTE SELECTED PAVED AREA TO BE LAND ON POROUS COMPACTED SAND BASE
- DENOTE SELECTED STEPPING STONES
- DENOTE SPACE TIMBER DECKING WITH PERMEABLE SOIL AREA UNDERNEATH
- DENOTE SELECTED PERMEABLE DRIVEWAY
- DENOTES 6 CUBIC METRES OF STORAGE SHED
- DENOTE SELECTED CLOTHESLINE LOCATION
- DENOTE SELECTED MAIL BOX LOCATION
- DENOTE SELECTED ELECTRICITY METER BOX LOCATION
- DENOTE 3000L S-LINE RAINWATER TANK

NOTE:

- THE ROOF AREAS FOR EACH DWELLINGS WILL BE CONNECTED TO EACH RAINWATER TANKS.
- ALL TOILETS WILL BE CONNECTED TO THE RAINWATER TANKS.
- ALL INTERNAL FENCES ARE TIMBER PAILING FENCE TO 1.8M HIGH ABOVE PROPOSED GROUND LEVEL/RETAINING WALL

GROUND FLOOR PLAN
SCALE 1:200 @ A1

Notes

- DO NOT SCALE FROM DRAWINGS.
- SITE & FLOOR LEVELS TO BE CONFIRMED ON SITE BY BUILDER PRIOR TO COMMENCEMENT OF ANY WORKS. ANY ERRORS, DISCREPANCIES OR OMISSIONS IN THE DRAWINGS, NOTATIONS OR DIMENSIONS SHALL BE IMMEDIATELY BROUGHT TO THE ATTENTION OF THE ARCHITECT FOR CLARIFICATION PRIOR TO WORKS COMMENCING.
- ARCHITECTURAL DRAWINGS TO BE READ IN CONJUNCTION WITH SPECIFICATIONS, STRUCTURAL, MECHANICAL, ELECTRICAL, HYDRAULIC, LANDSCAPE ARCHITECTURAL DRAWINGS.
- LOCATION OF ALL HARDWARE, FIXTURES AND FITTINGS TO BE CONFIRMED WITH ARCHITECT PRIOR TO WORKS COMMENCING.

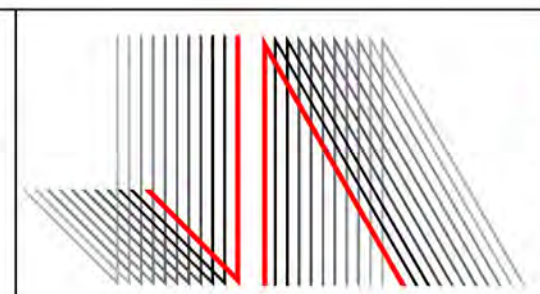

JESSE ANT ARCHITECTS
6 / 1153-1157 Burke Road , Kew VIC 3101
Ph: (03) 9817 6788
Email: info@jessantarchitects.com.au; www.jessantarchitects.com.au
ABN: 29 469 352 797

Project
24-26 TAYLORS LANE, ROWVILLE

Drawing
GROUND FLOOR PLAN

Date	Rev	Description



Project Number 15031		Drawing Number TPO6	
Date 26-02-2018	Scale 1:200	Drawn YZ	Checked AL/JW
Amendment D			

APPENDIX C 24-26 TAYLORS LANE ROWVILLE



FIRST FLOOR PLAN
SCALE 1:200 @ A1

Notes

- DO NOT SCALE FROM DRAWINGS.
- SITE & FLOOR LEVELS TO BE CONFIRMED ON SITE BY BUILDER PRIOR TO COMMENCEMENT OF ANY WORKS. ANY ERRORS, DISCREPANCIES OR OMISSIONS IN THE DRAWINGS, NOTATIONS OR DIMENSIONS SHALL BE IMMEDIATELY BROUGHT TO THE ATTENTION OF THE ARCHITECT FOR CLARIFICATION PRIOR TO WORKS COMMENCING.
- ARCHITECTURAL DRAWINGS TO BE READ IN CONJUNCTION WITH SPECIFICATIONS, STRUCTURAL, MECHANICAL, ELECTRICAL, HYDRAULIC, LANDSCAPE ARCHITECTURAL DRAWINGS. LOCATION OF ALL HARDWARE, FIXTURES AND FITTINGS TO BE CONFIRMED WITH ARCHITECT PRIOR TO WORKS COMMENCING.

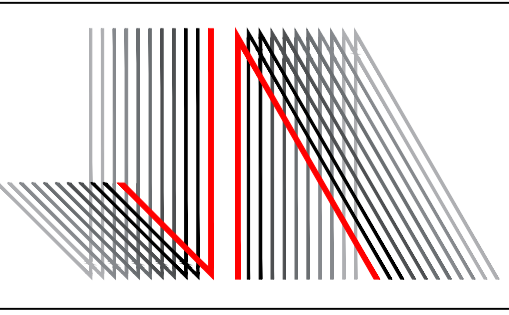

JESSE ANT ARCHITECTS
6 / 1153-1157 Burke Road , Kew VIC 3101
Ph: (03) 9817 6788
Email: info@jesseantarchitects.com.au; www.jesseantarchitects.com.au
ABN: 29 469 352 797

Project
24-26 TAYLORS LANE, ROWVILLE

Drawing
FIRST FLOOR PLAN

Date	Rev	Description

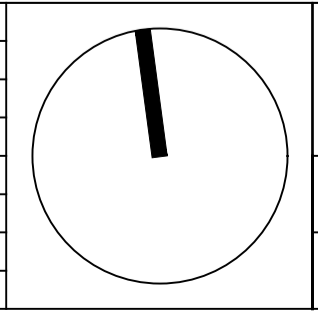

Project Number 15031		Drawing Number TP07	
Date 26-02-2018	Scale 1:200	Amendment D	
Drawn YZ	Checked AL/JW		

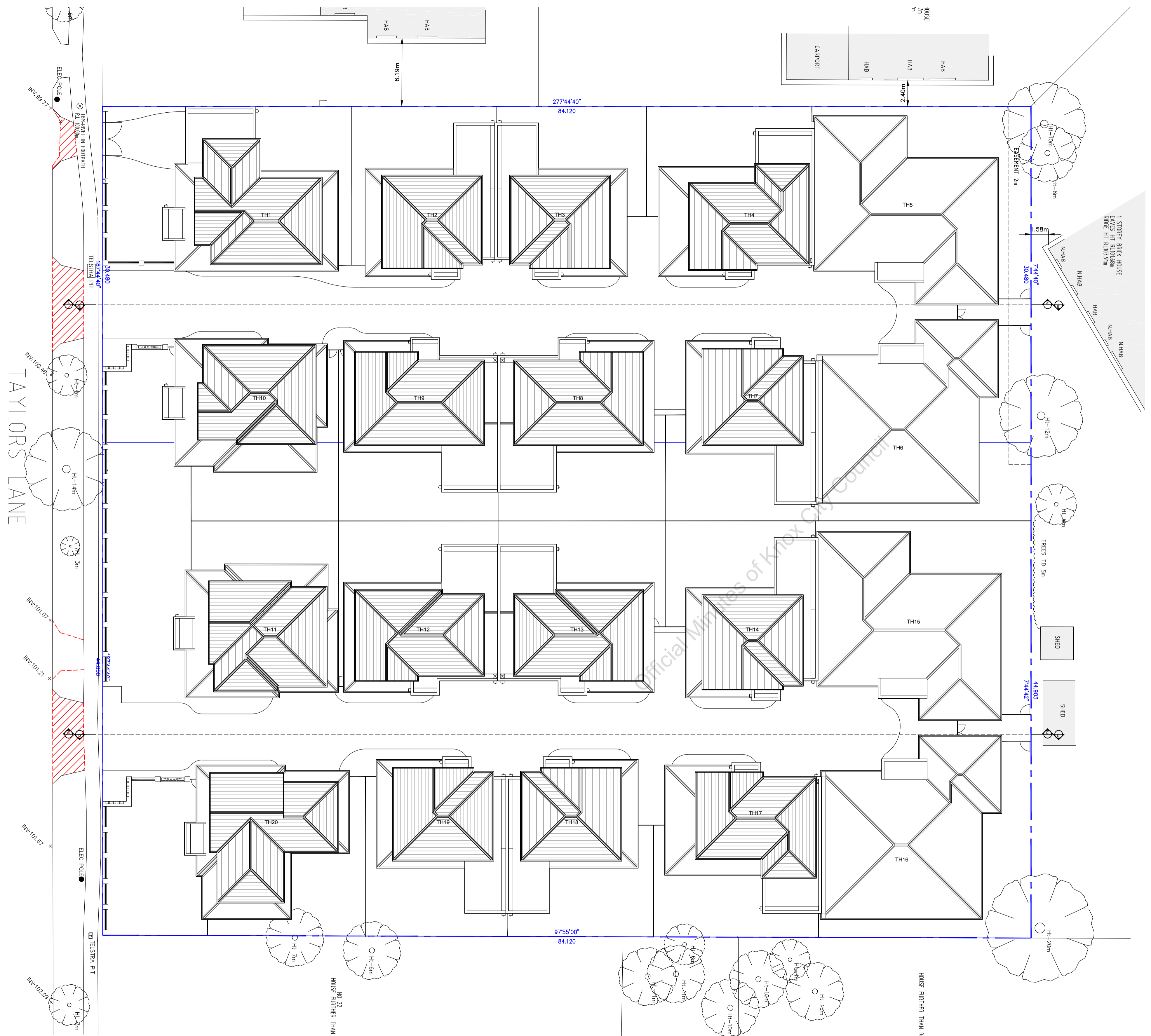

ROOF PLAN
SCALE 1:200 @ A1

Notes
 - DO NOT SCALE FROM DRAWINGS.
 - SITE & FLOOR LEVELS TO BE CONFIRMED ON SITE BY BUILDER PRIOR TO COMMENCEMENT OF ANY WORKS. ANY ERRORS, DISCREPANCIES OR OMISSIONS IN THE DRAWINGS, NOTATIONS OR DIMENSIONS SHALL BE IMMEDIATELY BROUGHT TO THE ATTENTION OF THE ARCHITECT FOR CLARIFICATION PRIOR TO WORKS COMMENCING.
 - ARCHITECTURAL DRAWINGS TO BE READ IN CONJUNCTION WITH SPECIFICATIONS, STRUCTURAL, MECHANICAL, ELECTRICAL, HYDRAULIC, LANDSCAPE ARCHITECTURAL DRAWINGS. LOCATION OF ALL HARDWARE, FIXTURES AND FITTINGS TO BE CONFIRMED WITH ARCHITECT PRIOR TO WORKS COMMENCING.

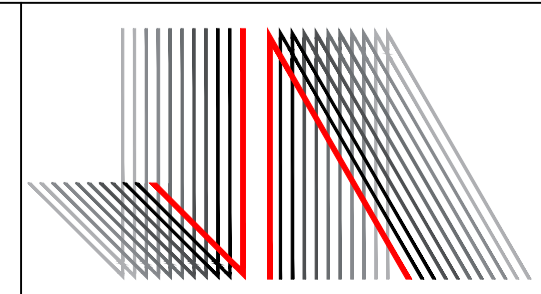

JESSE ANT ARCHITECTS
 6 / 1153-1157 Burke Road , Kew VIC 3101
 Ph: (03) 9817 6788
 Email: info@jesseantarchitects.com.au; www.jesseantarchitects.com.au
 ABN: 29 469 352 797

Project
 24-26 TAYLORS LANE, ROWVILLE

Drawing
 ROOF PLAN

Date	Rev	Description

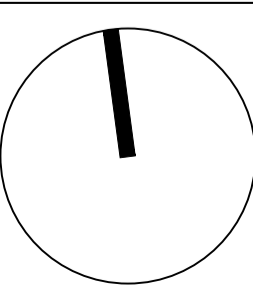

Project Number 15031		Drawing Number TP08	
Date 26-02-2018	Scale 1:200	Amendment D	
Drawn YZ	Checked AL/JW		

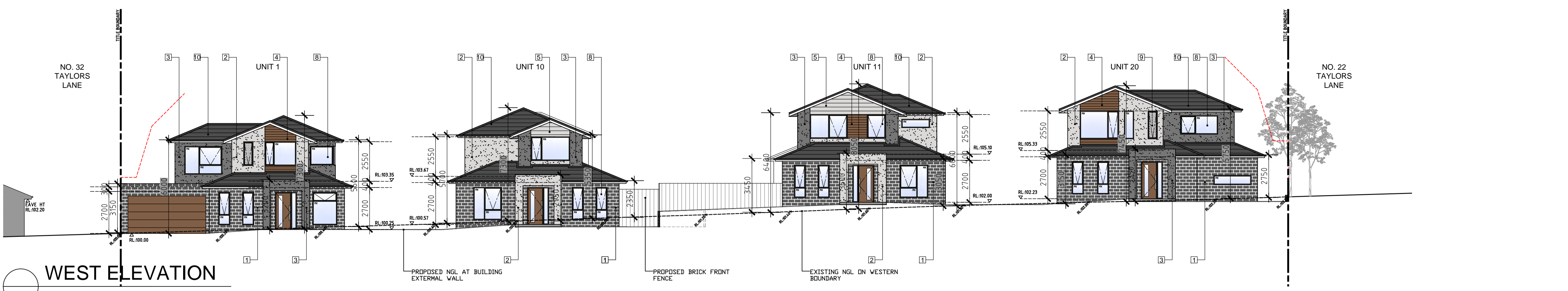

WEST ELEVATION
SCALE 1:150 @ A1

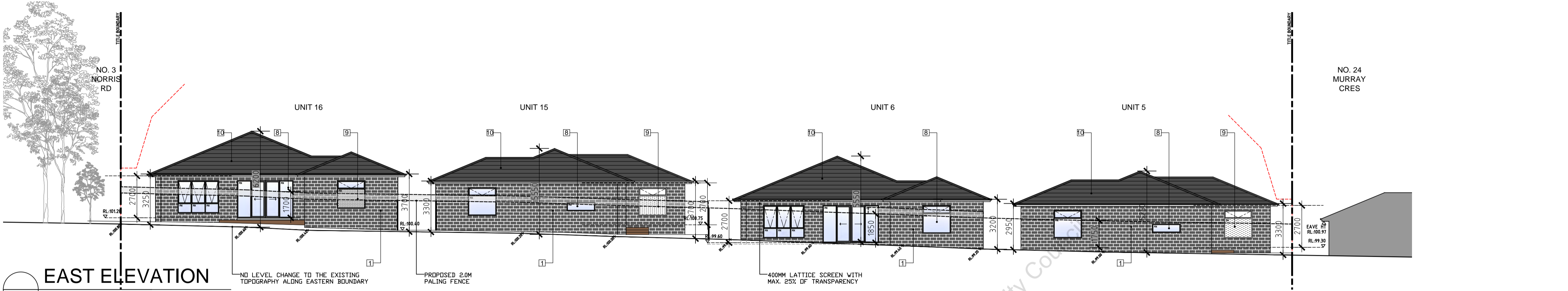

EAST ELEVATION
SCALE 1:150 @ A1

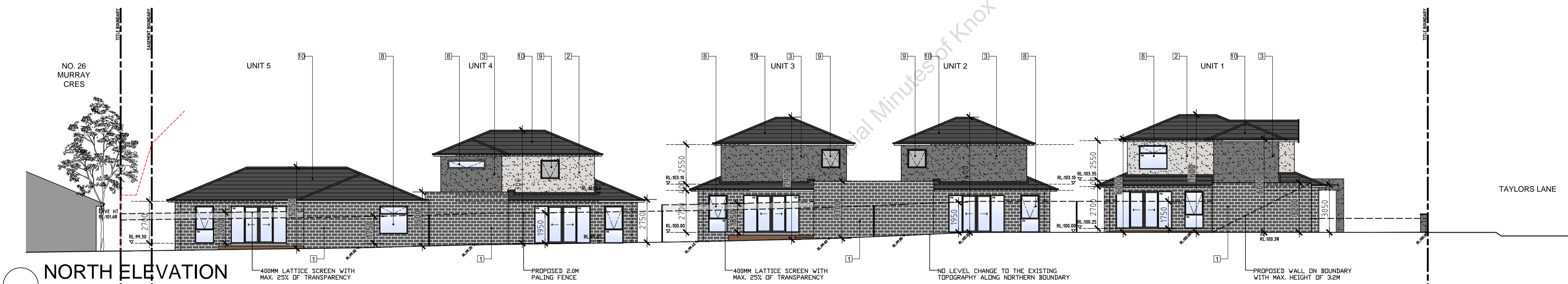

NORTH ELEVATION
SCALE 1:150 @ A1

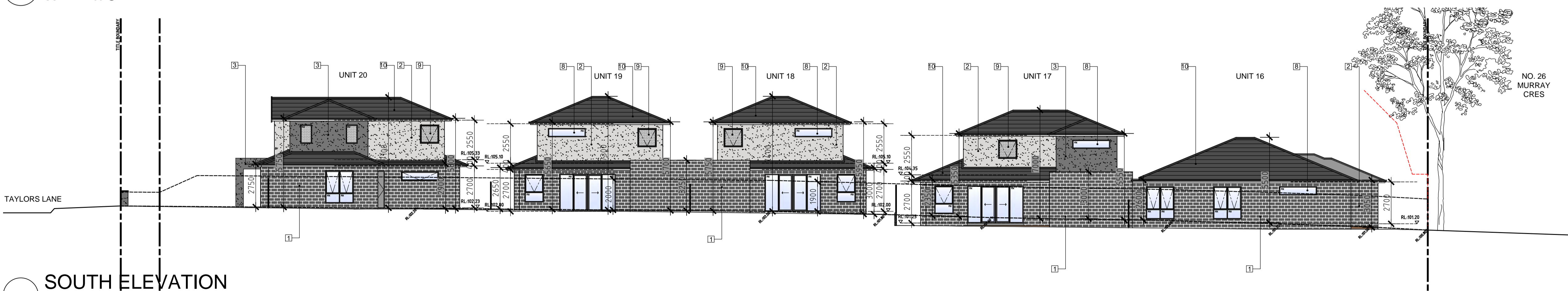

SOUTH ELEVATION
SCALE 1:150 @ A1

MATERIAL SCHEDULE:

	1 SELECTED FACED BRICK
	2 SELECTED RENDER 1
	3 SELECTED RENDER 2
	4 SELECTED TIMBER LOOK CLADDING
	5 SELECTED HORIZONTAL CLADDING
	6 SELECTED ALUMINIUM SECTIONAL GARAGE DOOR
	7 SELECTED TIMBER LOOK SECTIONAL GARAGE DOOR
	8 CLEAR GLAZING
	9 FIXED OBSCURE GLAZING
	10 SELECTED CONCRETE ROOF TILE

Notes

- DO NOT SCALE FROM DRAWINGS.
- SITE & FLOOR LEVELS TO BE CONFIRMED ON SITE BY BUILDER PRIOR TO COMMENCEMENT OF ANY WORKS. ANY ERRORS, DISCREPANCIES OR OMISSIONS IN THE DRAWINGS, NOTATIONS OR DIMENSIONS SHALL BE IMMEDIATELY BROUGHT TO THE ATTENTION OF THE ARCHITECT FOR CLARIFICATION PRIOR TO WORKS COMMENCING.
- ARCHITECTURAL DRAWINGS TO BE READ IN CONJUNCTION WITH SPECIFICATIONS, STRUCTURAL, MECHANICAL, ELECTRICAL, HYDRAULIC, LANDSCAPE ARCHITECTURAL DRAWINGS, LOCATION OF ALL HARDWARE, FIXTURES AND FITTINGS TO BE CONFIRMED WITH ARCHITECT PRIOR TO WORKS COMMENCING.

JESSE ANT ARCHITECTS
 6 / 1153-1157 Burke Road , Kew VIC 3101
 Ph: (03) 9817 6788
 Email: info@jesseantarchitects.com.au; www.jesseantarchitects.com.au
 ABN: 29 469 352 797

Project	24-26 TAYLORS LANE, ROWVILLE
Drawing	ELEVATIONS
Date	
Rev	
Description	

Project Number	15031	Drawing Number	TP09
Date	26-02-2018	Scale	1:150
Drawn	YZ	Checked	AL/JW
		Amendment	D

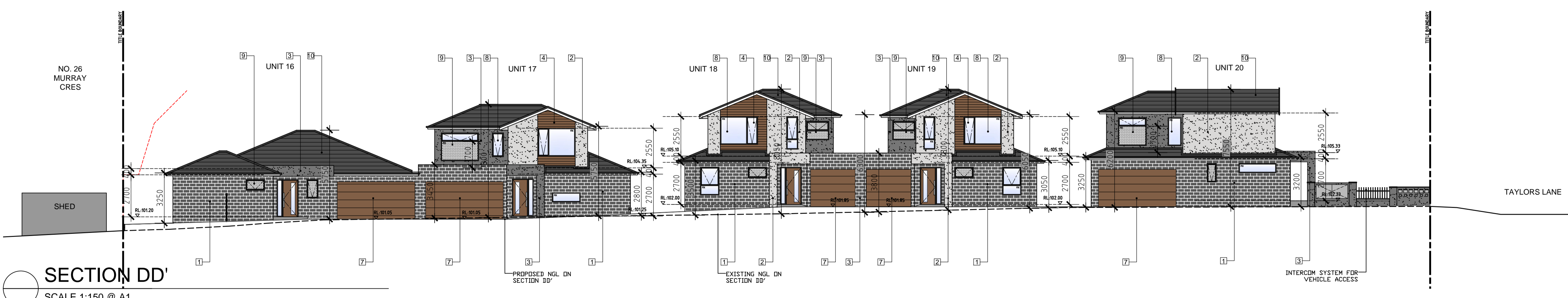
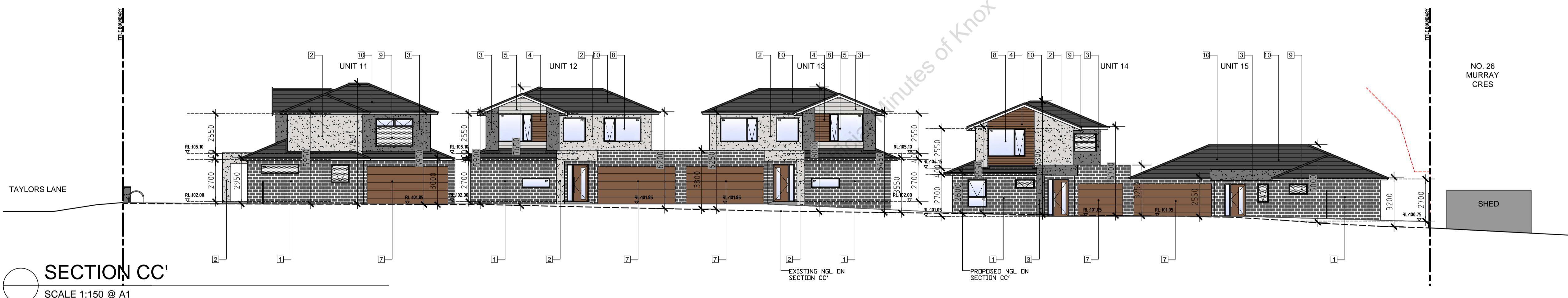
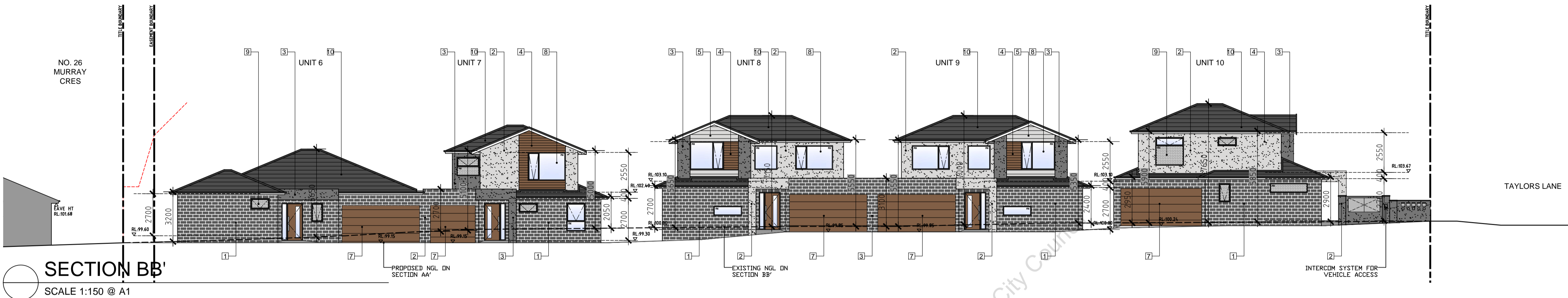
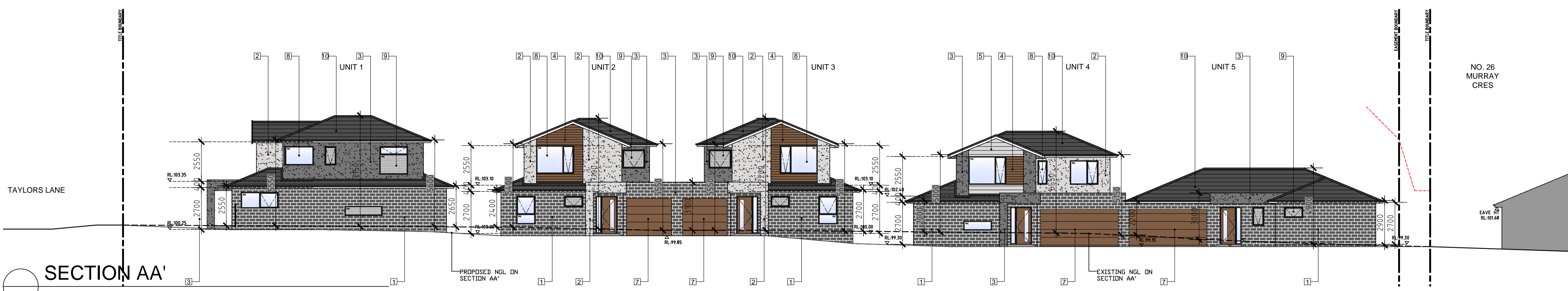

MATERIAL SCHEDULE:

	1 SELECTED FACED BRICK
	2 SELECTED RENDER 1
	3 SELECTED RENDER 2
	4 SELECTED TIMBER LOOK CLADDING
	5 SELECTED HORIZONTAL CLADDING
	6 SELECTED ALUMINIUM SECTIONAL GARAGE DOOR
	7 SELECTED TIMBER LOOK SECTIONAL GARAGE DOOR
	8 CLEAR GLAZING
	9 FIXED OBSCURE GLAZING
	10 SELECTED CONCRETE ROOF TILE

Notes

- DO NOT SCALE FROM DRAWINGS.
- SITE & FLOOR LEVELS TO BE CONFIRMED ON SITE BY BUILDER PRIOR TO COMMENCEMENT OF ANY WORKS. ANY ERRORS, DISCREPANCIES OR OMISSIONS IN THE DRAWINGS, NOTATIONS OR DIMENSIONS SHALL BE IMMEDIATELY BROUGHT TO THE ATTENTION OF THE ARCHITECT FOR CLARIFICATION PRIOR TO WORKS COMMENCING.
- ARCHITECTURAL DRAWINGS TO BE READ IN CONJUNCTION WITH SPECIFICATIONS, STRUCTURAL, MECHANICAL, ELECTRICAL, HYDRAULIC, LANDSCAPE ARCHITECTURAL DRAWINGS, LOCATION OF ALL HARDWARE, FIXTURES AND FITTINGS TO BE CONFIRMED WITH ARCHITECT PRIOR TO WORKS COMMENCING.

JESSE ANT ARCHITECTS
 6 / 1153-1157 Burke Road , Kew VIC 3101
 Ph: (03) 9817 6788
 Email: info@jesseantarchitects.com.au; www.jesseantarchitects.com.au
 ABN: 29 469 352 797

Project	24-26 TAYLORS LANE, ROWVILLE
Drawing	INTERNAL ELEVATIONS

Date	Rev	Description

Project Number		15031		Drawing Number		TP10	
Date	26-02-2018	Scale	1:150	Amendment			
Drawn	YZ	Checked	AL/JW	D			

APPENDIX C 24-26 TAYLORS LANE ROWVILLE

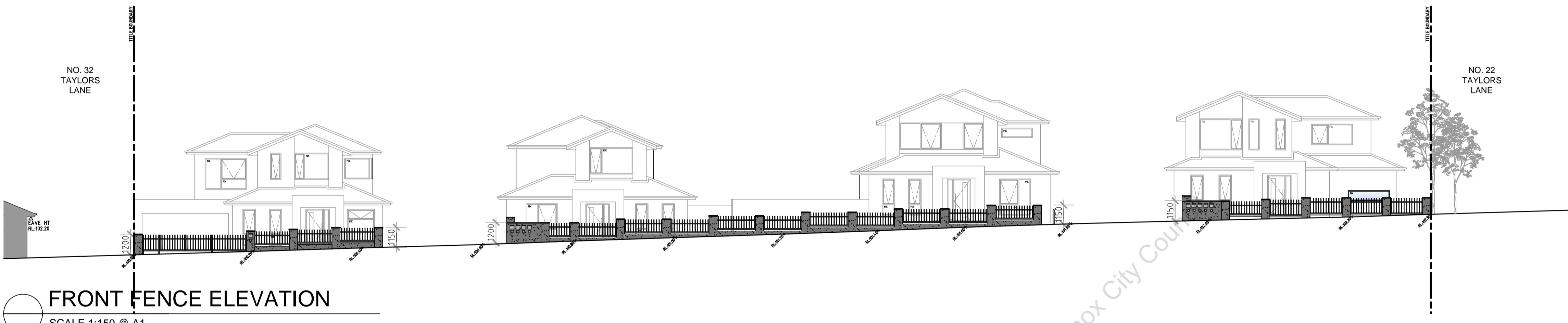

FRONT FENCE ELEVATION
SCALE 1:150 @ A1

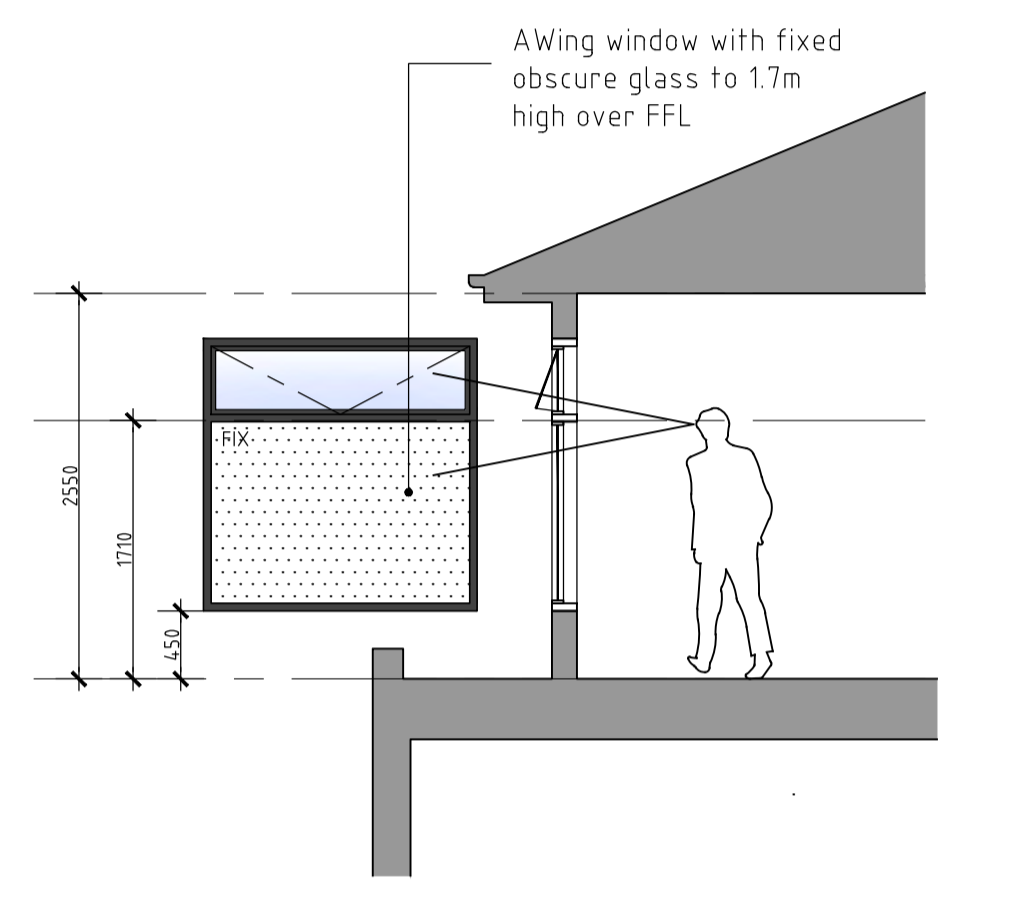
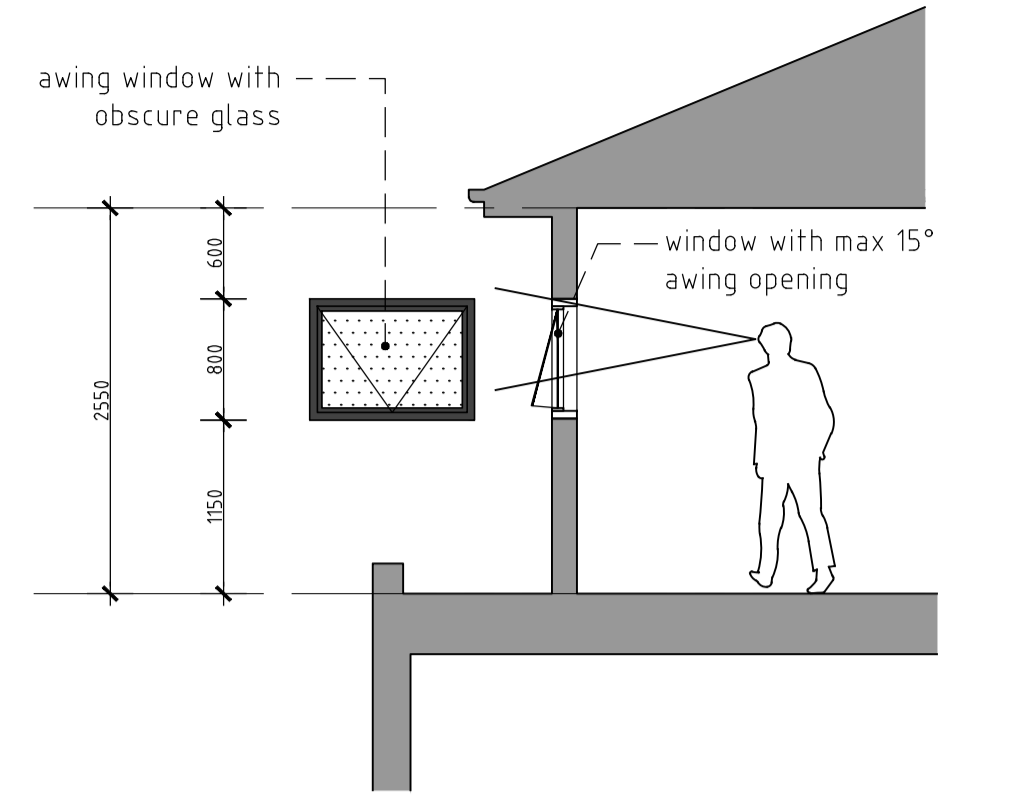

OVERLOOKING DIAGRAM
SCALE 1:50 @ A1

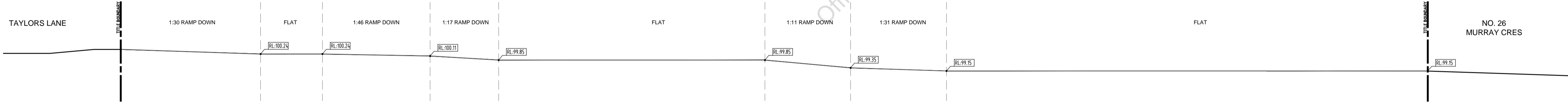

DRIVEWAY RAMP SECTION AA'
SCALE 1:150 @ A1

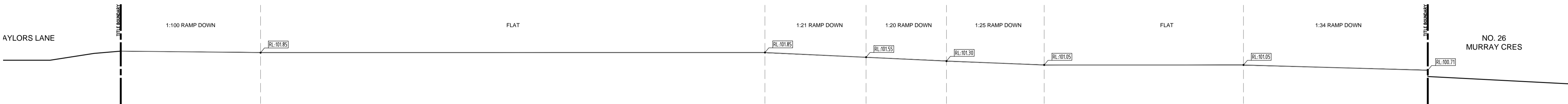

DRIVEWAY RAMP SECTION CC'
SCALE 1:150 @ A1

Notes
- DO NOT SCALE FROM DRAWINGS.
- SITE & FLOOR LEVELS TO BE CONFIRMED ON SITE BY BUILDER PRIOR TO COMMENCEMENT OF ANY WORKS. ANY ERRORS, DISCREPANCIES OR OMISSIONS IN THE DRAWINGS, NOTATIONS OR DIMENSIONS SHALL BE IMMEDIATELY BROUGHT TO THE ATTENTION OF THE ARCHITECT FOR CLARIFICATION PRIOR TO WORKS COMMENCING.
- ARCHITECTURAL DRAWINGS TO BE READ IN CONJUNCTION WITH SPECIFICATIONS.
- STRUCTURAL, MECHANICAL, ELECTRICAL, HYDRAULIC, LANDSCAPE ARCHITECTURAL DRAWINGS.
- LOCATION OF ALL HARDWARE, FIXTURES AND FITTINGS TO BE CONFIRMED WITH ARCHITECT PRIOR TO WORKS COMMENCING.

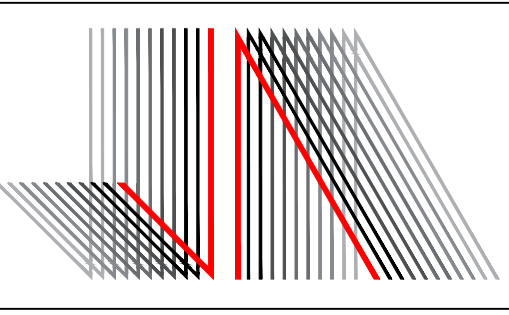

JESSE ANT ARCHITECTS
6 / 1153-1157 Burke Road , Kew VIC 3101
Ph: (03) 9817 6788
Email: info@jesseantarchitects.com.au; www.jesseantarchitects.com.au
ABN: 29 469 352 797

Project	24-26 TAYLORS LANE, ROWVILLE
Drawing	FRONT FENCE ELEVATION & RAMP SECTIONS

Date	Rev	Description

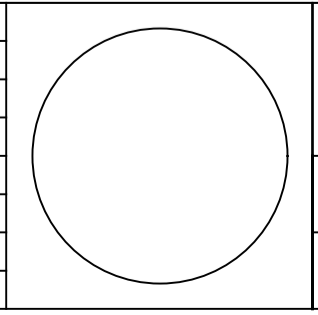

Project Number 15031	
Date 26-02-2018	Scale
Drawn YZ	Checked AL/JW

Drawing Number TP11
Amendment D

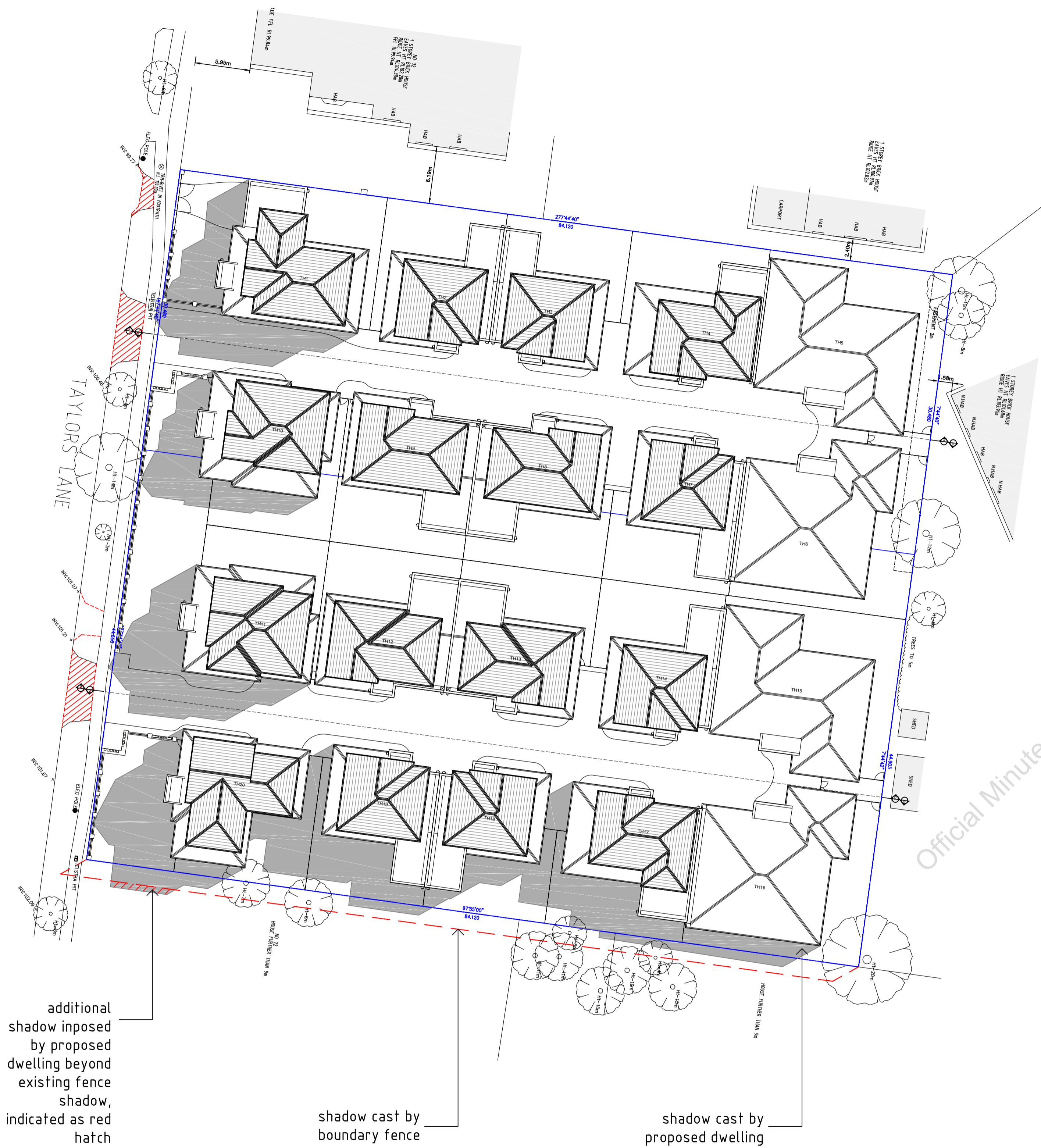

additional shadow imposed by proposed dwelling beyond existing fence shadow, indicated as red hatch

shadow cast by boundary fence

shadow cast by proposed dwelling

SHADOW DIAGRAM SEP 22 9AM
SCALE 1:300 @ A1

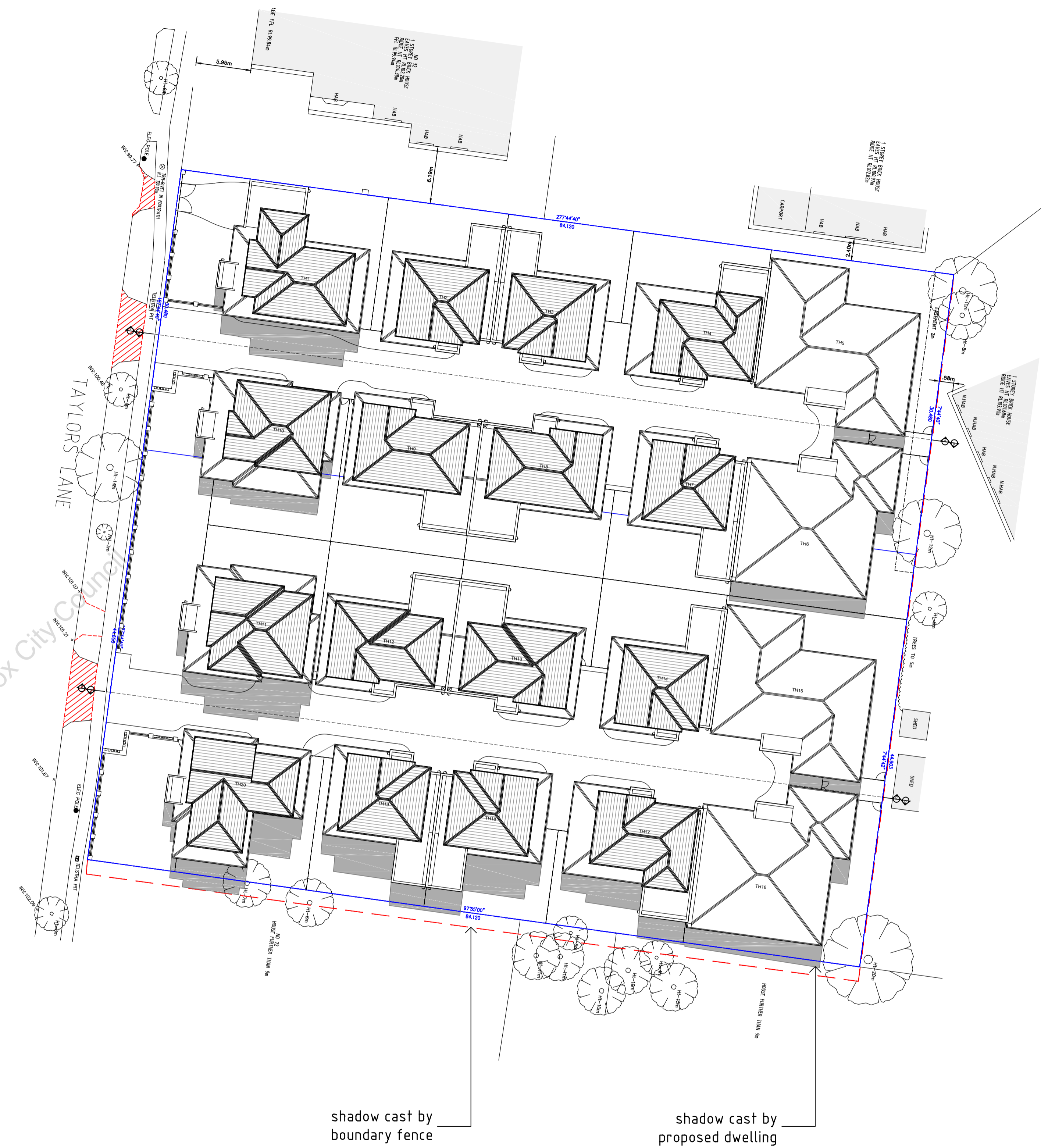

shadow cast by boundary fence

shadow cast by proposed dwelling

SHADOW DIAGRAM SEP 22 12PM
SCALE 1:300 @ A1

Official Minutes of Knox City Council

Notes
 - DO NOT SCALE FROM DRAWINGS.
 - SITE & FLOOR LEVELS TO BE CONFIRMED ON SITE BY BUILDER PRIOR TO COMMENCEMENT OF ANY WORKS. ANY ERRORS, DISCREPANCIES OR OMISSIONS IN THE DRAWINGS, NOTATIONS OR DIMENSIONS SHALL BE IMMEDIATELY BROUGHT TO THE ATTENTION OF THE ARCHITECT FOR CLARIFICATION PRIOR TO WORKS COMMENCING.
 - ARCHITECTURAL DRAWINGS TO BE READ IN CONJUNCTION WITH SPECIFICATIONS, STRUCTURAL, MECHANICAL, ELECTRICAL, HYDRAULIC, LANDSCAPE ARCHITECTURAL DRAWINGS. LOCATION OF ALL HARDWARE, FIXTURES AND FITTINGS TO BE CONFIRMED WITH ARCHITECT PRIOR TO WORKS COMMENCING.

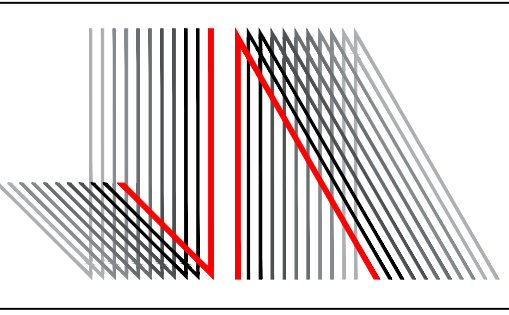

JESSE ANT ARCHITECTS
 6 / 1153-1157 Burke Road , Kew VIC 3101
 Ph: (03) 9817 6788
 Email: info@jesseantarchitects.com.au; www.jesseantarchitects.com.au
 ABN: 29 469 352 797

Project	24-26 TAYLORS LANE, ROWVILLE
Drawing	SHADOW DIAGRAMS

Date	Rev	Description

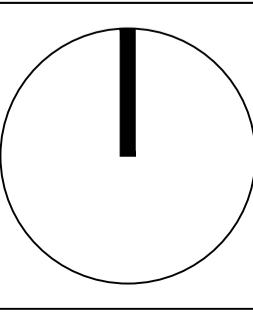

Project Number		15031	
Date	26-02-2018	Scale	1:300
Drawn	YZ	Checked	AL/JW

Drawing Number	TP12
Amendment	D

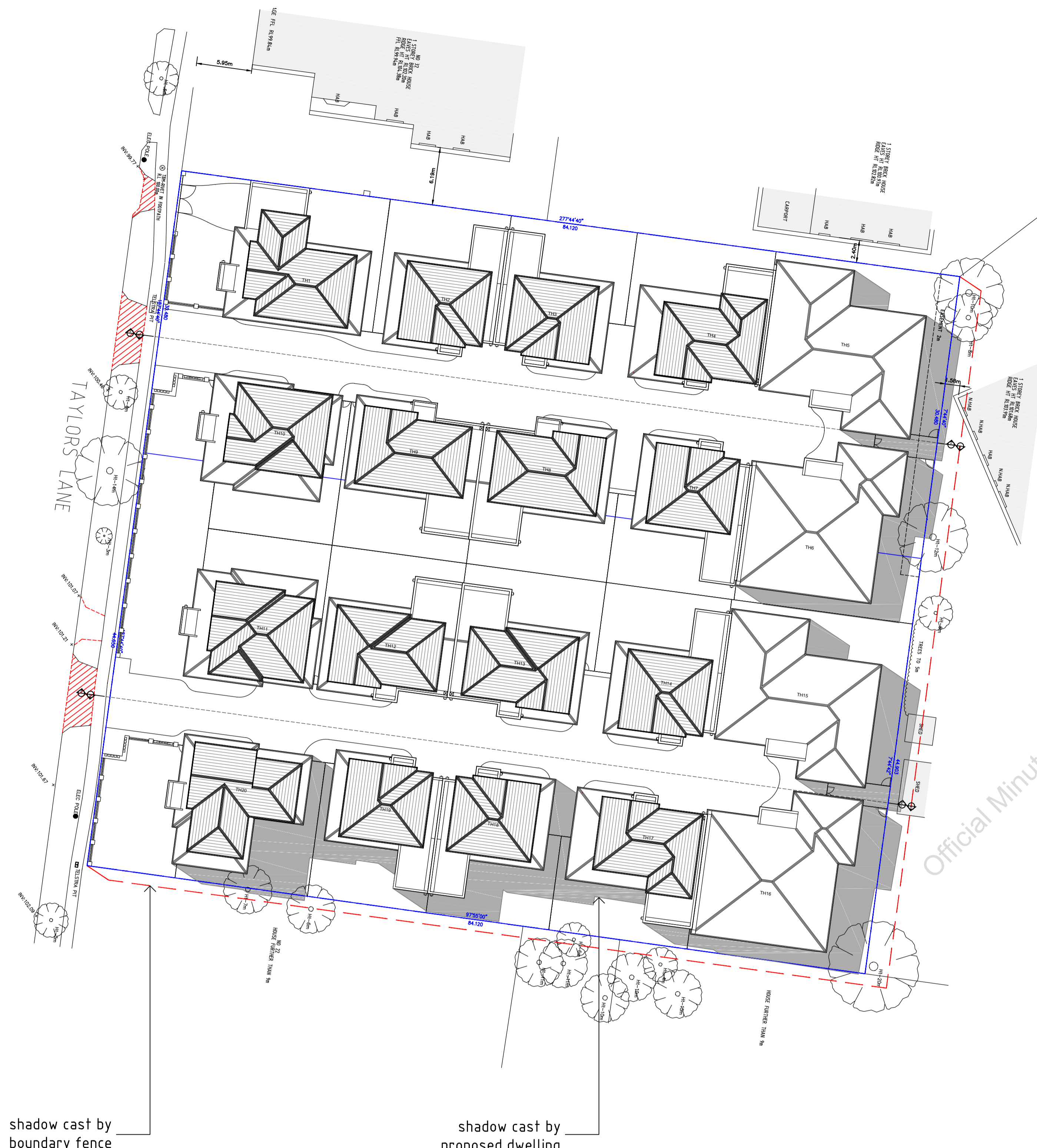

Official Minutes of Knox City Council

shadow cast by boundary fence
shadow cast by proposed dwelling

SHADOW DIAGRAM SEP 22 3PM
SCALE 1:300 @ A1

APPENDIX C 24-26 TAYLORS LANE ROWVILLE

Notes
 - DO NOT SCALE FROM DRAWINGS.
 - SITE & FLOOR LEVELS TO BE CONFIRMED ON SITE BY BUILDER PRIOR TO COMMENCEMENT OF ANY WORKS. ANY ERRORS, DISCREPANCIES OR OMISSIONS IN THE DRAWINGS, NOTATIONS OR DIMENSIONS SHALL BE IMMEDIATELY BROUGHT TO THE ATTENTION OF THE ARCHITECT FOR CLARIFICATION PRIOR TO WORKS COMMENCING.
 - ARCHITECTURAL DRAWINGS TO BE READ IN CONJUNCTION WITH SPECIFICATIONS, STRUCTURAL, MECHANICAL, ELECTRICAL, HYDRAULIC, LANDSCAPE ARCHITECTURAL DRAWINGS. LOCATION OF ALL HARDWARE, FIXTURES AND FITTINGS TO BE CONFIRMED WITH ARCHITECT PRIOR TO WORKS COMMENCING.

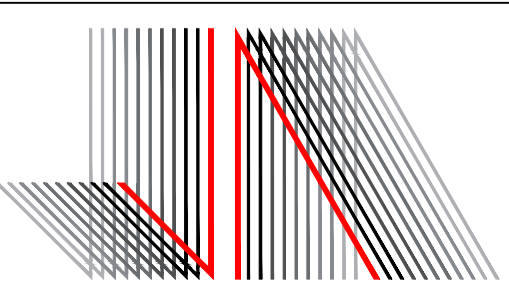

JESSE ANT ARCHITECTS
 6 / 1153-1157 Burke Road , Kew VIC 3101
 Ph: (03) 9817 6788
 Email: info@jesseantarchitects.com.au; www.jesseantarchitects.com.au
 ABN: 29 469 352 797

Project	24-26 TAYLORS LANE, ROWVILLE
Drawing	SHADOW DIAGRAMS

Date	Rev	Description

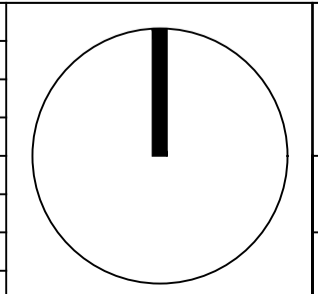

Project Number		15031		Drawing Number	TP13
Date	26-02-2018	Scale	1:300	Amendment	D
Drawn	YZ	Checked	AL/JW		

COUNCILLOR HOLLAND ENTERED THE CHAMBER AT 7.38PM PRIOR TO THE VOTE ON ITEM 6.3

ALL WARDS

6.3 RESPONSE TO CALL UP ITEM – SUNSHINE COAST COUNCIL SOLAR FARM AND OPPORTUNITIES FOR KNOX

SUMMARY: Senior Program Lead – Sustainability (Sam Sampanthar)

This report is in response to a call up item from the Ordinary Council meeting on 25 September 2017 requesting a report at the March 2018 Ordinary Meeting of Council on the following topics:

- ***Details about the Sunshine Coast Solar Farm;***
- ***Opportunities to advance renewable energy in Knox City Council;***
- ***Energy and money saved by energy efficiency projects; and***
- ***The financial implications of changing the operating rules around the Revolving Energy Fund.***

The report notes that there are many opportunities for replicating a similar approach to that of Sunshine Coast Council, including the option of co-investing in a large solar farm in Northern Victoria or investing in solar on a local landfill site. Power Purchase Agreements are another way to achieve renewable energy goals with long term energy price certainty.

RECOMMENDATION

That Council receives and notes this Call Up report.

1. INTRODUCTION

This report responds to a Call Up item from the September 2017 Council meeting as follows:

“That a report be prepared for the March 2018 Ordinary Meeting of Council outlining:

1. Details about the Sunshine Coast Solar Farm including:
 - Project location, overall investment and business case;
 - Any contribution of funding from Federal or Queensland government; and
 - Opportunities for Knox and other interested Councils to collaborate on a similar local project.
2. Related to the above, information about an opportunity for Knox Council to advance renewable energy through projects such as Solar Savers.
3. How much electricity and money has been saved by Council’s energy efficient measures to date.

6.3 Response To Call Up Item – Sunshine Coast Council Solar Farm and Opportunities for Knox (cont'd)

4. The financial benefit to Council should the current 1, 4 or 10 year cap on measuring the benefits of the Revolving Energy Fund be removed.

As part of undertaking the work required for this Call Up Item, officers have had regard to Council's Call Up Items at Council Meeting Policy, and in particular, Item 6.5 which states:

“Where preparing a report responding to a Call Up Item which will require more than three person days or \$5,000 in costs, then the matter which is subject to the Call Up Item should be referred by Council to the next budget considerations with a supporting business case for consideration along with competing priorities.”

2. DISCUSSION

2.1 Sunshine Coast Solar Farm

The Sunshine Coast Solar Farm is a 15 Megawatt large-scale solar facility which was completed in April 2017 by the Sunshine Coast Council. The \$50m solar farm was developed following several years of planning, with the Council looking at a 30 year horizon to reduce carbon emissions by transitioning to cleaner energy sources, addressing economic development opportunities and managing rising energy costs.

The financial analysis looked at the expected electricity expenditure for the Council on a business as usual basis over a 30 year period, with cumulative costs estimated to reach nearly \$320m. The solar farm was estimated to return a net saving of \$22m. The project was fully funded by the Sunshine Coast Council and did not receive any funding or grant either from the Queensland State or the Federal Government.

The farm is located on a 49 hectare site amongst agricultural land in a suburb called Valdora, approximately 10km inland from the coast. The site was chosen due to its topography and proximity to High Voltage power lines. The solar farm covers nearly half the site (24 hectares).

The energy generated from the plant is designed to offset 100% of the electricity needs of the Sunshine Coast Council. Contracts are in place to operate the facility and an energy retailer has been engaged to manage the transaction (buying and selling electricity) with the National Electricity Grid.

A summary of the business case and additional information about the Solar farm is attached as Appendix A.

6.3 Response To Call Up Item – Sunshine Coast Council Solar Farm and Opportunities for Knox (cont'd)

2.1.1 Opportunities for Knox and other councils to invest in Solar Farms

Knox City Council in partnership with the Eastern Alliance for Greenhouse Action (EAGA) is currently assessing a number of options regarding the role of large scale renewable energy both as a way of reducing our carbon impact and for managing the uncertainty of rising electricity prices. Three broad options are being currently explored to replicate the Sunshine Coast Solar Farm project and are detailed below.

Large Scale Solar Feasibility Study

A number of Greenhouse Alliances, including EAGA completed a feasibility study in August 2017 to examine the financial implications of a range of solar farm options including:

- A single council investing in a solar farm in Metropolitan Melbourne (both with and without battery storage)
- A small group of councils (8) co-investing in a solar farm in Metropolitan Melbourne or Northern Victoria
- A large group of councils (17) co-investing in a farm in Northern Victoria with different financing options (cash vs debt) and different capacity solar farms.

Key findings from the feasibility study concluded that, of the scenarios investigated, a large capacity solar farm located in Northern Victoria, without Battery storage would provide the best financial outcome.

The project also developed a modelling tool which allows any Council to carry out their own analysis for investing in solar farms using Council-specific data. For Knox, the table below shows the results of three scenarios to determine the indicative level of investment needed to fully match the energy needs of Council (i.e. 100% renewable). The scenarios include a solar farm in various locations across Victoria including Metropolitan Melbourne, Riverina and Gippsland. The calculations below exclude leasing or buying land.

The full feasibility report is attached as Appendix B. Additional State or Federal Government funding would be required to advance this feasibility study to the next stage of a detailed Business Case.

Solar Array Size (Megawatt)	Land Required (Hectares)	Location	Capital Cost (\$m)	NPV (\$m)
7.8	11.7	Metro Melbourne	\$15.6	\$1.86
6.4	9.6	Riverina	\$12.8	\$5.17
7.6	11.4	Gippsland	\$15.2	\$2.10

Table 2.1: Solar Farm Scenarios for Knox Council to meet 100% of its energy needs through solar. NPV Calculations for investment over a 25-year period. See Appendix B for full report and assumptions.

6.3 Response To Call Up Item – Sunshine Coast Council Solar Farm and Opportunities for Knox (cont'd)

Solar Farms on Landfill sites

An emerging approach in Australia is the use of low-value land such as old landfill sites for installing solar farms. Landfill sites are considered ideal for Solar as they tend to be flat and generally have good solar access with minimal shading. However, they have stringent regulatory requirements in relation to permissible uses and buffer distances that must be maintained. To overcome these, special installation techniques are adopted to avoid the penetration of landfill caps.

Newcastle City Council (NSW) has announced plans to install a 5 Megawatt solar farm on the Summerhill waste centre. The Solar farm is part of Council's target to achieve 30% of their energy use from renewable sources by 2020.

In Victoria, a smaller solar power system of approximately 100 Kilowatt capacity is the first of this type operating at Wollert Landfill near Epping. This project is part of an Australian Renewable Energy Agency (ARENA) funded project trialling various footing and foundation options for mounting solar on landfill sites.

A brief assessment of the available land at the Cathies Lane landfill indicates that up to 6 MW solar can be accommodated on site at an estimated cost of \$12m. A more detailed assessment of the potential to use landfill sites needs to be carried out including technical feasibility, engineering and grid-connection costs and is likely to cost approximately \$50,000.

Power Purchase Agreements

Power Purchase Agreements involve long term energy supply contracts with the aim of providing competitive energy rates and budget certainty for large energy consumers. The energy customer enters a long-term electricity off-take agreement with the renewable energy generator, thereby providing long term financial certainty to these projects.

A recent example of this is the Melbourne Renewable Energy Project (MREP) where the City of Melbourne, along with Cities of Port Phillip, Moreland and Yarra partnered with local Universities, Banking Institutions and other large energy users on an 80 Megawatt wind farm to supply electricity for all members of the Consortium. The wind farm near Ararat will supply up to 88 Gigawatt-hours of electricity per year to the MREP members and sell excess energy through the spot market to the National grid.

The long term Power Purchase Agreements typically span between 10 and 20 years and provide investment certainty to solar or wind energy projects while giving the energy users certainty around future retail energy costs.

6.3 Response To Call Up Item – Sunshine Coast Council Solar Farm and Opportunities for Knox (cont'd)

A long term Power Purchase Agreement is currently being explored as an alternative option to traditional energy procurement methods with Knox along with a number of other Councils expressing an interest in exploring this option. A report from Procurement Australia is expected in late 2018 at which time all Councils will be given the opportunity to decide if they wish to pursue such an agreement from the end of the next contract (in 3 to 5 years).

2.2 Opportunities for Knox to advance Renewable Energy

There are a number of opportunities for Knox Council to continue to advance renewable energy in the municipality. This includes continuing to invest in rooftop solar on new and existing Council buildings. It is expected that up to 30% of Council's overall energy use can be offset by installing rooftop solar on Council facilities.

Knox, along with a number of EAGA councils will be investigating the most cost efficient way to design and install solar on medium sized community facilities. This project has been part funded by Local Government Victoria and will work with the participating EAGA member Councils to assess and prioritise sites, compare and contrast technology and develop coordinated implementation and procurement plans. This project is expected to be completed by December 2018 and will inform the 2019/20 budget process for potential projects.

In the community, Solar Panels continue to be a popular choice, with just over 15% of Knox community installing solar panels (including approximately 20% of Rowville households). Knox has promoted solar uptake through programs such as Solar Bulk Buy Programs, Solar Savers as well as workshops and assisting community groups and individuals with enquiries.

The Solar Savers program has received over 300 enquiries from pensioner households with 35 residents having solar panels installed to date. Another 50 residents are in the process of obtaining a quote or evaluating their quote. Programs such as Solar Savers provides a great opportunity for Council to continue to promote solar systems with Bulk Buy programs and workshops to help provide independent advice to the Knox community.

2.3 Energy and Cost Savings from the Revolving Energy Fund

The Revolving Energy Fund has been in operation since 2006/07 through the Sustainability Initiatives Capital Works program. The program has seen improvements to lighting, air conditioning and solar on a number of Council properties. The cost savings from these projects are then reinvested in future energy efficiency projects. To date, the projects are estimated to have delivered cumulative savings of nearly \$450,000 in energy expenditure and on average 310,000 Kilowatt-hours of electricity per annum. As of 28th of February 2018, \$71,138 is available in the Revolving Energy Fund.

6.3 Response To Call Up Item – Sunshine Coast Council Solar Farm and Opportunities for Knox (cont'd)

2.4 Implications of removing 1, 4 and 10 year cap on measuring benefits

The Revolving Energy Fund has a cap on how long benefits from implementing an energy saving project are reinvested into future projects. All projects are classified based on the technology used – initiatives that use long lasting products (e.g LED, Solar or Insulation) were classed as 10 year projects - where the annual energy savings from those projects were reinvested for a period of 10 years.

For example, if a LED lighting replacement project has an energy saving of \$800 per annum, then \$8,000 over 10 years would be reinvested through the Revolving Energy Fund. However, if the lighting project used T5 Fluorescent technology, then the savings would apply for only 4 years, as fluorescent tubes would not last as long as LED lights, and claiming the energy saving benefit beyond the expected life of the technology goes against the intent of the Revolving Energy Fund. While some projects like Solar and Insulation will last much longer than the 10 years, their performance and effectiveness could start to diminish as the asset ages. Solar Panels would also require replacement of Inverters, which have a lifespan of between 7 and 12 years.

Given the above, there would be no net change to the cumulative savings from the Revolving Energy Fund to date by removing the 1, 4 and 10 year cap on reinvesting the savings.

3. CONSULTATION

In developing this report, publicly available information from Sunshine Coast Council, Newcastle City Council and Melbourne City Councils were accessed. Consultation also occurred with EAGA staff.

4. ENVIRONMENTAL/AMENITY ISSUES

Switching to renewable energy is consistent with the objectives of the *Climate Change Response Plan 2012-2022*.

5. FINANCIAL & ECONOMIC IMPLICATIONS

In developing this report, Council's Call Up Items at Council Meeting Policy was adhered to.

6. SOCIAL IMPLICATIONS

Not applicable.

6.3 Response To Call Up Item – Sunshine Coast Council Solar Farm and Opportunities for Knox (cont'd)

7. RELEVANCE TO KNOX COMMUNITY AND COUNCIL PLAN 2017-2021

This report is consistent with the following goal of the Knox Community and Council Plan 2017-2021:

Goal 1 – We value our natural and built environment

Strategy 1.1 Protect and Enhance our natural environment

Including the following Council Targets:

- A reduction in greenhouse gas emissions
- An increase in the usage of renewable energy

8. CONFLICT OF INTEREST

Under section 80c of the Local Government Act 1989 officers providing advice to Council must disclose any interests, including the type of interest.

Officer Responsible – Tanya Clark, Manager City Futures - In providing this advice as the Officer Responsible, I have no disclosable interests in this report.

Author – Sam Sampanthar (Senior Program Lead – Sustainability) - In providing this advice as the Author, I have no disclosable interests in this report.

9. CONCLUSION

Sunshine Coast Council pioneered the concept of local governments investing in large scale solar farms as a way of driving economic activity, reducing greenhouse emissions and realising savings in energy expenditure. The \$50m solar farm is performing above expectations in the first 12 months of operation.

Following Sunshine Coast Council's lead, a number of other Councils have invested in renewable energy projects – including Solar Farm at a Landfill at Newcastle (NSW) and a Consortium led by City of Melbourne entering a long term Power Purchasing Agreement from a wind farm near Ararat.

Knox along with other members of the Procurement Australia group have expressed an interest in exploring Power Purchasing Agreement as a way of providing long term price certainty and smoothing out steep increases in power prices at the end of each retail electricity contract term.

6.3 Response To Call Up Item – Sunshine Coast Council Solar Farm and Opportunities for Knox (cont'd)

In the meantime, rooftop solar on Council buildings should continue to be a focus for Councils as up to 30% of the energy needs can typically be provided by rooftop solar. A recent grant awarded to Knox along with four members of the Eastern Alliance for Greenhouse Action will explore the most cost efficient design and procurement options to scale-up rooftop solar in Council facilities.

10. CONFIDENTIALITY

There are no issues of Confidentiality associated with this report.

COUNCIL RESOLUTION

MOVED: CR. GILL
SECONDED: CR. MORTIMORE

That Council

1. Include 50% of the annual cost savings from the energy efficient street lighting project into the revolving energy fund from the 2019-2020 budget onwards.
2. Refer a business case of \$50,000 for a technical feasibility on the use of Landfill sites as a solar farms in 2019-2020 budget process.

LOST

COUNCIL RESOLUTION

MOVED: CR. TAYLOR
SECONDED: CR. GILL

That Council

1. Receives and notes this Call Up report.
2. Consider that 50% of the annual cost savings from the energy efficient street lighting project into the revolving energy fund be referred to the 2019-2020 budget process.
3. Refer a business case of \$50,000 for a technical feasibility on the use of Landfill sites as solar farms in 2019-2020 budget process.

CARRIED



Due for completion
mid-2017

Australia's first local government solar farm will offset 100% Sunshine Coast Council's electricity consumption and save \$22 million (after costs) over a 30-year period.

Sunshine Coast Solar Farm

Powering our future

7.1
hours

of sunlight on average per day*

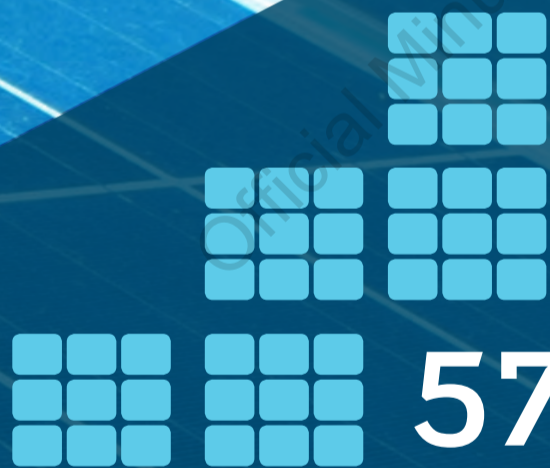

57,850
panels

15 megawatt utility-scale solar farm



36,000 trees to be planted for a **10m** green buffer area



Enough electricity to power **5,000** homes

*source: Bureau of Meteorology Climate Statistics

For more information, visit council's website and search 'Sunshine Coast Solar Farm'



Sunshine Coast Solar Farm Project

Business Case Summary

May 2016

Official Minutes of Knox City Council

Contents

	Page/s
• Policy perspective	3 - 5
• Project walk through	6 - 10
• Unique aspects of the Solar Farm project	11
• Why the Valdora site	12
• Project timeline	13
• The tender process	14
• How the Solar Farm will look	15 - 17
• Looking to the future	18
• Summary	19

Policy perspective: a mandate from the community

- **2009 ‘Regional Energy Opportunities’ Report**
 - Externally prepared
 - Considered: wind, wave, tidal, biogas, gas co-generation, biomass, solar thermal, solar PV and hydroelectric with solar PV most viable
- **2010 (June) – Council adopt ‘Climate Change & Peak Oil Strategy’***
 - Actions (8.3, 8.4, 8.5) include investigating the viability of alternative energy sites in rural areas
- **2010 (December) – Council adopt ‘Energy Transition Plan 2010-2020’***
 - *Action 11: ... allow renewable energy generation as a complement to primary production on rural land*
 - *Action 5: ... implement a clean energy solar program include facilitating large scale energy production and solar power stations*

**Underwent community consultation*

Policy perspective: a mandate from the community

- **2011 Development Application (MCU) for 909 Yandina-Coolum Rd***
 - MCU for a major solar PV utility
 - Negotiated Decision Notice issued August 2011
- **2013 (April) – Council adopt ‘Rural Futures Strategy’***
 - Informed/guided by Rural Futures Background Study which identified ‘fuel farms’ may emerge including solar ... as alternative rural area land use
- **2013 (December) – Council adopt ‘Regional Economic Development Strategy 2013-2033’***
 - Focus on high-value industries such as ‘Clean Technology’ to generate 100,000 jobs

**Underwent community consultation*

Policy perspective: summary

- **Extensive supporting policy**
- **Policies underpinned by community support for:**
 - Alternative energy
 - Renewable energy in rural areas
 - Identifying viable renewable energy sites
- **Identified Solar PV as most viable renewable energy option**
 - Community uptake of solar PV shows significant support (with 30,000 systems installed)
- **Alternative use for Canelands, such as solar, also supported**
- **Economic development through Clean Technologies identified**
- **Council voted in on a platform of Action and Implementation**

Project walk through

	Page
• Financial Analysis	7
• Does solar PV make financial sense for Council?	8
• Testing our assumptions	9
• Why not rooftop solar at Council facilities?	10

Financial Analysis

Cost Component	BAU 30 Year NPV \$ million
Energy Charges	\$(78.7) m
Carbon Charges	-
Electricity Network Charges	\$(132.8) m
Service & Maintenance	\$(98.5) m
Other Charges	\$(9.4) m
TOTAL	\$(319.2) m

Does solar PV make financial sense for Council?

Type of Cost	BAU NPV \$millions	Project NPV \$millions	Diff \$millions
Energy Charges	\$(78.7) m	\$(35.4) m	\$43.3 m
Carbon Charges	-	-	-
Network Charges	\$(132.8) m	\$(132.8) m	-
ENERGEX Service & Maintenance	\$(98.5) m	\$(98.5) m	-
Other Charges	\$(9.4) m	\$(9.4) m	-
Total electricity costs	\$(319.2) m	\$(276.0) m	\$43.3 m
Total Project Spend	-	\$(50.4) m	\$(50.4) m
Operating cost	-	\$(10.6) m	\$(10.6) m
Large scale generation certificates	-	\$22.6 m	\$22.6 m
Electricity Export	-	\$12.8 m	\$12.8 m
Solar farm terminal value	-	\$4.4 m	\$4.4 m
Total costs	\$(319.2) m	\$(297.1) m	\$22.1 m

Testing our assumptions

Solar Farm Project Simulation (10,000 Trials)

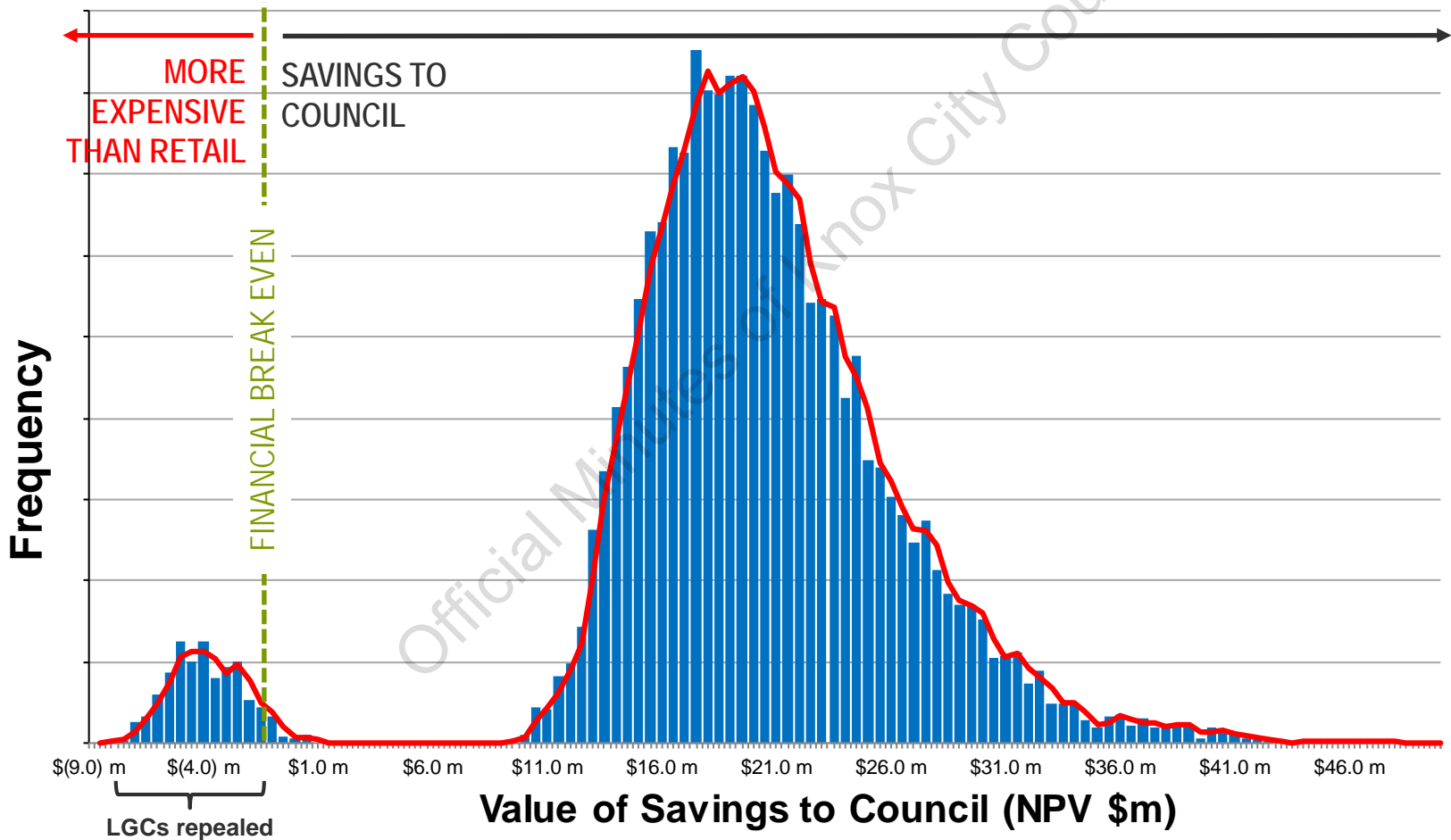

Why not rooftop solar at Council facilities?

- **Council explored rooftop solar**
 - Commissioned an external report by Auzion Alliance - March 2012
 - Looked at 10 Council buildings/six Council land sites - extrapolated results
- **In total rooftop solar only meets 5-10% of Council's electricity requirement**
 - With some sites being NPV negative
- **Some Council facilities are simply not suitable for rooftop solar**
 - By virtue of their consumption/layout – eg Aquatic Centres
 - Structural advice from Council's Facilities Management Unit
- **Council has implemented rooftop solar on 24 buildings**
 - 158kW installed capacity

Unique aspects of Council's project

- **Council is its own customer**
 - Removes margin and credit risk making it cheaper
- **Not a selective use of capital**
 - One way or another electricity usage is going to cost ~\$60 million
- **Low financing costs**
 - Borrow at lower rates and for longer than commercial equivalents
- **Long-term view**
 - Commercial enterprise is looking for a return sooner; Council can be patient
- **Social benefits**
 - Educational benefit not realised by commercial players
- **Economic benefit**
 - Direct and indirect region specific investment benefits do not help external investors

Why the Valdora site?

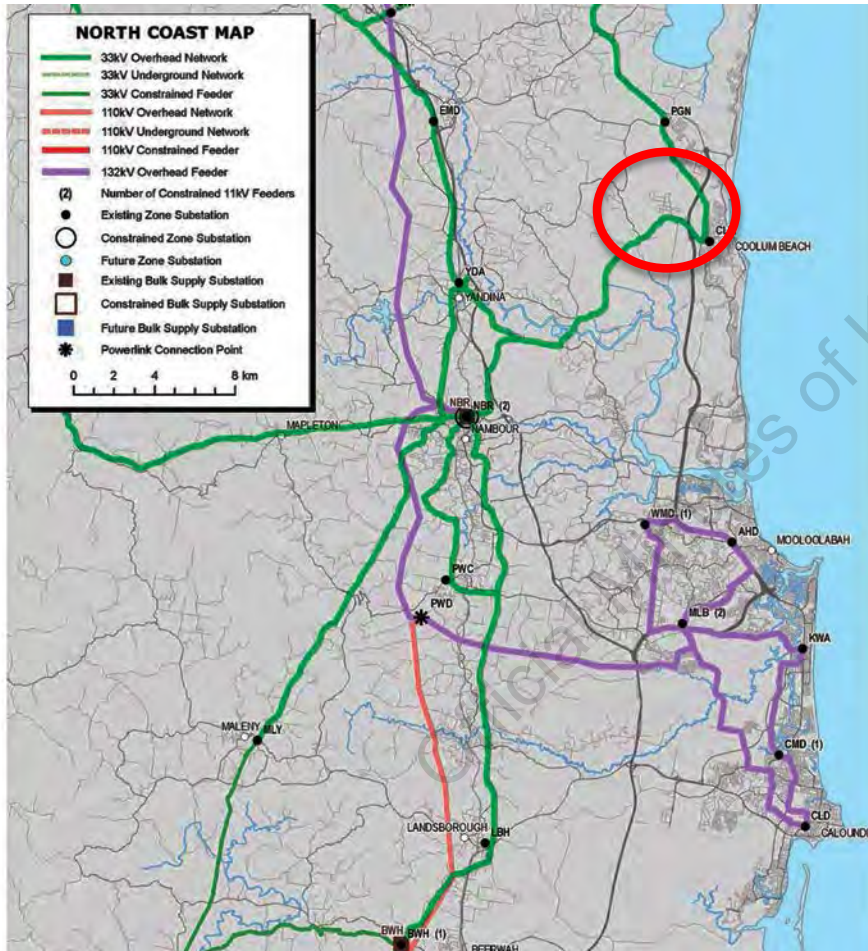

- **33kV line critical for connection**
 - Close proximity - \$1m per km to connect
- **Needs to connect at the 'right point' on the 33kV line**
 - Network/line must have adequate capacity to absorb power injection from farm
- **Other crucial criteria**
 - Protected land removed (eg water bodies, conservation areas)
 - Urban and rural residential 'footprint' removed
 - Big enough (>30 ha)
 - Flat (<5% slope)
 - Available
- **One real viable location**
Yandina-Coolumb Rd powerline

Project timeline

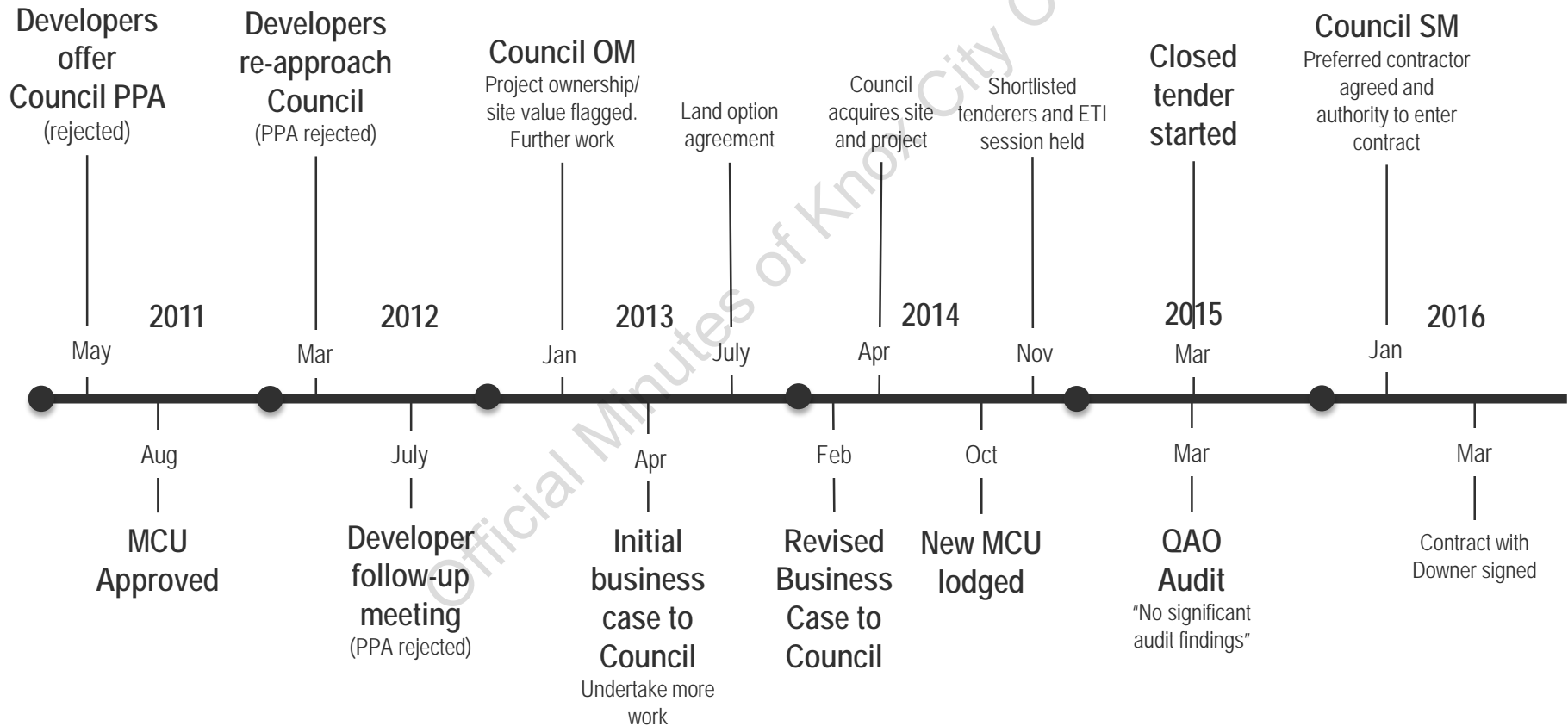

The Tender Process

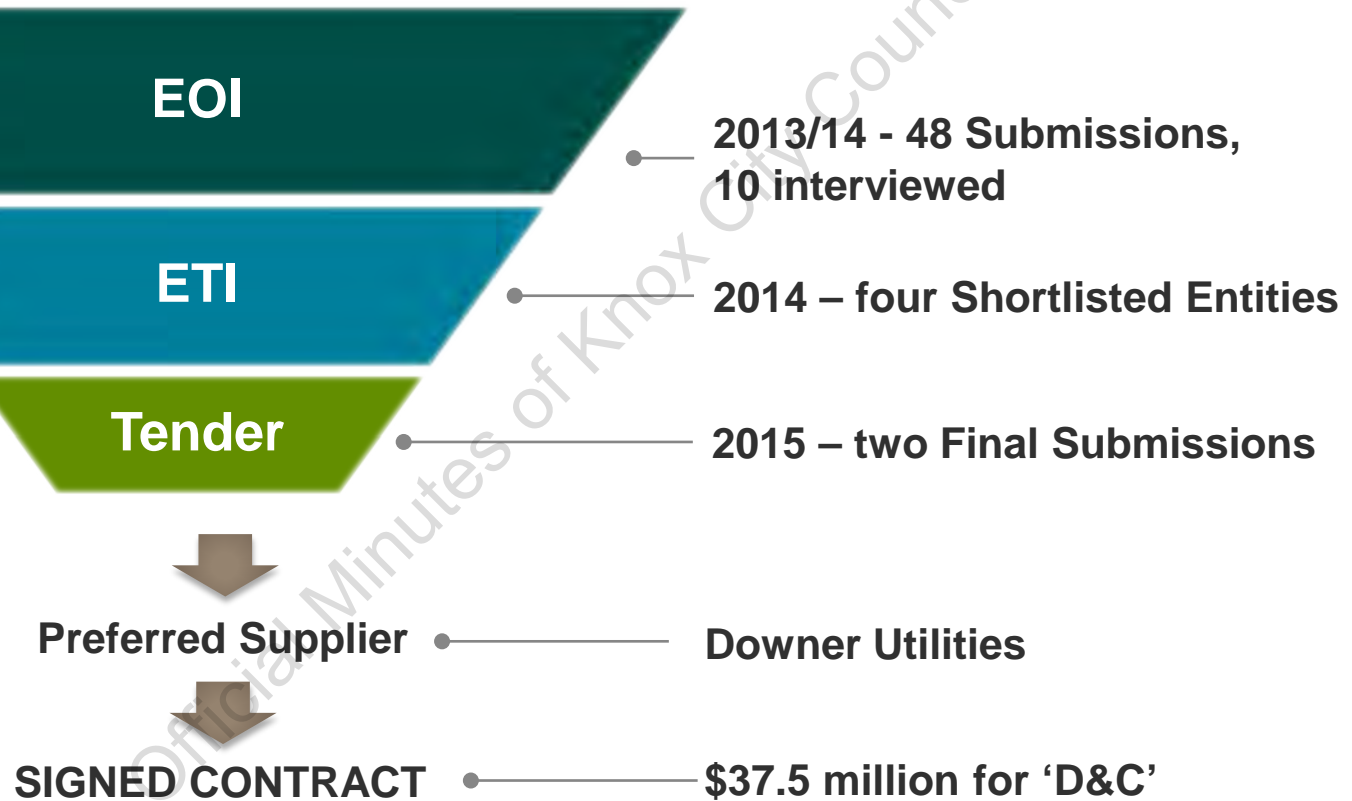

How the Solar Farm will look – aerial view

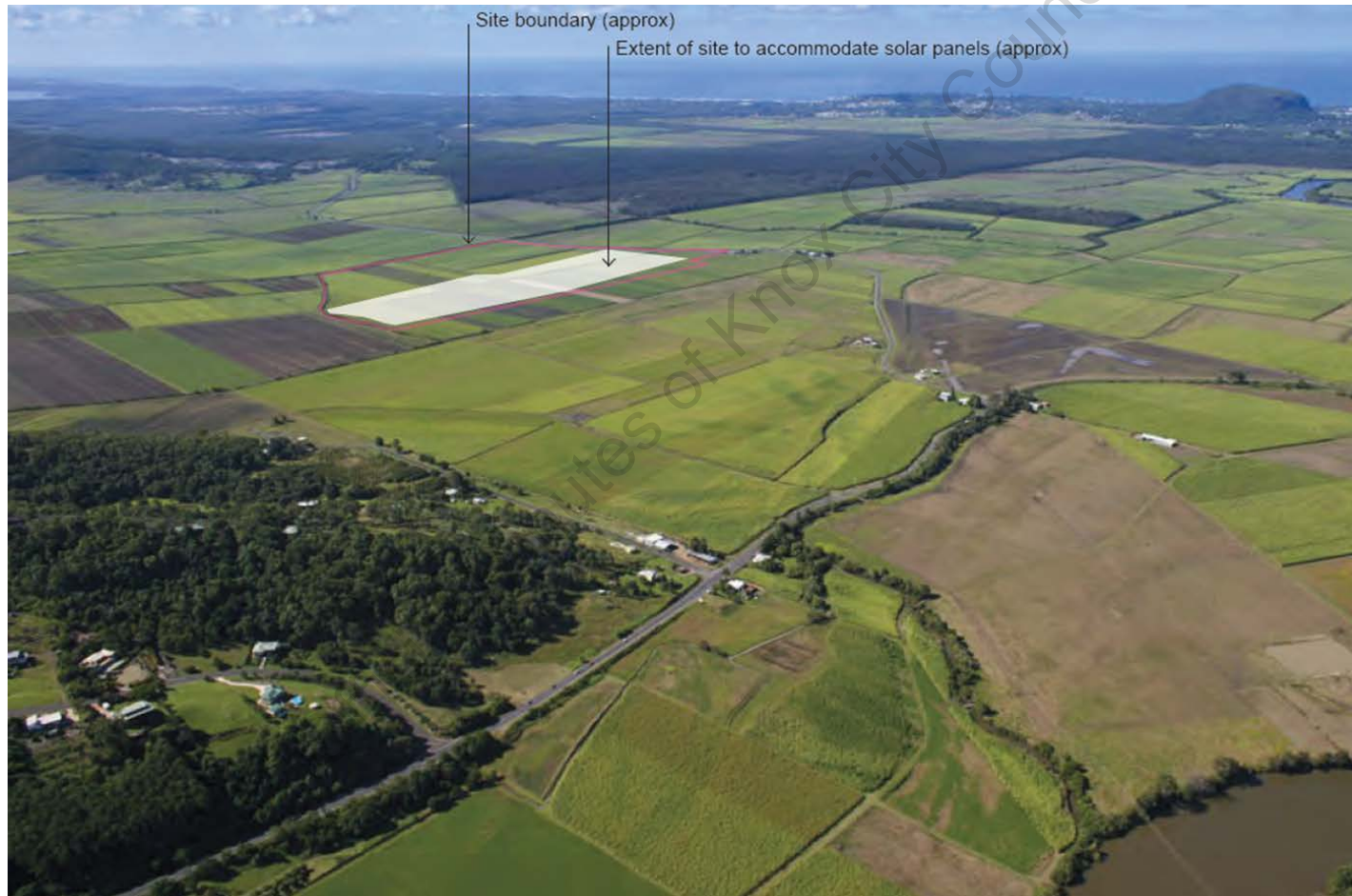

Layout Plan

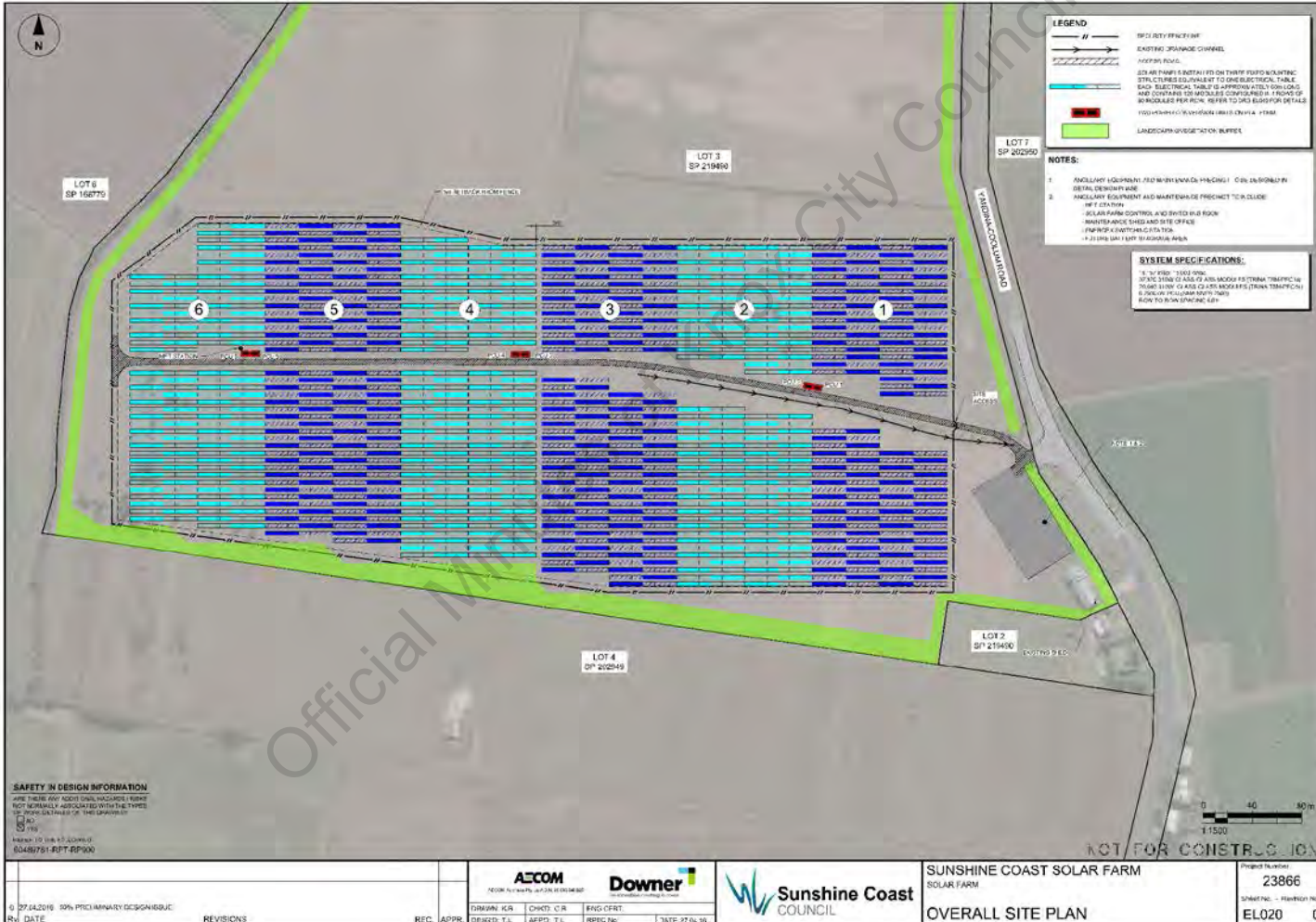

Ocean Vista Drive (1.9km away)



Karnu Drive (4.0km away)



Looking to the future

- **Design and Construction contract is signed**
- **Contractor Downer has possession of the Valdora site**
- **Practical completion of build is expected by April 2017**
- **ENERGEX is fully supportive**
- **Electricity retailer is on board for flexible retail strategy**
- **Two-year Operations and Maintenance contract is signed**

Official Minutes of Knox City Council

Summary

- **Strong community and policy support**
- **Not a ‘selective’ use of capital**
 - We are paying for electricity one way or another
- **Extensive due diligence**
 - Peer review and extensive industry consultation
- **Staged Council decision-making approach**
 - Numerous meetings/presentations to Council with more planned
- **Significant social and economic benefits**
 - Impact future young residents
 - Drive the development of new economies
- **Tier 1 contractor to build and operate facility**

Sunshine Coast Solar Farm

Powering our future



Frequently asked questions

Why is council planning to build a solar farm?

Just like Sunshine Coast residents who have collectively installed more than 30,000 rooftop solar photovoltaic (PV) arrays for their urban and rural residences or workplaces in the past five years, Sunshine Coast Council has been carefully weighing up its renewable energy options in a bid to save ratepayers from ongoing electricity cost increases and to reduce Australia's carbon footprint.

Following extensive research, council has chosen solar power as the most sustainable future energy option, which offers millions of dollars in savings to council over a 30-year period. It also reduces the exposure to future increases in electricity costs. Unlike the residents of the Sunshine Coast, council does not have adequate roof space to install the number of solar panels required to offset ongoing electricity requirements of the community facilities and services it provides. One example is the numerous aquatic centres across the region. These are an important community asset – and one of the biggest users of electricity, with insufficient roof space on which to install solar panels. So, an alternative centralised and grid-connected farm is the best renewable energy solution for council. The power generated from a grid-connected farm will then be capable of indirectly providing electricity to all council sites including its community facilities such as these energy intensive aquatic centres. Any additional renewable energy generated will be exported into the grid. This solution not only delivers great outcomes for ratepayers, it also supports council's vision to be Australia's most sustainable region – vibrant, green, diverse.

Where is the solar farm located?

The solar farm is being built at 909 Yandina-Coolum Road, Valdora (more formally described as Lot 3 on SP219490).

Why is this a good site for a solar farm?

The location is critical, and a substantial investigation revealed this site had a number of key characteristics to build a utility scale solar farm. Most importantly, it is in close proximity to a 33kv Energex line capable of receiving the solar farm's power output. This site is already zoned as a suitable site for a renewable energy facility in the Sunshine Coast Planning Scheme 2014. The site selection was very carefully guided by specific qualities of the location. The site is flat and large enough to develop a scale of solar farm which can generate a reliable output to match council's annual power needs; has the optimum solar perspective with limited impacts on the community and was available for purchase.

What activity will occur while the solar farm is being built?

The build phase of this project is expected to be completed mid-2017 and the impact on local residents will be minimal. There will be an increase in traffic along the Yandina-Coolum Road with construction vehicles travelling to the site however there should be no major disruptions to this road while construction is occurring.

Who is building the solar farm?

Downer Utilities Australia Pty Ltd (Downer) has been contracted to build the solar farm. Energex will build the infrastructure to connect the solar farm to the distribution network. Council has engaged electricity retailer Diamond Energy.

How many local jobs will be created, both in construction and once the site is established?

It is anticipated that the construction phase of the solar farm will generate up to 60 local jobs. Once the solar farm is operational, maintenance will be undertaken by the solar contractor. Downer and council have developed a local industry participation plan to ensure that local businesses and workers are appropriately supported to become involved with the project. Council hopes to leverage the solar farm to develop a 'Clean Tech' hub in the region. This hub provides opportunity to further develop this industry sector, encourage increased external investment in the region, and help drive increased and sustainable employment.

What are the project's timeframes?

The design, build and commissioning phase of similar projects of this size typically take about 12 months. It is anticipated that the project will be completed by early 2017.

How much will the solar farm cost?

The project will cost \$50.4 million, with the key components including the contracted design and build cost (\$37.5m), site related costs (\$4.3m), the Energex connection (\$2.5m), approvals and consultancies (\$2.7m), a Research and Development/Visitor Centre (\$1m) and buffering works (\$0.5m).

How much will the solar farm cost ratepayers to maintain?

The Sunshine Coast Solar Farm is structured in such a way that there will be no ongoing net cost to ratepayers. The revenue generated by the project will more than offset any associated financing costs to build the farm and ongoing costs to operate and maintain the facility. In fact, the project is expected to generate revenue for council given surplus electricity can be exported back into the grid and the solar farm is expected to generate more electricity than required by council. The positive financial dynamics of this project were crucial in determining whether the project would be supported by Council.

Are there going to be issues with glare from the solar panels?

Solar panels are designed to absorb the sun, not reflect it. Also, as a condition of the approved development application, all coatings on cables and structures must be anti-reflective. As the site will be closed at night time, there will be no lighting at this time and no glare.

Will there be landscape buffering around the site?

Landscaping will include a 10 metre wide vegetation buffer along the site frontage. There will also be buffering down the entire length of the southern boundary.

What happens to the solar farm after the 30-year life expectancy of the project expires?

Council is optimistic that the solar farm will continue to provide green energy past the current 30-year forecast period. Any removal, recycling or decommissioning of plant and equipment from the site will be undertaken with zero or better environmental impact, maintaining the positive environmental impact of the overall project. Council is keen to ensure the environmental positives gained by producing emission-free electricity are not undermined as part of the decommissioning phase.

What measures have been taken to protect the solar farm infrastructure from potential flooding?

A comprehensive flood study, based on the most up-to-date information, was undertaken by an industry leading consultancy in conjunction with council. The infrastructure solution developed has been specifically tailored for cane land sites. Special attention has been given to the mounting structure, electrical infrastructure, civil infrastructure, drainage and operational issues. All key components will be raised above the 1:100 flood level with most at 4.2m. The highest recorded flood level is 3.4m in 1992.

Why must the project connect to a 33kV overhead line?

Any overhead electricity line smaller than 33kV is not capable of taking the output from a large farm and supply electricity adequate in volume to satisfy council's electricity needs. The size of line above 33kV requires more sophisticated connection assets when linking to the Energex grid. This would be much more costly – more than 10 times the cost of connection to the 33kV line – and would consequently make the solar farm financially unviable.

Why has the solar farm size gone from 10MW to 15MW?

Council's research demonstrates that significantly more environmental and economic value can be gained by building a solar farm that has a greater peak output. Improvement of panel efficiency has also reduced the amount of additional footprint required from the original 10MW solar farm proposal.

Energex has also indicated that 15MW is the maximum capacity that can be sustained on the 33kV overhead line next to the site at Valdora. Also, given a proportion of the solar farm project costs are fixed (such as land and grid connection asset costs), building a larger farm allows more value to be released as more electricity is generated per unit of fixed cost. This increases the savings to council to ratepayers. It also has environmental benefits by increasing solar energy output.

Will the solar farm contribute to the Sunshine Coast's renewable energy targets?

In 2010, Sunshine Coast Council adopted the Sunshine Coast Energy Transition Plan 2010-2020 which set a target to reach 100 MW of low carbon energy generation capacity by 2020. The Sunshine Coast Solar Farm will provide a clear and direct response to the key actions included in the Energy Transition Plan, with an anticipated generation capacity of 15 MW when solar panels are installed over 24 of the site's 49 hectares. According to Energex, the combined total generating capacity of rooftop solar PV installations on the Sunshine Coast is greater than 125MW (as at 2015). Combining the community's rooftop solar PV generation with the Sunshine Coast Solar Farm generation (125 MW + 15 MW) will mean that, by 2016, at least 140 MW of solar electricity generation will be located on the Sunshine Coast.

What happens to any surplus energy generated?

Any additional electricity generated at the solar farm will be exported back into the grid, thereby creating a potential revenue stream for council.

Updated August 2016

More information

Visit council's website and search, 'Sunshine Coast Solar Farm' or email council's Sunshine Coast Solar Farm Project Team
solarfarm@sunshinecoast.qld.gov.au.



www.fgadvisory.com

Large Scale Solar Feasibility Study

Victorian Greenhouse Alliances

FG Advisory

16th August 2017



Document Control

Large Scale Solar Feasibility Study

Issue Date 16th August 2017

Revision Number 4

Prepared by Rowan Gaze
Jake Hinton

Verified by Randy Gadiant
Luke Zha

Reviewed By Fran MacDonald (WAGA), David Meiklejohn (NAGA),
Scott McKenry (EAGA), Robert Law (CVGA), Heather
Phillips (WMSA)

Project Partners Central Victorian Greenhouse Alliance (CVGA)
Eastern Alliance for Greenhouse Action (EAGA)
Goulbourn Broken Greenhouse Alliance (GBGA)
Northern Alliance for Greenhouse Action (NAGA)
Western Alliance for Greenhouse Action (WAGA)
Wimmera Mallee Sustainability Alliance (WMSA)
Municipal Association of Victoria (MAV)

Disclaimer

All financial figures presented herein are based on cost opinions and are in conjunction with general estimation methods. Actual costs may vary.

Confidentiality

This document contains confidential information. All reasonable precautions should be taken to maintain confidentiality; to prevent unauthorised access to this document; and the disclosure of the material contained in this document.

Copyright

Copyright © 2017, FG Advisory Pty Ltd. All rights reserved. No part of this document may be reproduced or transmitted in any form or by any means without express written permission from FG Advisory Pty Ltd.

Official Minutes of Knox City Council

Key Terms

Term	Description
Business as Usual	Current energy procurement model. The baseline case.
kW	Kilowatt. A unit of power. 1,000W
LGC	Largescale generation certificates. One large-scale generation certificate is equal to one megawatt hour of eligible renewable electricity. Once created and validated, these certificates act as a form of currency and can be sold and transferred to other individuals and businesses at a negotiated price.
Mismatch	Proportion of energy that is consumed by Council/s at a different time to the solar array production.
MW	Megawatt. A unit of power equal to 1,000,000W
Net Present Value	The value in the present of a sum of money, in contrast to some future value it will have when it has been invested at compound interest.
Off-peak	Between 11:00pm – 7:00am Mon-Fri and Weekends.
Peak	Between 7:00am and 11:00pm Mon – Fri
Percent net renewable	The proportion of total consumption that can be met by renewable generation at any time.
Representative Council	Supplier of electricity consumption interval data used in modelling scenarios
Simple Payback	The length of time required to recover the cost of an investment
Solar Insolation	A measure of solar radiation energy received on a given surface area in a given time
100% Matched	Refers to a solar array sized such that all solar generation to be used at the Council's facilities within the same time period (i.e. No export).
100% Renewable	Refers to a solar array sized such that total yearly solar generation matches the Council's total annual consumption.

Table of Contents

1	Project Background.....	1
1.1	<i>Policy Context.....</i>	1
1.2	<i>Project Objectives</i>	1
2	Summary Recommendations	2
2.1	<i>Key Findings.....</i>	2
2.2	<i>Financial Summary.....</i>	2
2.3	<i>Recommended Scenario</i>	2
3	Methodology	3
3.1	<i>Project Development and Scope Identification.....</i>	3
3.2	<i>Scenario Modelling</i>	3
4	Preliminary Technical Feasibility Assessment	4
4.1	<i>Scenario Modelling Results.....</i>	4
4.2	<i>Scenario 1: Single Council (Battery Storage)</i>	5
4.3	<i>Scenario 2: Eight Councils (Site Location).....</i>	6
4.4	<i>Scenario 3: Eight Councils (Treatment of Large Scale Generation Certificates – LGC’s).....</i>	7
4.5	<i>Scenario 4: Seventeen Councils (Investment Model).....</i>	8
4.6	<i>Scenario 5: Seventeen Councils (Renewables Contribution)</i>	9
5	Key Considerations	10
5.1	<i>Grid Connection Requirements.....</i>	10
5.2	<i>Energy Fee Model</i>	10
5.3	<i>Procurement Model</i>	10
5.4	<i>Site Selection</i>	11
5.5	<i>Market Responsiveness</i>	11
5.6	<i>Economies of Scale</i>	11
6	Appendix.....	13
6.1	<i>Assumptions.....</i>	13
6.2	<i>Historical Development Costs – Array & Network Connection.....</i>	14
6.3	<i>Business as Usual Consumption Profiles and Scenario Consumption Scaling.....</i>	15
6.4	<i>Battery Storage Size Optimisation</i>	17
6.5	<i>Loan Period Sensitivity.....</i>	18
6.6	<i>Utility Rate Sensitivity.....</i>	18

1 Project Background

1.1 Policy Context

In response to rapidly escalating energy prices, FG Advisory were engaged by Victoria's Greenhouse Alliances to conduct an independent analysis of the costs and benefits for Victorian councils to invest, build, own and operate large scale renewable energy infrastructure to meet their long-term electricity needs.

This project follows from a discussion paper developed by the Victorian Greenhouse Alliances in May 2017, titled *Electricity Procurement in the Victorian Local Government Sector: Aligning Council Money with Council Values*. The discussion paper identified that direct investment in offsite renewable energy infrastructure and the purchase of renewable energy through a Power Purchase Agreement (PPA) as key opportunities for councils to address rising energy costs. Building on the outcomes of the discussion paper, this project examines the feasibility of councils investing in offsite generation infrastructure, and assesses the high-level costs and benefits of a range of investment scenarios and scales.

This initiative is designed to complement the emission reduction objectives of local governments across the State - 23 councils with corporate carbon neutral targets, 12 with carbon neutral targets for their communities, and 46 with percentage reduction targets. To date, these targets have been pursued through energy efficiency measures, including upgrades to public lighting and council buildings, and rooftop solar installations. Even with maximum energy efficiency and rooftop solar, however, there will remain an ongoing need to procure energy and take further action to meet emission reduction targets.

1.2 Project Objectives

The purpose of this Technical Feasibility Study is to examine the financial implications of a range of large scale solar infrastructure scenarios over their investment lifecycle. The five scenarios were collaboratively developed by the project partners to be meaningful and instructive to all Victorian councils. The scenarios are briefly described below:

1. Single Council for 7.8MW solar farm, located in Metropolitan Melbourne
 - a. With battery storage
 - b. Without battery storage
2. Eight Councils for a solar farm, located in either
 - a. Metro Melbourne (56.8MW)
 - b. Northwest VIC (46.8MW)
3. Eight Councils for 49MW solar farm, located in Northeast VIC
 - a. Sale of Large-scale Generation Certificates (LGC's)
 - b. Retirement of LGC's
4. Seventeen Councils for 88.4MW solar farm, located in Northern VIC²
 - a. Investment with cash (no finance)
 - b. Investment with debt (commercial finance)
5. Seventeen Councils for a solar farm, located in Northern VIC², sized for
 - a. 100% matched (19.0MW) - energy production matches Council instantaneous consumption
 - b. 100% renewable (88.4MW) - energy production offsets Council's annual consumption

To deliver an accurate evaluation of the Scenarios outlined above, the project objectives include the following:

1. Estimate infrastructure lifecycle costs for large scale solar (including cost of capital, maintenance, etc.).
2. Analyse the current energy consumption and load profile for one participating representative council, and scale based on aggregate consumption data given for each scenario.
3. Model solar farm generation output.
4. Develop a user friendly financial model that provides lifecycle cost analysis outputs.
5. Technical review of publicly available planning information such as solar resources, network planning and constraints, etc.

1. Victorian Greenhouse Alliances (2017) Discussion Paper: Electricity Procurement in the Victorian Local Government Sector.
 2. Location moved to Echuca because of likelihood of network capacity constraints in Mildura

2 Summary Recommendations

2.1 Key Findings

The feasibility study investigated a range of scenarios for councils to invest in, own and operate large scale solar infrastructure. The most feasible option for councils is a 100% renewable-sized solar farm located in the Northern VIC region, using low interest finance and selling all LGCs, providing an NPV of \$1.7M per council.

2.1.1 Scenario Modelling Outcomes

In developing the most financially attractive option, the following scenario model outputs should be incorporated as guidance for any future project development:

1. **Battery Storage:** The exclusion of batteries provides a higher financial return than including batteries
2. **Location:** The NW VIC location provides a higher financial return than installation in Metro Melbourne
3. **LGC Treatment:** The sale of LGCs provides a higher financial return than retiring LGCs
4. **Investment:** Low interest finance provides a higher financial return than direct investment
5. **Contribution:** 100% Renewables provides a higher financial return than 100% Matched Energy

Net Present Value (NPV) was adopted as a standardised measure to evaluate the financial return of each scenario. NPV represents the total financial return of the project over a 25-year investment period.

2.2 Financial Summary

The solar array size, capital cost, simple payback, and Net Present Value are presented below for each scenario, demonstrating the overall financial attractiveness of each scenario over a 25-year period. Scenario 4B provides the most attractive Net Present Value.

Scenario	Scenario Description	# of Councils	Array Size (MW)	Capital Cost (\$M)	Simple Payback Period (Years)	Net Present Value (25Y)	Net Present Value (Per Council)
1A	Battery Storage: None	1	7.8	\$19.5 M	28.6	-\$2.1 M	-\$2.1 M
1B	Battery Storage: 13 MWh	1	7.8	\$45.5 M	87.9	-\$29.9 M	-\$29.9 M
2A	Location: Melbourne	8	56.8	\$141.9 M	28.6	-\$15.6 M	-\$1.9 M
2B	Location: NW VIC	8	46.8	\$117.0 M	21.1	\$13.7 M	\$1.7 M
3A	LGC Treatment: Sell	8	49.0	\$122.5 M	22.8	\$7.0 M	\$0.9 M
3B	LGC Treatment: Retire	8	49.0	\$122.5 M	29.6	-\$18.0 M	-\$2.3 M
4A	Investment: Direct Invest	17	88.4	\$221.0 M	22.2	\$17.0 M	\$1.0 M
4B	Investment: Finance	17	88.4	\$221.0 M	N/A	\$28.9 M	\$1.7 M
5A	Contribution: 100% Matching	17	19.0	\$47.5 M	27.5	-\$3.9 M	-\$0.2 M
5B	Contribution: 100% Renewables	17	88.4	\$221.0 M	22.2	\$17.0 M	\$1.0 M

Table 1: Financial Summary for all scenarios modelled.

2.3 Recommended Scenario

Scenario 4B: Low Interest Finance presented the most financially attractive scenario, resulting in a Net Present Value of \$28.9 M. Scenario 4B incorporates the following input variables:

- Number of Councils: 17
- Battery Storage: None
- Location: Northern Victoria
- LGC Treatment: Sell LGCs
- Investment: Low Interest Finance (3.97%)
- Contribution: 100% Net Renewables

- Does not include costs of land procurement or network improvements.

3 Methodology

FGA employed the following methodology to meet the intended project outcomes.

3.1 Project Development and Scope Identification

At project inception, FGA facilitated a workshop with key project working group stakeholders to understand the project requirements, including:

Project Briefing and Ongoing Consultations

- Briefing on the project background and context
- Discussion on the Scenarios to be modelled, and any identified risks and issues and their mitigation measures
- Key financial assumptions required for material cost components that underpin the lifecycle Finance Model

3.2 Scenario Modelling

Based on the defined Scenarios, FGA conducted data review and technical analyses for the identified large scale solar investments.

Energy Data and Scaling

Each Scenario uses a different scaling of the Representative Council's energy consumption interval data at hourly intervals.

- Scenario 1 is a single Council, and is therefore not scaled.
- Scenarios 2 and 3 comprise 8 separate Councils, and scales the Representative Council interval data to match actual consumption data of the metro alliance.
- Scenarios 4 and 5 are a composition of 17 Councils, and scale the Representative Council data to match total annual consumption for all 17 Councils based on data from the MAV procurement group.

The interval energy database provides the foundation to create energy profiles showing variations in electricity consumption (measured in kWh) over time.

See Section 6.2 for further details on energy consumption data used, and relative scaling for each Scenario.

Solar Data Sources

Solar modelling is based on hourly average insolation data (solar energy received per square meter per month) for each month from the Bureau of Meteorology over the last 15 years for locations dependent upon the Scenario:

- Scenarios 1 & 2A utilise Melbourne insolation data
- Scenario 2B utilises Swan Hill insolation data
- Scenario 3 utilises Shepperton insolation data (Hume)
- Scenarios 4 and 5 utilise Echuca insolation data

Energy and Solar Feasibility Modelling

- Using energy engineering techniques, a model to visually illustrate the combined electricity consumption profile for each Scenario was constructed. This baseline model represents the business-as-usual (BAU) condition, and provides a basis for comparison to modelled Scenarios
- A technical solar farm feasibility model for each Scenario was developed, providing overlay of power generation profiles for comparison with existing energy consumption data.

Large Scale Solar Financial Model

- FGA provided a user-friendly Solar Farm Financial Model, providing lifecycle cost analysis outputs based on various user-adjustable inputs.

4 Preliminary Technical Feasibility Assessment

FGA presents the following detailed energy modelling results for each scenario. Note that Mismatch* refers to the proportion of solar energy generated at times when it does not match the aggregated electricity consumption profile. A low value of mismatch implies a large proportion of the Council's energy consumption occurs at times when solar arrays are producing energy. A high mismatch implies the majority of the Council's energy consumption occurs at times when the solar arrays are not producing energy. All assumptions utilised in modelling are summarised in Section 6.1.

4.1 Scenario Modelling Results

Scenario	Scenario Description	# of Councils	Array Size (MW)	Land Area Required (ha)	Generation (GWh)	Mismatch* (%)	% Net Renewable	Annual Savings (\$M)	Total LGC Revenue (\$M)	Capital Cost (\$M)	Simple Payback Period (Years)	NPV (\$M)	NPV (per Council) (\$M)
1A	Battery Storage: None	1	7.8	23.7	11.4	67%	100 %	\$0.70	\$3.4	\$19.5	28.6	-\$2.1	-\$2.1
1B	Battery Storage: 13 MWh	1	7.8	23.7	11.4	30%	100 %	\$0.62	\$3.9	\$45.5	87.9	-\$29.9	-\$29.9
2A	Location: Melbourne	8	56.8	172.4	82.6	67%	100 %	\$5.11	\$28.4	\$141.9	28.6	-\$15.6	-\$1.9
2B	Location: NW VIC	8	46.8	142.0	82.6	67%	100 %	\$5.13	\$28.4	\$117.0	21.1	\$13.7	\$1.7
3A	LGC Treatment: Sell	8	49.0	148.7	82.6	67%	100 %	\$5.12	\$28.4	\$122.5	22.8	\$7.0	\$0.9
3B	LGC Treatment: Retire	8	49.0	148.7	82.6	67%	100 %	\$5.12	\$0	\$122.5	29.6	-\$18.0	-\$2.3
4A	Investment: Direct Invest	17	88.4	268.2	151.2	67%	100 %	\$9.39	\$51.9	\$221.0	22.2	\$17.0	\$1.0
4B	Investment: Finance	17	88.4	268.2	151.2	67%	100 %	\$9.39	\$51.9	\$221.0	N/A	\$28.9	\$1.7
5A	Contribution: 100% Matching	17	19.0	57.6	32.5	2.3%	22 %	\$1.70	\$11.2	\$47.5	27.5	-\$3.9	-\$0.2
5B	Contribution: 100% Renewables	17	88.4	268.2	151.2	67%	100 %	\$9.39	\$51.9	\$221.0	22.2	\$17.0	\$1.0

Table 2: Detailed Scenario Modelling results for Large Scale Solar

4.2 Scenario 1: Single Council (Battery Storage)

4.2.1 Scenario Overview

Scenario 1 considers the financial implications of large scale battery storage incorporated into the solar array. In general, battery storage allows for excess solar energy generated during the day to be stored and used during the night, when solar generation is unavailable.

The battery storage system is sized for 13,000kWh to optimise the balance between percentage mismatch and simple payback period (see Section 6.4 for additional details regarding battery size optimisation).

4.2.2 Technical Analysis

The graphs below outline the existing load (grey), proposed solar PV generation (orange) and the net remaining grid load required after the addition of solar (green) and battery storage (yellow). The net grid load is shown to outline the level of mismatch occurring in each scenario.

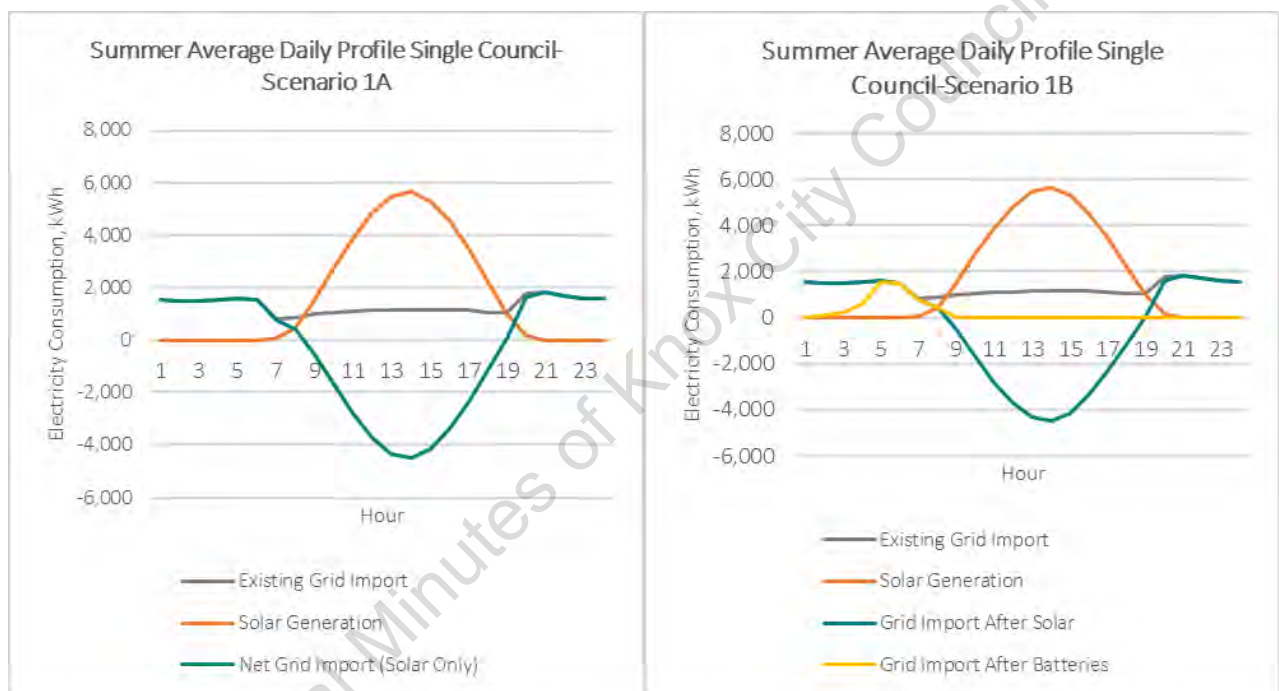

Figure 1: Average daily electricity consumption for single Council with solar and batteries included

4.2.3 Commentary

- **The addition of battery storage is not recommended**
- The addition of battery storage reduces project net present value.
- The 13,000 kWh battery reduces mismatch from 67% to 30%
- High export rates (approximately 0.05 \$/kWh) and low off-peak rates (approximately 0.04 \$/kWh) in energy modelling result in a reduction in savings from batteries, as compared to exporting excess solar energy
- The financial benefits of batteries are modelled assuming energy savings and maximum demand reductions only. Financial benefits of batteries due to network support, and other network benefits are not considered.

4.3 Scenario 2: Eight Councils (Site Location)

4.3.1 Scenario Overview

Scenario 2 considers the financial implications of solar farm location, by comparing large scale solar in Swan Hill and Melbourne. Scenario 2 also considers eight Councils involved in the project.

In general, areas with greater solar insolation are more favourable locations for solar arrays. Factors such as grid connection capability, environmental degradation, and sourcing spare parts and labour to remote areas also should be considered. Indeed, development of large scale solar in a location such as Mildura would require extensive network upgrades and hence costs, due to zero current capacity. Solar insolation data used in energy modelling was sourced from the Bureau of Meteorology.

4.3.2 Technical Analysis

Figure 2 below compares the solar insolation received, in kilowatt hours per square meter, for the Swan Hill (orange) and Melbourne (teal) locations. As consequence of the higher insolation in Swan Hill, a 46.8 MW solar array in Swan Hill will produce the equivalent solar energy output as a 56.8 MW solar array in Melbourne. The budget capital cost for each system is outlined in Figure 3.

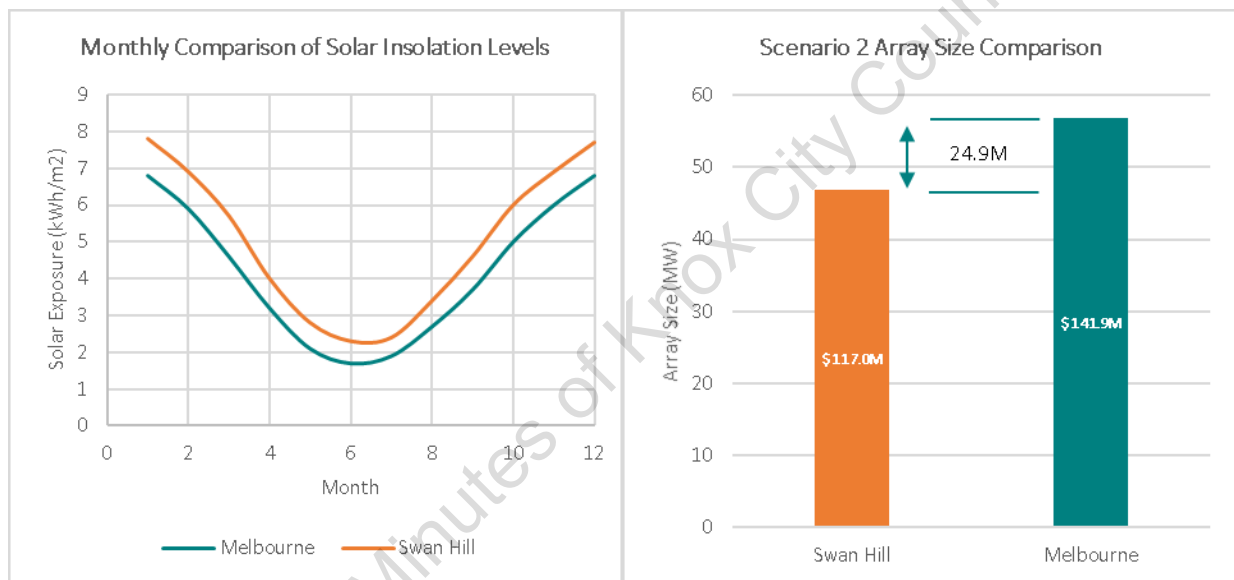

Figure 2: Comparison of monthly solar irradiation levels between Melbourne and Swan Hill

Figure 3: Size/cost comparison of solar array in Melbourne and Swan Hill

4.3.3 Commentary

- The location of solar in Swan Hill is recommended over the location of solar in Melbourne
- A solar array located in Swan Hill produces more electricity than the equivalent array in Melbourne
- On average, Swan Hill receives 23% more solar radiation per month compared to Melbourne
- For large scale solar farms, Councils are advised to seek development locations in areas that experience more sun hours, particularly NE and NW regions of Victoria

4.4 Scenario 3: Eight Councils (Treatment of Large Scale Generation Certificates – LGC's)

4.4.1 Scenario Overview

Scenario 3 considers the financial implications of LGC treatment, comparing the benefits of selling LGCs against retiring LGCs. The sale of LGC's provides an annual revenue stream for Council. In this case, LGC revenues are calculated assuming an initial price of \$80/LGC, and a lifetime of only five years, due to uncertainty in the future of the Renewable Energy Target.

The Scenario 3 modelled a solar array located in the Hume region. The output from this array is designed to match annual energy consumption of the eight representative Councils.

4.4.2 Technical Analysis

The Figure below outlines the lifecycle cash flow of LGC revenue for both Scenario 3A & 3B. Both payback and final net cash position are more positive in the sale of LGC scenario.

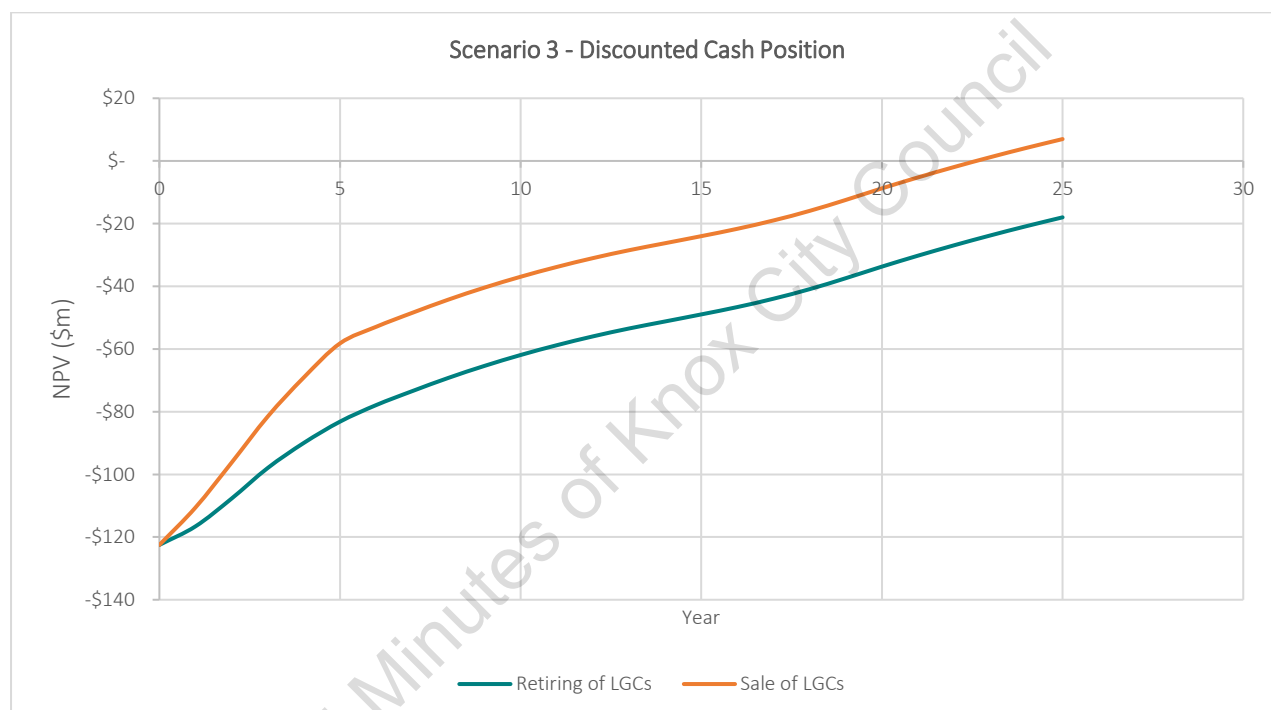

Figure 4: Effect of LGC sale and retirement on discounted net cash position

4.4.3 Commentary

- **The sale of LGC's is recommended over retiring LGCs based on substantial financial benefits**
- The sale of LGC's represents approximately \$25M in additional NPV over the retire LGC scenario.
- The sale of LGCs reduces Simple Payback period by over five years
- LGCs have been modelled with a 5-year lifetime, a starting price of \$80 per LGC and a 5% annual degradation in value over 5 years. For the remaining 20 years, LGC revenue is assumed to be \$0.
- If a Council chose to sell its LGCs, it cannot claim the associated emission reduction, however it can still claim that it is supporting renewable energy

4.5 Scenario 4: Seventeen Councils (Investment Model)

4.5.1 Scenario Overview

Scenario 4 considers the implications of various investment options for the initial capital required. The two Scenarios in consideration are a direct cash investment and a low interest, 25-year loan. The loan was modelled as having a fixed interest rate of 3.97% for 25 years.

Note that the location for this modelled scenario has been changed from Mildura to Echuca. This is based on feedback from the WMSA, citing preliminary advice from the Network Authority (Powercor) that there will likely be capacity constraints for new renewable energy projects in the Wimmera Mallee region without further network augmentation.

FGA advises that region selections are for modelling and budget purposes only. Further consultation and detailed assessments for Authority Approvals are required during the detailed design stage.

4.5.2 Technical Analysis

The Figure below outlines the discounted cash position over the 25-year lifetime of the project. The loan term is assumed to be 25 years with an interest rate change of 3.97%. The loan repayments include interest and principal.

The Direct cash investment scenario presents a negative cash flow for the majority of the project. Financing the project with low interest debt ensures that the financial energy savings (including sale of LGCs) outweighs the principle and interest payments on the low interest loan, resulting in a net positive cash flow investment.

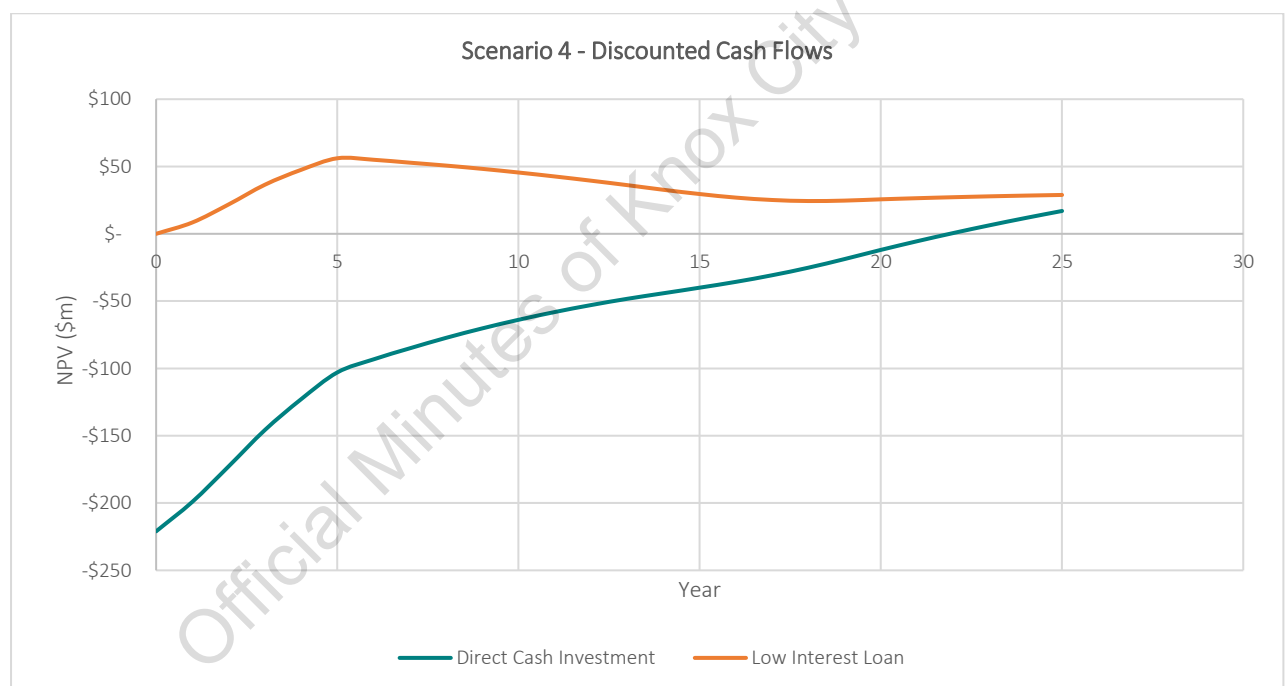

Figure 5: Aggregate discounted cash flow comparison between cash investment and low interest loan

4.5.3 Commentary

- **The use of low interest finance is recommended over a direct cash investment**
- The NPV of the Debt Scenario is higher than the direct investment Scenario over the project's lifecycle
- The NPV for the Debt Scenario is \$28.9 M, compared to \$17.0 M for the direct investment model
- Loan repayments and interest details
 - Constant loan repayments of \$14.1 M (principal + interest) per annum for a loan term of 25-years
 - Total interest of \$131.5 M over 25-year loan term
- Direct Investment details
 - Upfront capital investment is \$221.0M for an 88.4 MW array.
- The NPV increase in the first 5 years for both models is due to LGC revenues

4.6 Scenario 5: Seventeen Councils (Renewables Contribution)

4.6.1 Scenario Overview

Scenario 5 considers the financial implications of sizing the solar array for 100% Net Renewable or 100% matched consumption and production. This scenario is evaluated over seventeen Councils. Mismatched energy represents the proportion of solar energy generated at times when it does not match the combined Council electricity consumption profile.

Scenario 5 considers an 19MW solar array located in north Victoria (Echuca) designed for all solar generation to be used at the Council's facilities within the same period, termed '100% Matched'. It is compared with an 88.4 MW array located in Echuca that is designed to match total annual consumption, termed '100% Net Renewable'.

4.6.2 Technical Analysis

The graphs below outline the modelled solar PV production output for Scenarios 5A & 5B. The *100% Net Renewable* scenario requires greater solar generation during the day to offset off-peak loads at night. The *100% Matched* Scenario requires that all solar energy generation is consumed by Council. These scenarios are presented graphically below.

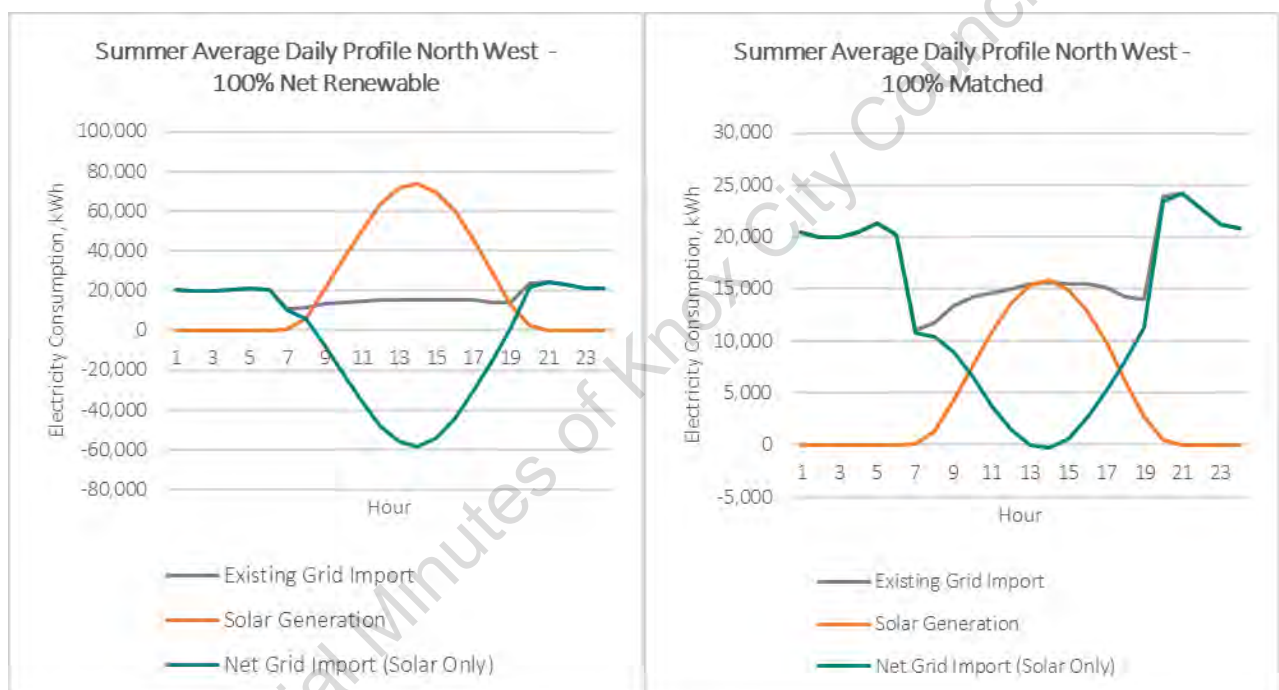

Figure 6: Daily load profiles of 17 Councils with solar arrays sized to '100% Net Renewable' (left) and '100% Matched' (right)

4.6.3 Commentary

- **The provision of 100% renewable energy is recommended over 100% matched**
- The 100% Renewable energy scenario presents a more positive NPV than the 100% Matched Scenario
- The financial model assumption that export rate (spot market price for export) is higher than the off-peak rate results in solar production during the day being more financially beneficial than off peak consumption of energy.
- Management fees for the Retailer to firm and shape the output of the solar array have not been included. Should Council wish to pay a fee for the Operation and Management of the Array and the energy production, the cost of the 100% Renewable Scenario will increase.
- Modelling is based on historical pricing, which may not be an accurate reflection of future prices.

5 Key Considerations

The following considerations are out of scope for this Feasibility Study, but are noted as requirements for further detailed design development:

5.1 Grid Connection Requirements

All grid connected (i.e. not off-grid) renewable energy installations require Authority approval prior to connection.

Typically, solar farms with capacities over 1MW are connected to the electricity network at high voltage (22kV) within the distribution network, sub-transmission lines (66kV), or transmission lines (>66kV). Connections at this size present potential risks to network stability, safety, power quality and reliability of supply to customers.

During the detailed design phase, the relevant Distribution Network Service Provider (DNSP) should be consulted and presented with technical design information sufficient to commence the formal review and approval process. The first step in the approval process for most DNSPs is to submit a Preliminary Enquiry application with supporting technical design documentation.

The connection process is expected to require extensive technical/engineering support, and commercial and legal advisory, and may incur additional costs for the completion of network studies and/or augmentation works by the DNSP.

The processes for network connection varies depending on the DNSP. The connection process for large scale generation (over 5MW) can vary substantially depending on the DNSP, location of the site, and the relevant network constraints to that site. The Australian Energy Market Operator will also require consultation and engineering services fees for any site over 5 MW in capacity.

A high-level overview of the network capacity in each region can be found on the Distributed Annual Planning Reports for each Distributor. Ausnet Services can be found here: <https://www.ausnetservices.com.au/Misc-Pages/Links/About-Us/Publications>

Should sufficient network capacity be available, the proximity to transmission & distribution infrastructure will impact the cost of the network connection. Costs are outlined from Powercor as follows:

Item	Location	Cost
22 kV Overhead (OH) extension	Rural/Regional	\$0.2 M per km
22 kV Underground (UG) extension	Rural/Regional	\$0.9 M per km
66 kV OH extension	Rural/Regional	\$0.3 M per km
66 kV UG extension	Rural/Regional	\$1.2 M per km
66 kV Switching Station	Rural/Regional	\$5.0 M each

Table 3: Network extension costs in Powercor network (Powercor, 2017)¹

5.2 Energy Fee Model

A grid connected solar array will require a new financial agreement between investor councils and the retailer. Current modelling assumes energy rates as per assumptions provided in Section 6.

5.3 Procurement Model

A comparison of a direct investment to a power purchase agreement is highly recommended (See Victorian Greenhouse Alliance's *Electricity Procurement in the Victorian Local Government Sector: Aligning Council Money with Council Values*).

1. <https://www.powercor.com.au/our-services/electricity-connections/solar-and-other-generation/connecting-larger-embedded-generator-systems/>
 2. <https://www.cleanenergycouncil.org.au/policy-advocacy/reports/clean-energy-australia-report.html>

5.4 Site Selection

Value and capital costs associated with land are not contained within the scope of this report. Future detailed site selection should consider the follow factors:

- Local solar irradiance levels - as described previously.
- Land availability/area - see Table 2 for a summary of land size required for all arrays. Land costs are significantly more expensive closer to Melbourne's CBD than in regional areas. Land value and land acquisition has not been included in modelling to this point. All sites are assumed to be on Council owned land. Should Council's require further land then these costs will be additional to modelling undertaken in this report. Median values for land prices in Victoria are outlined below:
 - NW Victoria - \$1,700 / ha
 - SW Victoria - \$5,000 / ha
 - Northern Victoria - \$5,000 / ha
 - Gippsland - \$9,100 / ha
 - Values are median farmland sales published in May 2016¹
- Land value – where councils hold existing land, comparing the value in other investment areas, i.e. housing, is necessary.
- Proximity to electricity transmission network
- Proximity to local township – due to local employment benefits and electricity demand requirements.

5.5 Market Responsiveness

The market for small scale solar arrays below 5 MW and above 50 MW is currently more attractive to developers and installers. Below 5 MW, regulatory requirements are lower and connections completed quicker. Above 50 MW the regulatory burden becomes a lower proportion of total project cost and time and is an acceptable risk for developers and installers to commit to.

5.6 Economies of Scale

Solar arrays are typically grouped by size category into residential (1-10 kW), commercial (10-200 kW) and utility or large scale above 200 kW. As noted in the graph below, the cost of large scale solar is not predictably follow an economies of scale curve. It is more instructive to provide a range of expected prices for large scale solar, ranging from \$1.34/W to \$4.00/W. The large variance in cost is due to numerous factors; namely integration to the electricity network.

The cost of panels, inverters, and mounting hardware is relatively stable for large scale solar, and great cost efficiencies are not guaranteed by exploring larger scale projects. As such, the NPV per council is equal whether an array is sized to match the generation of 8 councils or 17 councils, given all other variables equate. The green horizontal line in the Figure below outlines the \$2.50/W value assumed in FGA's modelling across all Scenarios.

5.6.1 Total Project Costs (excluding land acquisition)

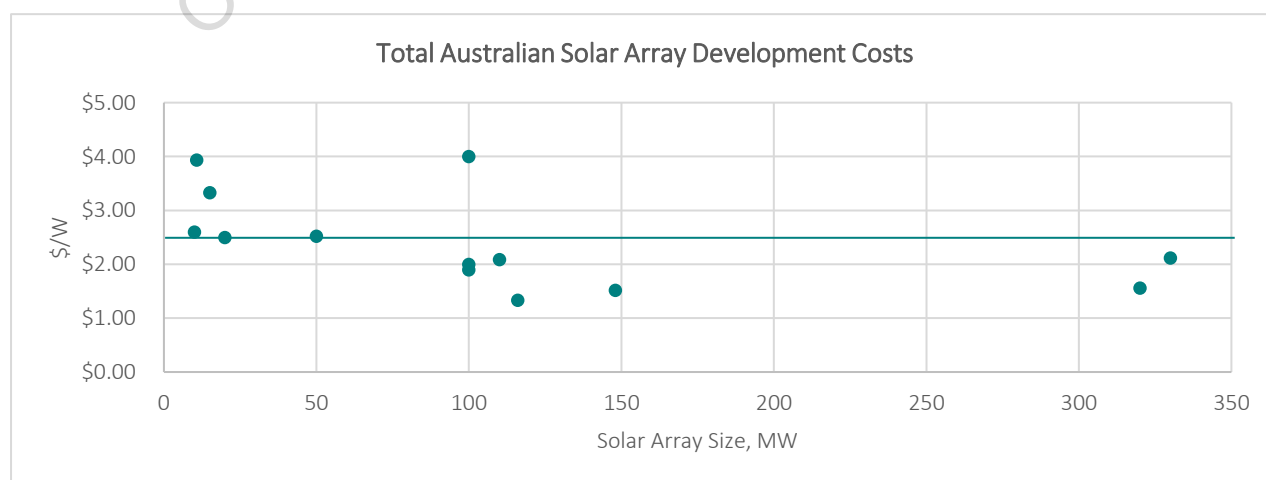

Figure 7: Summary of project costs per watt of installed capacity (Data adapted from CEC, 2017² see Appendix for raw data)

5.6.2 Technology Costs

The declining cost of solar PV modules have significantly reduced capital costs for equipment in recent years. Government programs and market competitiveness have also placed downward pressure on prices. The cost of solar PV equipment and developments are currently favourable for large scale installations. Financial viability is to be revised should the following occur: Government subsidies cease or be reduced, land availability decreases and/or favourable grid connection locations are developed.

The cost of battery storage currently does not offer a viable amount of savings in energy for further development at this stage. In the future, installed costs of large scale batteries are expected to decrease. Alternative funding arrangements are also expected to be available with DNSP's and State Government contributions. Battery storage financial viability should be reassessed in line with expected network changes to incorporate large-scale battery installations.

5.6.3 Additional Indirect Costs

Further cost considerations include planning, soil testing and legal fees. Planning requirements can create costs due to the engagement for an independent planner and the scrutiny received for any developments in the planning system.

Soil testing has been included in overall project costs by kW. Extensive soil testing for large arrays can increase indirect costs outside the contract as tenderers require more information prior to submitting their proposals.

Legal fees can be incurred when creating new solar PV design and construct contracts for large arrays, and to create the agreement between Retailer and Corporate offtake to sell the energy from the solar PV array.

6 Appendix

6.1 Assumptions

Scenario Assumptions

- Interval data at 15 minute intervals for a single ‘representative Council’, located in Metropolitan Melbourne
- Three types of site profiles were included: public lighting, large market sites, and small market sites
- Scenario 1 utilises only representative Council interval data
- Scenario 2 & 3 consists of representative Council profile scaled to yearly consumption of 8 Councils
- Scenario 4 & 5 consist of representative Council profile scaled to yearly consumption of 17 Councils.

Solar PV Array Physical Assumptions

- Solar PV array production assumes:
 - 260 Wp modules of 17.75% efficiency
 - Standard efficiency (98%) inverters with no tracking or string DC optimisation
 - Total system efficiency of 82%. Loss factors include manufacturer’s testing tolerance, temperature losses, voltage drop, yearly degradation and transformer losses.
 - Modules arranged in double rows of tilt framing to 30° with 3.5 m row spacing.
 - Solar insolation data gathered from Bureau of Meteorology for Melbourne, Swan Hill, Shepparton (Hume Region) and Echuca (North-west region). Note the location change from Mildura to Echuca due to the likelihood of network capacity constraints.

Financial Assumptions

- All scenarios assume the following:
 - Year 0 energy tariff blended across large, small and public lighting markets rates.
 - Peak: \$0.0583 /kWh
 - Off-Peak \$0.0379 / kWh
 - An annual electricity tariff escalation based on Jacob’s/AEMO Victoria Index forecasted over 25 years
 - Network tariffs not considered, as all energy requires distribution through network regardless of location of new renewable facility.
 - Total capital cost of solar PV array assumes \$2,500 per kWp of installed capacity (kWp of modules installed (DC)).
 - Battery cost assumed at \$2,000 per kWh
 - Cost of land is not considered
 - After the installation of the large scale renewable facility, there are three flows of energy.
 1. Renewable energy produced from solar PV and consumed by Council sites at the same time (“matched”). This energy is assumed to be obtained from the renewable energy plant, and therefore will be obtained at no cost.
 2. Energy consumed by Council sites at times when there is no renewable energy production (“mismatch”). This energy is assumed to be purchased at the existing wholesale tariff blended from large, small and public lighting accounts.
 3. Renewable energy produced by solar PV and consumed elsewhere in the grid. This energy is assumed to be sold at the spot market price.
 - Value of large scale generation certificates (LGC’s) is \$80/LGC at Year 1, and is modelled to decline over the next five years at 5% per annum. LGC’s assume to have no value after five years due to uncertainty in the Renewable Energy Target (RET).
 - Annual operation and maintenance (O & M) costs assumed at \$20/kW installed.
 - NPV Assumptions
 - 25-year investment timeframe
 - Discount rate of 4.5%
 - 25-year asset life

6.2 Historical Development Costs – Array & Network Connection

6.2.1 Large Scale Solar Farms (CEC,2017) ¹

The following Table presents a list of recently installed large scale solar farms in Australia. Costs are total project costs including network connections.

State	Developer	Project	MW	Investment	\$/W
QLD	Sunshine Coast Council	Sunshine Coast Solar Farm	15	\$50m	\$3.33
QLD	Lakeland Solar & Storage	Lakeland Solar & Storage	10.8	\$42.5m	\$3.94
NSW	New Gullen Range Wind Farm	Gullen Range Solar Farm	10	\$26m	\$2.60
QLD	Fotowatio Renewable Ventures	Lilyvale Solar Farm	100	\$400m	\$4.00
NSW	Neoen	Dubbo, Parkes, Griffith	110	\$230m	\$2.09
QLD	ESCO Pacific	Ross River Solar Farm	148	\$225m	\$1.52
SA	Snowy Hydro	Tailem Bend	100	\$200m	\$2.00
QLD	Fotowatio Renewable Ventures	Clare Solar Farm	100	\$190m	\$1.90
QLD	Sun Metal P/L	Sun Metals Solar Farm	116	\$155m	\$1.34
QLD	Genex	Kidston Solar Farm	50	\$126m	\$2.52
WA	APA	Emu Downs	20	\$50m	\$2.50
VIC	Overland Sun Farming	Yatpool, Iraak, Wemen	320	\$500m	\$1.56
SA	Lyon Group	Riverland Solar Farm	330	\$700m	\$2.12

Table 4: Summary of Large Scale Solar Installations, adapted from CEC Clean Energy Australia Report (2017)

6.3 Business as Usual Consumption Profiles and Scenario Consumption Scaling

The graphs below show the existing monthly consumption profiles for the representative single Council (Figure 8) Eight Councils (Figure 9), and the 17 Councils (Figure 10). A monthly profile is adopted to demonstrate the monthly variance in energy consumption.

Scenario 1

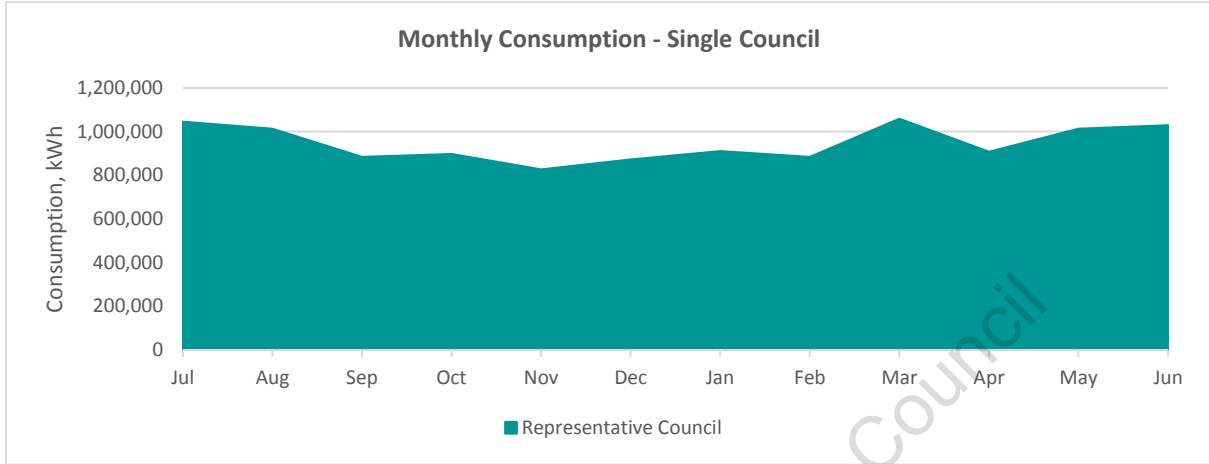

Figure 8: Annual load profile for representative Council.

Scenario 2 & 3

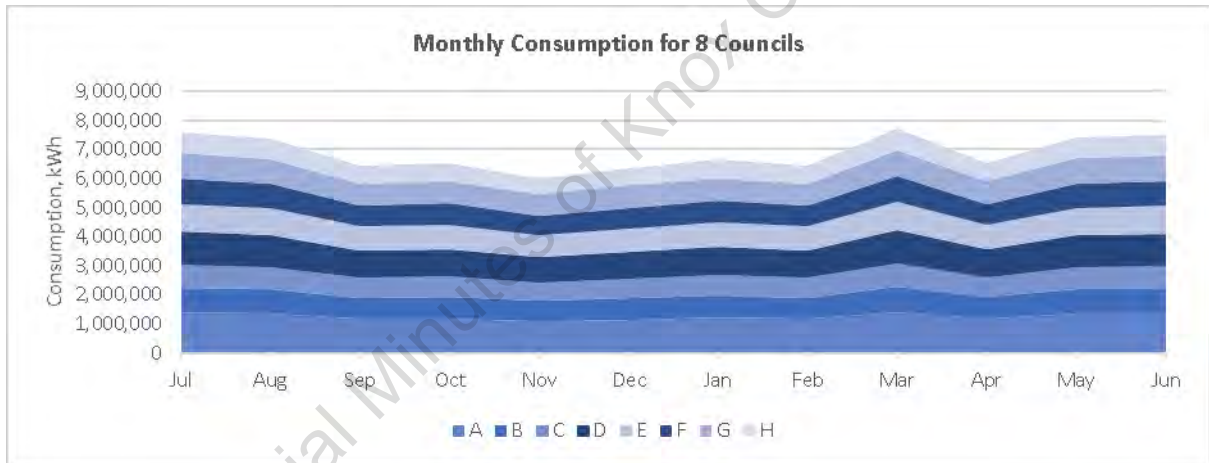

Figure 9: Annual load profile for 8 Councils (scaled from Single Council).

Scenario 4 & 5

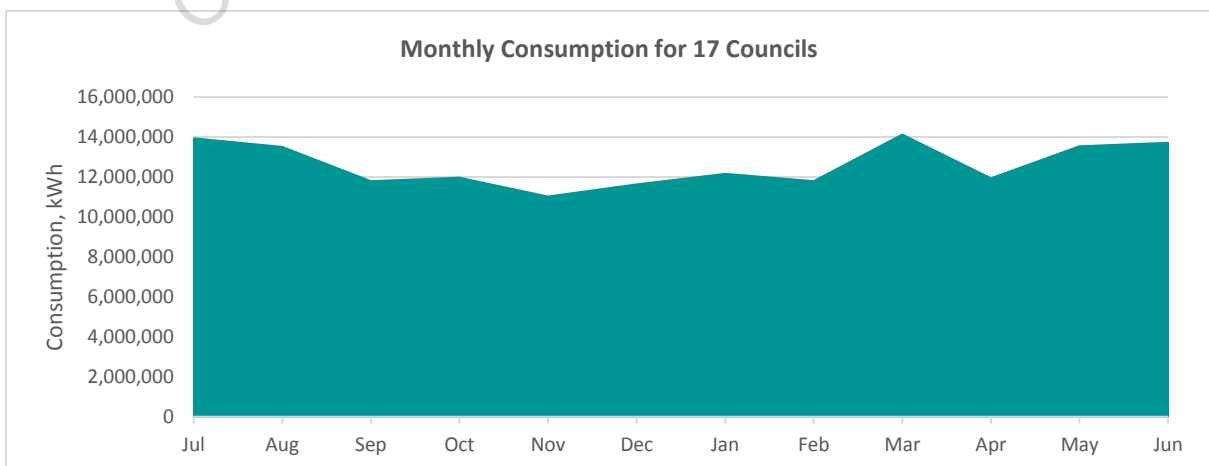

Figure 10: Annual load profile for 17 Councils (scaled from Single Council).

Some key observations associated with the current single Council electricity consumption profile are summarised below:

Commentary

- In aggregate, the representative Council exhibits moderate seasonal variation, ranging from approximately 800 MWh in November, to as high as 1,100 MWh in March.
- The moderate seasonal variance can be attributed to the large market sites, which tend to have higher electricity consumption profiles in winter months
- The high baseline and moderation of variability can be attributed to the large contribution of public lighting to overall consumption, which is a constant throughout the year.

6.3.1 Business as Usual Daily Electricity Consumption Profiles

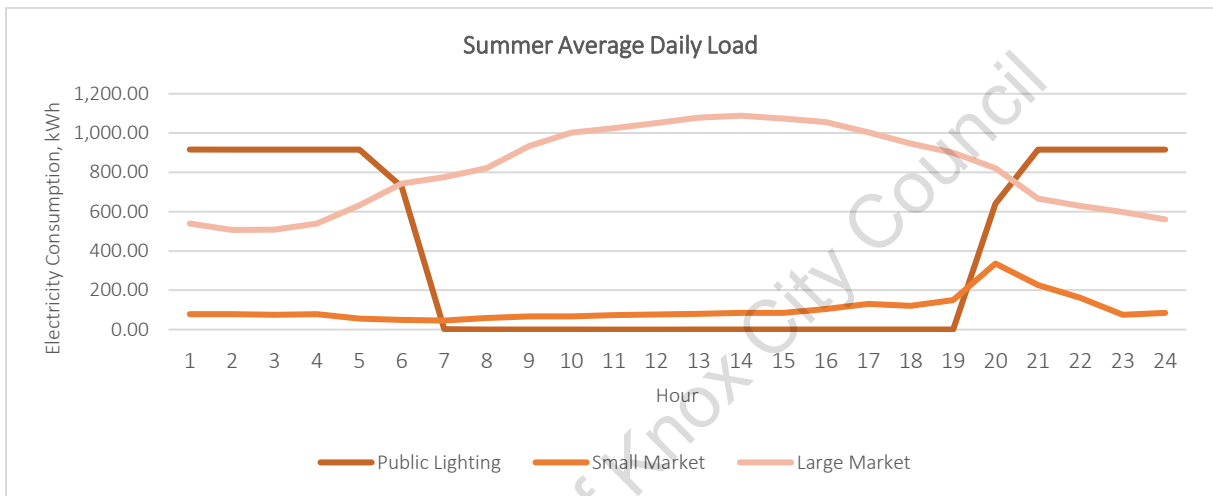

Figure 11: Daily summer load profile for Representative Council

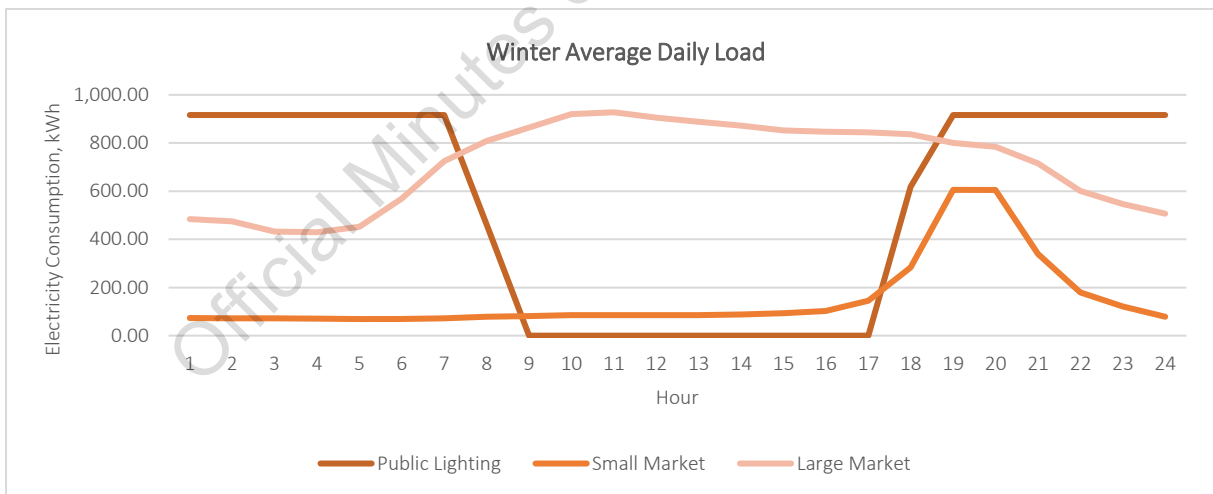

Figure 12: Daily winter load profile for Representative Council

Commentary

- Seasonal effects are representative of the small market winter peak at 7pm, typical of increased after-hours use
- Public lighting accounts for large off-peak electricity usage throughout the year, which results in a large mismatch compared to solar generation
- Summer daily load is, on average, higher than in winter

6.3.2 Scaling Composition Comparison

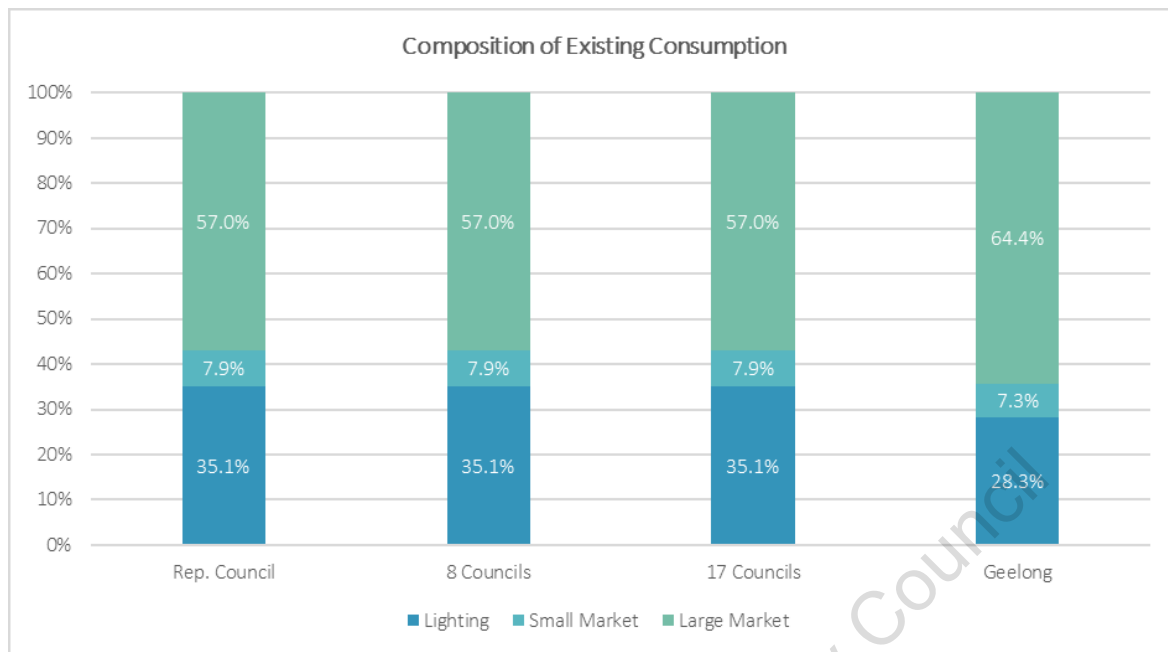

Figure 13: Comparison of load profile components

Commentary

- The Eight Council and 17 Council Scenarios were scaled directly from the Representative Council data provided
- City of Greater Geelong Council data used for comparison purposes with Representative Council data provided (this is a publicly available dataset)
- City of Greater Geelong small market, large market, and public lighting consumption split is generally consistent with the Representative Council data provided

6.4 Battery Storage Size Optimisation

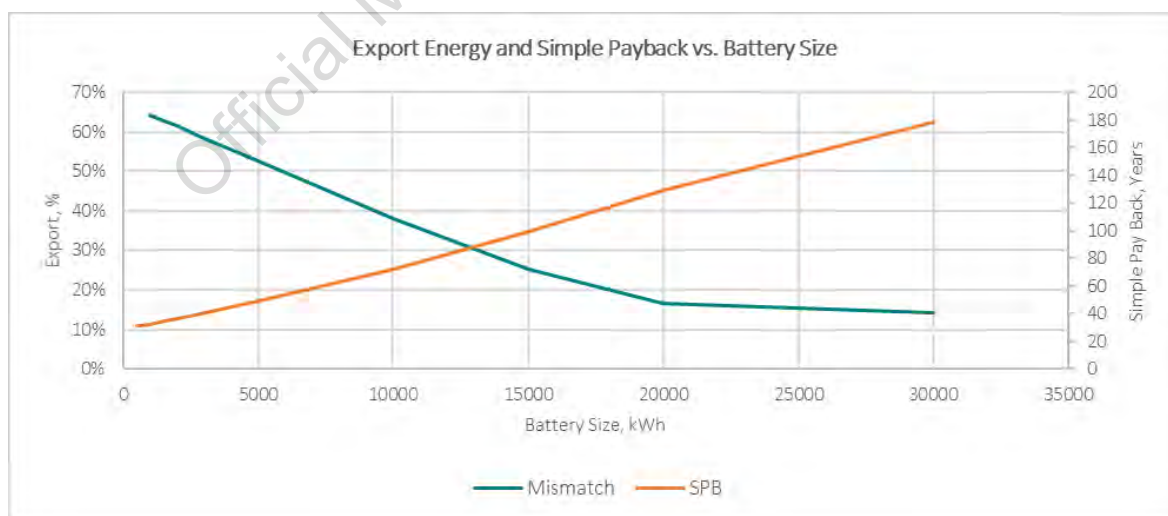

Figure 14: Optimisation of export % with SPB (Scenario 1b)

A 13,000kWh battery storage provides the optimal balance between minimising mismatch and simple payback period. Note that the addition of battery storage significantly inflates simple payback period values. The battery storage system was sized in accordance with Scenario 1B.

6.5 Loan Period Sensitivity

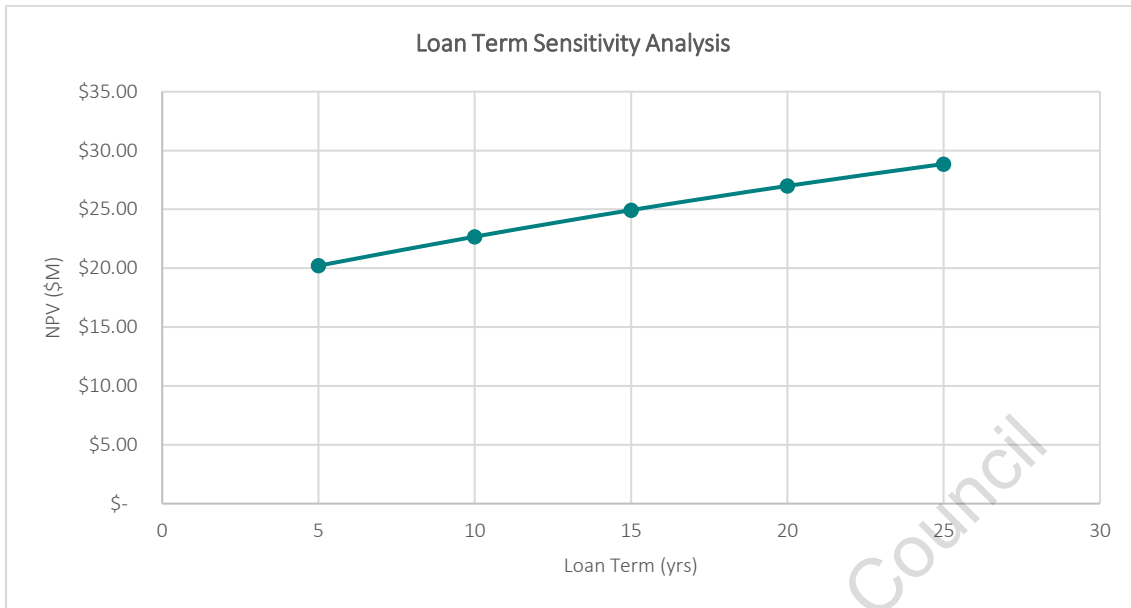

Figure 15: Effects of loan term on NPV (Scenario 4b)

Modelled NPV increases with loan term length. Loan conditions were:

- 0% down payment
- Initial interest rate of 3.97% for 25 years
- No residual amount owing at the end of the loan term

6.6 Utility Rate Sensitivity

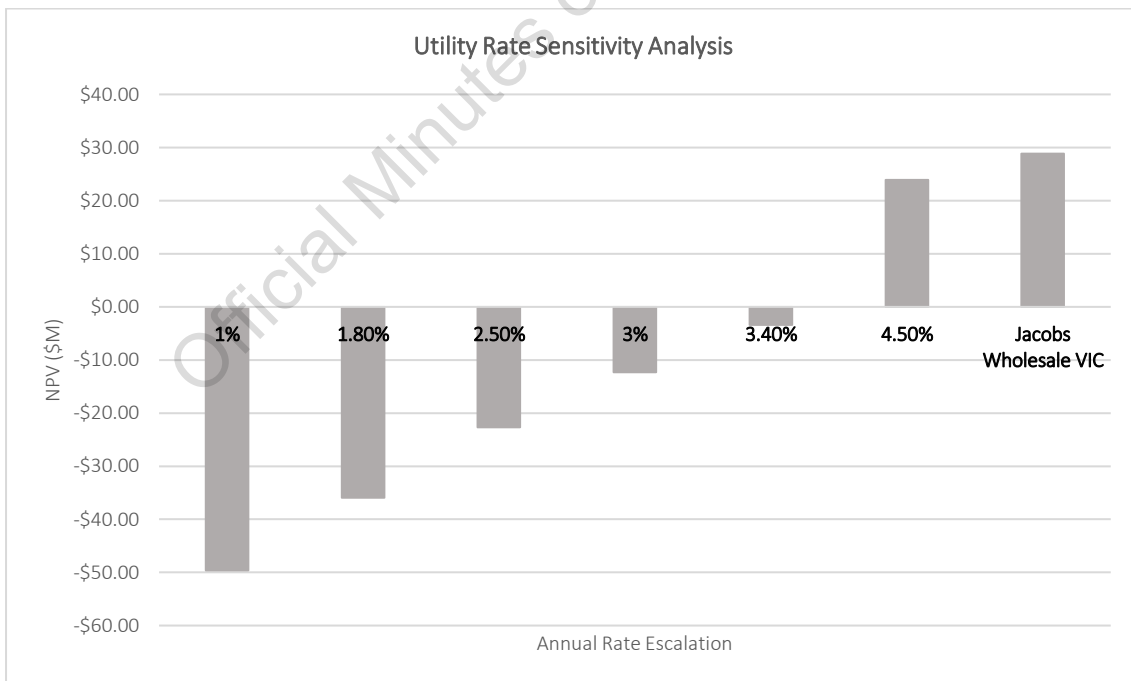

Figure 16: Effect of utility rate on NPV (Scenario 4b)

Modelled Scenario NPV is highly sensitive to utility rate escalation. The value of the project depends on the energy consumption, and hence cost of consumption, that the solar offsets. All Scenarios have been modelled using Jacob’s index for utility escalation rate. The Jacobs AEMO Wholesale VIC Low Index is derived from the Jacobs modelling report: *Retail electricity price history and projections prepared for AEMO*¹.

1. https://www.aemo.com.au/-/media/Files/Electricity/NEM/Planning_and_Forecasting/EFI/Jacobs-Retail-electricity-price-history-and-projections_Final-Public-Report-June-2017.pdf

Official Minutes of Knox City Council

FG Advisory

Melbourne

Level 17, 31 Queen Street
Melbourne, Victoria, 3000

Adelaide

Level 30, 91 King William Street
Adelaide, South Australia, 5000

ABN: 69 165 911 571

© 2017 FG Advisory

7. PUBLIC QUESTION TIME

Following the completion of business relating to Item 6, City Development, the business before the Council Meeting was deferred to consider questions submitted by the public.

Question Time commenced at 7.49pm

The following questions were raised with Council:

Question 1	Could Council please provide the gallery with an update on Councils recent and future advocacy for the Rowville Rail?
Answer	Director Bell noted that Councillors Lockwood and Seymour had discussed this item in their Ward Issues. Director Bell advised that the Eastern Transport Coalition is currently working on a broad advocacy plan including the Rowville Rail. A report on Council's Public Transport Advocacy plan is expected to be provided to Council in the next two months outlining the advocacy initiatives for the upcoming 12 months.
Question 2	With the announced reduction in accessible hours for front desk services, could KCC please inform the ratepayers of Knox, how precisely, Full Time workers are expected to view proposals of Planning Applications without impinging on their ability to earn an income? Will KCC be making all planning proposals available online immediately?
Answer	Acting Director Dickie advised that Council staff are currently working towards having these available online in the near future. While there is no exact date for this to be launched in the meantime residents can contact the Planning Department to make individual arrangements to access plans.

7. Public Question Time (cont'd)

Question 3	As a resident of Taylors Lane Rowville for 33 years I and many others are very concerned about inappropriate planning applications and approvals which will have adverse effect on our area in particular the nursing home and proposed 22 dwellings.
Answer	<p>Acting Director Dickie advised that planning applications are subject to a lengthy process including the opportunity for people to object and appeal rights for people not happy with Council's decision.</p> <p>Councillor Pearce added the original application for the nursing home was refused with the applicant dramatically altering their application which was then approved. Had Council rejected the altered application the applicant could have appealed at VCAT and possibly had the larger scale original application approved.</p> <p>The Housing Policy allows for single homes, dual occupancy and some villas where appropriate in this area of Knox. The State Government has determined that nursing homes are allowable in most areas of Knox to cater for an aging population.</p>
Question 4	Would Council please consider naming something or some place after a longstanding officer "engineer" Bob Adam's
Answer	Councillor Mortimore advised he would take the request on board and consider the request in line with Council's policies.

Question Time concluded at 8.05pm

ALL WARDS**8.1 MODULAR (ALTERNATIVE CONSTRUCTION SYSTEMS) BUILDINGS PILOT PROGRAM - PROGRESS REPORT AND TENDER EVALUATION (CONTRACT 2345)**

SUMMARY: *Manager – Community Infrastructure (David Yeouart)*

This reports reviews and completes Stage 2 of the Modular (Alternative Construction Systems) Buildings Pilot Program and recommends a tenderer for the construction of stand-alone Second Change Facilities at Batterham Reserve, The Basin, and Knox Gardens Reserve, Wantirna.

RECOMMENDATION

That Council

1. accepts the tender submitted by Modular Spaces Pty Ltd for the lump sum price of \$986,929.00 excluding GST (\$1,085,622.00 including GST) for Contract No. 2345 – Modular (Alternative Construction Systems) Buildings Pilot Program;
2. approves an \$815,520.00 increase in the budget allocation for the Modular (Alternative Construction Systems) Buildings Pilot Program, noting the increment will be applied to the 2018/19 budget allocation;
3. authorises the Chief Executive Officer to formalise the contract documentation; and
4. advises all tenderers accordingly.

1. INTRODUCTION

Council is experiencing an increased demand for improved and larger community buildings, usually requiring increased community/social space, female change/toilet facilities and improved male facilities.

As a means of facilitating the increase in demand against an ageing building stock, Council resolved to undertake a study into alternative building systems for community and sporting use, including pre-fabricated structures, modular buildings, converted shipping containers and other innovative construction systems.

Following the receipt of an initial report in June 2015, Council initiated Stage 1 of a study into the potential of modular buildings. This resulted in the development of a brief, which was used to engage consultants in a detailed study on Modular (Alternative Construction Systems) Building Structures.

Council received a further briefing in September 2016, documenting the progress made in the development of Modular (Alternative Construction Systems) Building Structures (Stage 1) and seeking input to inform Stage 2 of the study.

8.1 Modular (Alternative Construction Systems) Buildings Pilot Program - Progress Report and Tender Evaluation (Contract 2345) (cont'd)

Further to the September briefing, Council received a report at the Ordinary Meeting on 20 December 2016, on *Female Participation in Structured Sporting Activity and the Capacity and Challenges for Council Infrastructure to Support this Participation*, which concluded:

- There are numerous challenges in providing the infrastructure necessary to meet the expected/projected female participation for Council's sporting facilities.
- Sporting Associations have clear strategies to promote the growth of female participation in sport, however fulfilling these strategies will require significant financial investment from Council, State and Federal Government, state sporting associations and the community.
- Ageing and non-contemporary infrastructure, usage capacity of grounds, and future projected needs all need to be addressed in a holistic manner.
- The Modular (Alternative Construction Systems) Buildings Study for Community and Sporting Use is expected to help bridge the infrastructure gap for sporting facilities, although it is acknowledged that this will not be the only solution to the challenge and will require significant financial investment.
- While Council has a number of policies and programs to assist in the management of this issue, holistic and methodical consideration needs to be given to accommodating the expected increases in participation, including service levels and limitations. This includes the development of a better understanding of the issue and the establishment of a number of options/plans to address. The consistent message however, is that significant investment is required over an extended period of time.

As part of Stage 2 of the Modular (Alternative Construction Systems) Buildings Study, through the 2017/18 budget process, Council approved:

- the delivery of Batterham Reserve, The Basin, stand-alone, second change facility and Knox Gardens Reserve, Wantirna, stand-alone, second change facility, as Pilot Projects in Year 1 in the Capital Works Program;
- a sum of \$550,000 in the 2017/18 Capital Works Program to support the delivery of the two (2) second-change facilities; and
- further design development of the building units (modules) identified in Stage 2 of the study, including detail design, finishes and specification.

8.1 Modular (Alternative Construction Systems) Buildings Pilot Program - Progress Report and Tender Evaluation (Contract 2345) (cont'd)

As a part of Council's forward Capital Works Program, Year 2 of the Pilot Program is planned to include Colchester Park and Lakesfield Reserve, with Year 3 planned to incorporate Seebeck Reserve (subject to Council's annual budget process).

The intent of the Study and Pilot Program is to provide an economic program for the provision of much-needed sporting facilities; to use these initial buildings as a litmus test for developing standard options and to establish indicative prices for other potential additions to Council's sports facilities and other community buildings.

It is of note that other government organisations have embraced the use of prefabricated, modular buildings to solve a number of increasing demands, eg. extra classrooms in public schools.

Since Council has introduced the Study, Sport and Recreation Victoria, Swinburne TAFE and other local authorities have shown interest in the outcomes of the pilot projects and potential involvement.

2. DISCUSSION

2.1 Proposed Works

Following adoption of the 2017/18 Capital Budget and final determination of the facility (nominated club) needs, drawings and specifications were finalised and a number of pre-approved, Victorian Government Construction Supply Registered contractors who have delivered similar facilities, were requested to provide quotations, with expected delivery dates of March 2018.

Unfortunately, Council did not receive any submissions at the required date and following enquires, it was indicated that September 2018 would be the earliest possible date to consider delivery. This is due to the current high demand for their products, particularly from the Victorian Government.

Given the lack of response, the specifications were modified and broadened to enable modular building practitioners (prefabricated, factory built) and traditional builders (fabricated on site) to tender for the works. Through this approach, and on the basis of receiving tender submissions, it was anticipated that Council would have a direct comparison of costs and availability between factory built (prefabricated) and site built facilities (traditional), without losing the core principle of modular building provision.

2.2 Expressions of Interest and Public Tender

No formal Expression of Interest was advertised for this contract.

8.1 Modular (Alternative Construction Systems) Buildings Pilot Program - Progress Report and Tender Evaluation (Contract 2345) (cont'd)

Council advertised a public tender for this project on 27 January 2018 and 3 February 2018, in accordance with Council's Procurement Policy and approved Procurement Plan. The tender closed on 27 February 2018.

2.3 Tenders Received

The following tenders were received:

Tender 1	Ausco Modular Pty Ltd
Tender 2	Modular Spaces Pty Ltd
Tender 3	Atco Structures Pty Ltd
Tender 4	BRB Modular Pty Ltd

While there was considerable interest in the specifications, in an unexpected turn, Council only received submissions from modular building practitioners, (ie. no traditional builders submitted a tender).

Although there is no direct cost comparison between traditional and pre-fabricators for the two pilot projects, the modified specification increased the potential market for provision of these buildings in a time where the building industry is experiencing high demand.

The prices received however are estimated to be less than a traditional type build, which would be expected to be in the order of \$750,000 for each site. This does not include site services, site works, project management, etc.

2.3.2 Evaluation Panel

The Tender Evaluation Panel consisted of suitably qualified panel members experienced in the evaluation and award of works projects.

All members of the Panel signed the Tender Evaluation Panel Declaration Form indicating that they had no conflict of interest or association with any of the submitting tenderers.

2.3.3 Evaluation Criteria

The evaluation criteria, as listed in the Conditions of Tender, have been assigned the following weightings as documented in the Procurement Plan:

Price	40%
Proposed Methodology/Solution and Works Program	30%
Evidence of Capability, Demonstrated Experience and Expertise	20%
Business Capacity	10%
TOTAL	100%

8.1 Modular (Alternative Construction Systems) Buildings Pilot Program - Progress Report and Tender Evaluation (Contract 2345) (cont'd)

The tender also nominated the following mandatory criteria:

- Quality Management - Systems & Process.
- Occupational Health and Safety Systems - and Process.
- Signing of Schedule 4 – Statutory Declaration of Non-Collusive Tender.
- Insurances - \$20M Public Liability and WorkCover.

2.4 Tender Evaluation Results

After considering the tender submissions, the Evaluation Panel arrived at the following summary results:

Ranking Order	Tenderer
1	Modular Spaces Pty Ltd
2	Atco Structurers Pty Ltd
3	BRB Modular Pty Ltd
4	Ausco Modular Pty Ltd

The final evaluation matrix is included with the Confidential Procurement Report appended to this report.

2.4.1 Preferred Tenderer

Modular Spaces Pty Ltd is the recommended tenderer with the highest evaluation score. The following is noted in regard to Modular Spaces Pty Ltd.

- Modular spaces Pty Ltd has undertaken several commercial and residential projects of similar nature, which have been completed 95% in factory and transported to site for assembly and final fit off.
- The rates submitted for these works are competitive and reflect the current market for this type of project.

It is anticipated that Modular Spaces Pty Ltd will give satisfactory performance and successfully deliver the works.

2.4.2 Second Preferred Tender

Atco Building Structures is the second preferred contractor with the second highest evaluation score. The following is noted in regard to Atco Structures Pty Ltd.

- Their rates are also regarded as competitive and reasonable given the market conditions for this type of work and they have shown an appreciation of the scope of works required under the contract.

8.1 Modular (Alternative Construction Systems) Buildings Pilot Program - Progress Report and Tender Evaluation (Contract 2345) (cont'd)

- Atco Structures Pty Ltd is one of the largest suppliers of modular buildings and it is also anticipated that they would give satisfactory performance and successfully deliver the project.

3. CONSULTATION

As part of the design development process, the needs of each nominated club were refined with their input provided. The architectural consultant, engaged to partner Council in the project, was commissioned to undertake industry research.

There is a high level of expectation from all clubs that have been involved in the pilot program. In the case of the 2017/18 Pilot Projects, there was an expectation that the changing facilities would be delivered to coincide with the commencement of the 2018 football season. Both of the affected clubs have been actively recruiting female teams for both juniors and seniors.

Council has since informed the two (2) clubs that the facilities have been delayed. Council may wish to assist the clubs by providing temporary, portable change rooms to support the additional female teams (junior and senior) that will be fielded by The Basin Football Club and Knox Football Club during the 2018 season.

To support the process, including the raising of awareness of both the Council and of officers, it is noted that both members of Council and staff from Council's Engineering and Infrastructure directorate have attended forums and conferences on the use of modular construction systems over the past 18 months.

4. ENVIRONMENTAL/AMENITY ISSUES

The new, stand-alone facilities will minimise costs for additional service infrastructure and connections and reduce the impact on existing surrounding infrastructure, eg. carparks, lighting, playgrounds, etc.

The focus of the Modular (Alternative Construction Systems) Buildings project is to improve amenity for the service users, at a reasonable cost, with an aim to increasing the number of facilities in response to community demand.

No environmental or amenity issues needed to be further considered in the evaluation of tenders.

8.1 Modular (Alternative Construction Systems) Buildings Pilot Program - Progress Report and Tender Evaluation (Contract 2345) (cont'd)

5. FINANCIAL & ECONOMIC IMPLICATIONS

5.1 Projected Costs

The projected project cost and funding is summarised below:

Description	Cost (excluding GST)
Adjusted Contract Lump Sum Price	\$986,930.00
Plumbing (sewer, water and ancillaries)	\$58,578.00
Electrical (cabling, supply upgrade and ancillaries)	\$70,761.00
Permits	\$16,000.00
Civil Works-DDA compliant carpark	\$50,000.00
	\$1,182,269.00
Project Management (5% of project cost)	\$59,113.00
Contingencies (10% of project cost)	\$124,138.00
Total Project Cost:	\$1,365,520.00

5.2 Funds Available

Stage 2 of the Study indicated a build cost of \$550,000 for the provision of the two (2) second change facilities, which was adopted in the 2017/18 Capital Budget (Year 1 of the Modular (Alternative Construction Systems) Building Program).

Year 2 on the Modular (Alternative Construction Systems) Building Program has a provisional \$720,000 for the construction of facilities at Colchester Park and Lysterfield Reserve.

The briefings to Council reflected that this was a Pilot Project with indicative costs and that actual costs inclusive of site works and site services (ie. water, electricity, sewer) would need to be considered as the Pilot progressed.

The further development of the Pilot Program and subsequent design and consultation resulted in an increased size and function of both buildings.

As a consequence of the high levels of activity in the construction market (reflected in the lack of initial industry response), and the required cost of site services, a higher than initially anticipated cost has emanated.

However, it is considered that this price is more aligned with the true and future costs and will inform any future roll-out of the Pilot Program. For example, a modular, lawn tennis pavilion was recently constructed in Sunbury at a cost of \$650,000 with a 16 week construction period (10 weeks off-site and 6 weeks on-site). Whilst marginally a larger footprint than that proposed for both Batterham Reserve and Knox Gardens, the cost is deemed comparable to the tenders received.

8.1 Modular (Alternative Construction Systems) Buildings Pilot Program - Progress Report and Tender Evaluation (Contract 2345) (cont'd)

As Council has now been to public tender for these facilities, actual construction costs are presented in this report.

An integral element of this project is to recognise these are the Pilot sites and that a review process should be undertaken with stakeholders involved, upon completion, to inform future potential business cases.

The total project cost shows a shortfall of \$815,520.00 which incorporates the contract sum of the preferred tenderer and the costs associated with site services, site works, etc.

Given the lack of initial response, the project would now expected to be completed in October 2018 and any increase in budget allocation could be applied to the 2018/19 Capital Budget.

6. SOCIAL IMPLICATIONS

Community buildings perform a number of important functions and in the case of sporting pavilions, this extends to providing a focus for the local community beyond the sport.

A number of these pavilions perform the function of community gathering spaces or hubs for a range of different activities.

Providing new and upgraded infrastructure, which accommodates the anticipated growth in female participation, would deliver a number of social benefits to the community, including:

- improved access to quality sport and recreation opportunities;
- improved physical and mental wellbeing outcomes;
- culture of improved gender equity;
- greater connectivity for individuals to engage within community based projects;
- maximisation of community and Council facilities; and
- increased capacity for local organisations to deliver activities and community programs.

No social implications needed to be further considered in the evaluation of tenders.

8.1 Modular (Alternative Construction Systems) Buildings Pilot Program - Progress Report and Tender Evaluation (Contract 2345) (cont'd)

7. RELEVANCE TO KNOX COMMUNITY AND COUNCIL PLAN 2017-2021

Goal 1. We value our natural and built environment.

Strategy 1.3 Ensure that Knox local character is protected and enhanced through the design and location of urban development and infrastructure.

Council role and focus: Partner with a range of community organisations and other levels of government to plan and deliver community facilities (including multi-use hubs) and infrastructure.

Goal 6. We are healthy, happy and well.

Strategy 6.2 Support the community to enable positive physical and mental health.

Action 6.2.3 Progressively upgrade Council's sporting facilities in line with universal design to support an increase in female participation in sport.

Council role and focus: Partner with sporting clubs and community groups to identify initiatives to engage women and girls to increase their participation in community sports and activities. Provide services and community infrastructure which supports sporting, recreational, cultural and leisure activities and encourage greater participation.

Goal 7. We are inclusive, feel a sense of belonging and value our identity.

Strategy 7.3 Strengthen community connections.

Council role and focus: Plan infrastructure, open space and community facilities to increase community connectedness. Provide a range of services and infrastructure that positively contribute to people's sense of belonging.

8. CONFLICT OF INTEREST

Under section 80c of the Local Government Act 1989 officers providing advice to Council must disclose any interests, including the type of interest.

Officer Responsible – (Ian Bell, Director Engineering and Infrastructure) - In providing this advice as the Officer Responsible, I have no disclosable interests in this report.

Author – (David Yeouart, Manager Community Infrastructure) - In providing this advice as the Author, I have no disclosable interests in this report

8.1 Modular (Alternative Construction Systems) Buildings Pilot Program - Progress Report and Tender Evaluation (Contract 2345) (cont'd)

9. CONCLUSION

The construction market is currently experiencing high demand which has resulted in procurement delays and a subsequent increase in cost to provide the pilot buildings. It is noted that the current heat in the market is impacting on the prices received across all project delivery organisation and agencies – not just Knox.

The increased interest and demand in modular type buildings as a cost effective and efficient building delivery system is expected to continue and the prices received are reflective of the market, at this time.

The public tender has now informed Council of the actual market cost of supply and is believed to be a viable alternative to traditional build techniques.

The tender representing best value for money was presented by Modular Spaces Pty Ltd for the lump sum price of \$986,930 (\$1,085,622 including GST). The company is adequately resourced and available to successfully undertake this contract within the constraints of time, quality and cost as detailed in the contract documentation.

In times of high demand and consequently, scarce resources, the use of traditional and pre-fabricated provision of sporting facilities increases the breadth of those able to tender for works and should produce more competitive prices.

The concept of modular buildings enables more equitable service levels, reduces time (cost) in developing layouts and negates bespoke design.

Council is asked to consider additional funding in the 2018/19 Capital Works Program to deliver these pilot projects.

10. CONFIDENTIALITY

The Procurement Report, including the tendered prices, evaluation matrix and completed Panel Evaluation Form is provided separately to this report.

There are no confidentiality issues with this report.

8.1 Modular (Alternative Construction Systems) Buildings Pilot Program - Progress Report and Tender Evaluation (Contract 2345) (cont'd)**COUNCIL RESOLUTION****MOVED: CR. LOCKWOOD****SECONDED: CR. PEARCE**

That Council:

1. accepts the tender submitted by Modular Spaces Pty Ltd for the lump sum price of \$986,929.00 excluding GST (\$1,085,622.00 including GST) for Contract No. 2345 – Modular (Modern Construction Systems) Buildings Pilot Program;
2. approves an \$815,520.00 increase in the budget allocation for the Modular (Modern Construction Systems) Buildings Pilot Program, noting the increment will be applied to the 2018/19 budget allocation;
3. authorises the Chief Executive Officer to formalise the contract documentation;
4. advises all tenderers accordingly; and
5. continues to work with the modular building industry in the development of community and sporting building systems and:
 - 5.1 following the commission of the Year 1 - Pilot Program change facilities, Council receives a review of the project which will include a status of the wider, modular building industry, reflections of processes to date and future trends; and
 - 5.2 as a part of the delivery of the Pilot Program, ensure that a collaborative approach is adopted with all stakeholders, in order to inform the review and create a learning experience for potential future projects.

CARRIED

ALL WARDS**9.1 DRAFT KNOX CIVIC ART COLLECTION MANAGEMENT POLICY**

SUMMARY: *Manager - Youth, Leisure, Cultural Services (Peter Gore)*

This report provides Council with a draft of the Knox Civic Art Collection Management Policy. The draft policy has been endorsed by the Knox Arts and Culture Advisory Committee and was prepared based on industry best practice.

RECOMMENDATION

That Council:

Approve the Knox Civic Art Collection Management Policy as provided in Appendix 1.

1. INTRODUCTION

The Knox Civic Art Collection refers to indoor artworks that are collected by Council to build a cultural and financial asset, and to enhance the civic spaces within Knox.

Best practice industry standards recommend the use of a Civic Art Collection Management Policy to provide a clear framework for the acquisition, management and de-accession of indoor artworks owned by Local Governments.

Council has not had a policy framework to guide the acquisition and management of the art collection to date, and the draft policy will provide Council with a formal process to select, acquire and manage artworks for the collection.

Research into industry standards relating to small art collections, particularly art collections belonging to Australian local governments has informed the policy framework and objectives.

The Draft Knox Civic Art Collection Management Policy ('the Policy') has been developed with the following objectives:

- Outline and implement the process for acquiring artworks for the Knox Civic Art Collection ('the collection') through purchase; commission; donation or bequest;
- Provide selection criteria to guide the acquisition of new artworks for the collection;
- Provide clarity on previous donations and bequests to the collection;
- Provide guidelines for the appropriate and innovative display of the collection;

9.1 Draft Knox Civic Art Collection Management Policy (cont'd)

- Outline and implement the process for the deaccession and disposal of artworks from the collection;
- Provide guidelines as to the maintenance, storage, and insurance requirements of the collection.

2. DISCUSSION

2.1 Policy Context

The Knox Arts and Cultural Plan 2017-2021 outlines Council's commitment to developing a Knox Civic Art Collection Management Policy.

The Knox Civic Art Collection Management Policy sits in the following strategic context of Council Plans and Policies:



A Civic Art Collection is an important part of Council activity as it:

- assists in building community identity;
- enhances the civic spaces and integrity of public buildings;
- makes the arts more accessible to the wider community;
- reflects the culture and interests of the community and Council;
- provides an educative function about the value of the arts in our community;
- supports arts development and creative industry growth;
- enhances opportunities for cultural tourism;
- can be a valuable resource for local schools and tertiary institutions; and
- enables Council to enhance and grow the arts and cultural asset of the community.

9.1 Draft Knox Civic Art Collection Management Policy (cont'd)

Council's draft Knox Civic Art Collection Management Policy contains a number of standard and key acquisition criteria that provide a clear method of assessing the eligibility of artworks for accession into the Knox Civic Art Collection.

Art acquisitions may be recommended by Councillors, senior officers or the general public.

The policy acknowledges that Council has limited artwork display space, with no current public gallery or museum asset. It also reflects the limitations presented by the lack of gallery nor museum standard storage for two-dimensional work, presenting a need to limit the number of items collected annually, and the likelihood of deaccession of those pieces that do not fit well within the policy context.

The approval of civic art acquisitions will initially be assessed by the Community and Public Arts Officer, and will be approved by the Coordinator Arts and Cultural Services, the Manager Leisure, Youth and Cultural Services, and the Director, Community Services, who may consult the Executive Management Team and Council as required.

The same approval process will be undertaken for items within the collection that are nominated by the Community and Public Art Officer for de-accession.

De-accession of an item within the collection will be nominated where the item no longer meets the standard requirements and selection criteria for the collection, as outlined within the policy.

The civic artwork will be regularly displayed within civic offices, and may also include other Council facilities depending upon site suitability.

The collection will be listed within Council's asset register, and recorded within a civic art collection catalogue.

The collection will be stored in a dry and secure venue, presently located at Millers Homestead. Council will endeavour to seek museum industry standard storage (temperature controlled, secure environment) to house the collection in future years.

The process of deaccession involves the removal, sale, relocation or disposal of an existing artwork by Council. Following an audit of the collection scheduled for late 2018, artwork identified for deaccession will be removed from the collection according to the deaccession criteria contained within the policy.

2.2 Knox Arts & Cultural Plan 2012-22

An objective of Council's adopted Arts & Cultural Plan 2012-22 is "Creating Vibrant Public Places" through the stated goal: To enable and promote the inclusion of a wide range of creative initiatives to be developed and performed or installed in the public realm, for the enjoyment of the community and to support the creation of healthy strong communities.

9.1 Draft Knox Civic Art Collection Management Policy (cont'd)

To deliver on this objective and goals of the *Arts & Cultural Plan 2012-22* the following activity is recommended:

1.6 Include a review of the Council's current acquisition and maintenance process to include the civic art collection, in order to better manage this Council asset.

2.3 Knox Civic Art Collection Management Policy

The draft Knox Civic Art Collection Management Policy was prepared following considerable research and benchmarking other Councils. The draft policy outlines the objectives of the collection and the processes for its management.

2.4 Relevant Documents

The following Council documents are relevant to the draft Knox Civic Art Collection Management Policy:

- Community and Council Plan 2017 – 2022.
- Arts and Culture Service Plan 2017 – 2021.
- Public Art Policy 2018 – 2022.
- Public Art Implementation Plan 2018 – 2022.
- Asset Management Policy 2013.

3. CONSULTATION

The draft Knox Civic Art Collection Management Policy has been written internally by relevant Council officers based on extensive research of industry trends and best practice. The draft Knox Civic Art Collection Management Policy was then presented to and endorsed by the Knox Arts and Culture Advisory Committee on 21 February 2018.

4. ENVIRONMENTAL/AMENITY ISSUES

The draft Knox Civic Art Collection Management Policy provides the framework for the development and management of the Knox Civic Art Collection. It aims to contribute to the development of a program for increasing the liveability of the city, through its built and natural spaces.

5. FINANCIAL & ECONOMIC IMPLICATIONS

Council funding for the acquisition of art for the Knox Civic Art Collection is included within the Community and Public Arts budget as outlined in the policy, Maintenance of the Knox Civic Art Collection is generally funded through an artwork renewal budget.

9.1 Draft Knox Civic Art Collection Management Policy (cont'd)

6. SOCIAL IMPLICATIONS

As outlined earlier in section 3, a Civic Art Collection can contribute much to the local community. As well as being an asset, the collection can serve as a valuable educational and engagement tool.

7. RELEVANCE TO KNOX COMMUNITY AND COUNCIL PLAN 2017-2021

7.1 Knox Community and Council Plan 2017 – 2021

The draft Knox Civic Art Collection Management Policy will contribute to the following Community and Council Plan (2017 – 2021) items:

Goal 1: We value our natural built environment.

Goal 5: We have strong regional economy, local employment and learning opportunities.

Goal 7: We are inclusive, feel a sense of belonging and value our identity.

8. CONFLICT OF INTEREST

Under section 80c of the Local Government Act 1989 officers providing advice to Council must disclose any interests, including the type of interest.

Officer Responsible – Peter Gore, Manager Youth, Leisure and Cultural Arts - In providing this advice as the Officer Responsible, I have no disclosable interests in this report.

Author – Elissa Pachacz, Coordinator Arts & Cultural Services - In providing this advice as the Author, I have no disclosable interests in this report.

9. CONCLUSION

The draft Knox Civic Art Collection Management Policy will provide Council with a framework for the management of the Knox Civic Art Collection. The document ensures a commitment by Council to developing and managing the collection for the period of the Policy (2018-2022). In line with industry best practice, processes for the acquisition, administration, maintenance, display, insurance, storage and deaccessioning of artworks are clearly articulated to provide for a well-considered and managed Council asset.

10. CONFIDENTIALITY

There are no issues of confidentiality associated with the content of this report.

9.1 Draft Knox Civic Art Collection Management Policy (cont'd)

COUNCIL RESOLUTION

MOVED: CR. LOCKWOOD

SECONDED: CR. PEARCE

That Council approve the Knox Civic Art Collection Management Policy as provided in Appendix 1 with the following amendments (highlighted in italics):

- 7.2 Aims of the Knox Civic Art Collection:

The overall collection will fulfil the majority of the following aims:

- Reflect the artistic, cultural and social development of the City of Knox;
- Contain works of artistic excellence, quality and skill;
- Provide the community with opportunities to engage with artworks;
- Recognise artists who live, work, exhibit or contribute to the creative culture of Knox;
- Enhance Knox community's awareness, understanding and appreciation of art;
- Enhance civic spaces through the exhibition of art;
- Generate discussion and debate about art, culture, social and environmental issues; and
- Over time, build the cultural, historical and economic value of the Collection as an asset of the City of Knox.

- 7.4.1 — Standard Requirements (Dot Point 9)

- *Will be collected ethically.* Delete the statement: "external influences will not be tolerated."

- 7.4.2 – Key Acquisition Selection Criteria

Delete the words: "The artwork must be".

- 7.5 – Donations (Replace section to read)

Knox City Council is not registered as a Deductible gift recipient organisation and therefore, donors do not receive any taxation incentive.

Artwork submitted to Council will be considered having regard to the aims of the Civic Art Collection.

**9.1 Draft Knox Civic Art Collection Management Policy (cont'd)
Resolution (cont'd)**

- **7.14.1 – De-accession Selection**

Change the following words 'who may refer the de-accession approval to the Executive Management Team our Council as deemed necessary,' to
Who will refer the de-accession recommendation to Council for consideration

CARRIED

SUBSEQUENT MOTION

MOVED: CR. GILL
SECONDED: CR. TAYLOR

That Council maintain the Mayoral Portraits in their current location for the foreseeable future

LOST

Official Minutes of Knox City Council

Draft Knox Civic Art Collection Management Policy

Policy Number:		Directorate:	Community Services
Approval by:	Council	Responsible Officer:	Manager Youth Leisure & Cultural Services
Approval Date:	27 March 2018	Version Number:	1
Review Date:	27 March 2022		

1. Purpose

To provide a policy framework for the acquisition or commission display and management of two and three dimensional works artworks that will become a component of the permanent Civic Art Collection for Knox City Council, known as the Knox Civic Art Collection ('the collection'). This does not include Public Artworks, the Knox Civic Memorabilia Collection or City entrance signs and memorials, which have separate policy frameworks.

2. Context

The Knox Civic Art Collection has been acquired by commission, purchase, donation or bequest over many years, and is continually growing. The collection requires a clear purpose allowing for the collection to represent a more clearly articulated focus and within agreed selection frameworks and approval guidelines.

The Knox Art Collection Management Policy ('the policy') sits alongside the Knox Public Art Action Plan and Public Art Policy, which guide the management of the Art in Public Spaces collection, which relates to artworks in the public realm (usually located within an outdoor civic space).

The policy is based on research into industry standards relating to small art collections, particularly art collections belonging to Australian local governments.

The policy acknowledges that Council has limited display space, with no current public gallery or museum asset. It also reflects the limitations presented by the lack of gallery nor museum standard storage for two-dimensional work, presenting a need to limit the number of items collected annually, and the likelihood of deaccession of those pieces that do not fit well within the policy context.

3. Scope

The Knox Civic Art Collection Policy will apply to all Councillors, Council officers and any other person invited by Council to advise on matters relating to the indoor civic art collection, including the:

- Acquisition (purchase or commission) or loaning of civic artworks;
- The assessment and approval process for acquiring, managing and de-accessing civic artworks;

- Accession, cataloguing and storage of civic artworks;
- Maintenance and display of civic artworks;
- Financial and resource management of civic artwork;
- De-accession of civic artworks; and
- Policy and strategic context of the Knox Civic Art Collection.

4. Objectives

The aims of the Knox Art Collection Acquisition Policy are to:

- Outline and implement the process for acquiring artworks for the Knox Civic Art Collection ('the collection') through purchase; commission; donation or bequest;
- Provide standard and key selection criteria to guide the acquisition of new artworks for the collection;
- Provide clarity on the management of previous donations and bequests to the collection
- Provide guidelines for the appropriate and innovative display of the collection;
- Outline and implement the process for the deaccession and disposal of artworks from the collection;
- Provide guidelines as to the maintenance, storage, and insurance requirements of the collection.

5. References

5.1 Community & Council Plan 2017-2021

Goal 1: We value our natural built environment.

Goal 5: We have strong regional economy, local employment and learning opportunities.

Goal 7: We are inclusive, feel a sense of belonging and value our identity.

5.2 Relevant Legislation

- Local Government Act 1989 – Conflict and Interest Provisions

5.3 Charter of Human Rights

- This policy has been assessed against and complies with the Charter of Human Rights.

5.4 Related Council Policies

- Knox Arts & Cultural Plan 2012-2022
- Public Art Policy 2017-2022
- Public Art Action Plan 2018-2022
- Election Period Policy
- Councillor Code of Conduct

5.5 Related Council Procedures

- Nil

6. Definitions

Acquisition	An asset or object bought or obtained by Council for the Civic Art Collection.
Accession	The process of creating a permanent record of an acquired asset or object, whereby Council undertakes the assemblage, custody, right, title, and assignment of a unique control number to said object for inclusion in the Civic Art Collection, also referred to as cataloguing.
Art in Public Spaces Collection	This collection consists of public and community art acquisitions, including artwork made by the Placemaker team over twenty years and more recent community art projects made with the community, as well as public artworks (usually outdoor / in the public realm). Council's Public Art Policy and Public Art Action Plan guide the management of this collection.
Art Platforms	Means permanent infrastructure elements designed as a site for temporary art installations. They may be located in parks, plazas, streets or the entry to a civic building. Platforms may include curated 'billboards', 'light boxes', or digital screens that can be used for new media art as well as for event programming and special broadcasts.
Bequests	Is a form of acquisition by way of Council receiving artworks from a deceased estate via a will.
Commission	Is a form of acquisition by way of Council purchasing an artwork that is the result of a new work being created for a specific site or purpose.
Conflicts of interest	A conflict of interest is a situation in which someone in a position of trust or authority finds themselves with competing professional and personal interests. Such competing interests may make it difficult for the individual to be objective or impartial. If they were not to declare their potential conflict of interest, or remove themselves from this situation, it may be interpreted as an act of impropriety or unethical behaviour.
Contemporary art practice	Contemporary art practice refers to recent artworks across a range of media and styles. It usually refers to new works engaging with current artistic, cultural and social developments and trends. Contemporary visual artworks often utilize the materials and techniques of their time.
Council Initiated Art Project or Program	A Council initiated art project or program refers to an art project or program designed and implemented by Council, responding to a perceived community need.
Donations	Is a form of acquisition by way of Council receiving artwork by gift.
Deaccession	Means the removal, sale, relocation or disposal of an existing artwork owned by Council.

Deductible gift recipient	<p>A deductible gift recipient (DGR) is an entity or fund that can receive tax deductible gifts. There are two types of DGR endorsement:</p> <ul style="list-style-type: none"> • An entity that has DGR endorsement in its own right; • An entity that is only a DGR in relation to a fund, authority or institution it operates. In this instance, only gifts to the fund, authority or institution are tax deductible. Knox City Council does not have DGR endorsement status.
Exhibition	This refers to the public display of objects or artworks.
Knox Civic Ephemera and Memorabilia Collection	This civic collection includes commemorative plaques, Mayoral attire, (including but not limited to robes and chains), printed photos of Council project and programs, Councillor photos and Mayoral photos, Certificates and Awards.
Provenance	As it relates to artwork, provenance means the history of ownership of an object. It is important to know the history of the object when acquiring art to ensure that it is not stolen and that it has been created and offered for sale, donation or bequest in an ethically sound manner.

7. Council Policy

7.1 Overview

Art Collection Management involves caring for and administering works of art, guided by policy and procedures that help define the purpose, quality and focus of the collection. These activities can include organisational policies, buildings, security, storage, cleaning, preservation, maintenance, handling, environmental monitoring and control, exhibitions and loans, conservation, emergency preparedness and response planning.

Acquisition is the process by which Council legally and formally accepts objects as part of its civic art collection. It refers artworks that are purchased by Council, commissioned by Council, donated or bequeathed to Council.

7.2 Aims of the Knox Civic Art Collection

All works will aim towards the development of a unique collection. The collection itself will aim to fulfil the following criteria:

- Reflect the artistic, cultural and social development of the City of Knox;
- Contain works of artistic excellence, quality and skill;
- Provide the community with opportunities to engage with artworks;
- Recognise artists who live, work, exhibit or contribute to the creative culture of Knox;
- Enhance Knox community's awareness, understanding and appreciation of art;
- Enhance civic spaces through the exhibition of art;
- Generate discussion and debate about art, culture, social and environmental issues; and

- Over time, build the cultural, historical and economic value of the Collection as an asset of the City of Knox.

7.3 Art Collection Acquisitions

Acquisitions for the collection are made by Council purchasing or commissioning artworks. Civic Art can be acquired or commissions through recommendation by Councillors, Senior Officers or members of the general public.

Artworks may be purchased from reputable galleries or directly from the artist (if not represented by a gallery), by commission, or via Council initiated art projects and programs.

Items purchased for the Knox Civic Art Collection are procured through the Knox Civic Art Collection Budget, which is reviewed annually.

7.4 Acquisition Selection Criteria

To be eligible for acquisition into the Knox Civic Art Collection, artworks must:

- Contribute to achieving the aims of the Civic Art Collection Policy (Item 7.2);
- Meet all of the 'Standard Requirements' (item 7.4.1);
- Meet one or more of the 'Key Selection Criteria' relevant to the collection category to which it belongs (Item 7.4.2).

7.4.1 Standard Requirements

In order for an artwork to be considered for the Knox Civic Art Collection, the item must meet the following standards:

- In good condition.
- A durable artwork that is appropriate for the situation it is intended to be displayed in (unless it is intended to be an ephemeral artwork).
- A soundly conserved piece of art.
- An unconditional purchase which has valid and clearly verifiable legal title.
- A clearly established and verifiable provenance.
- Able to have the capacity to be placed on display in Council buildings or in public spaces without hindering public access or safety.
- Able to have capacity to be placed on display without breaching the artist's moral rights.
- Accompanied by a Certificate of Authentication from the Vendor/Gallery where the work was purchased or an equivalent signed document from the artist.
- Collected ethically; external influences will not be tolerated.
- Purchased in an accountable and transparent matter.

When considering an artwork for acquisition, officers must also consider the necessary resources required to resolve all foreseeable issues relating to the conservation, framing, presentation and storage of the work and factor this into forward budget planning where required.

7.4.2 Key Acquisition Selection Criteria

An item of art is eligible for acquisition if it is a quality example of what is considered to be contemporary art practice and it meets one or more of the following criteria.

The artwork must be:

- Of high artistic quality
- Able to show a distinctive and verifiable connection with the City of Knox, such as being a work of art by an artist who has lived, worked, exhibited or contributed to the creative culture of Knox
- A work of art that relates to the ongoing ethics and cultural policies of Knox Council.
- A work that engages with important social, cultural and environmental issues in a considered and creative manner
- An innovative artwork that reflects current trends within a broader context of contemporary Australian art
- A work that enhances the status and diversity of the Knox Art Collection

7.5 Donations

Knox City Council is not registered as a donor gift recipient organisation and is therefore unable to accept donations into the collection from this point. All donations previously accepted by Council into the collection should be considered for deaccession.

7.6 Loans

- Loan requests from external institutions will be reviewed by the Community and Public Art Officer;
- Requests will only be considered from an accredited institution, professional Gallery, and/or museum. The borrower must demonstrate it maintains appropriate standards for the receipt, care and display of the object requested for loan.
- A loan contract and condition report shall be issued with all approved loans.
- The borrowing institution shall accept all responsibility for wall-to-wall insurance, crates, shipping, and repair costs associated with the loan unless otherwise specified in the loan contract.

7.7 Acquisition Approval Process

Acquisitions for the Knox Civic Art Collection will be initially assessed by the Community and Public Art officer alongside the acquisition selection criteria (Item 7.4), and will include an image, artwork details and be accompanied by short rationale statement, information about the artist and exhibition reviews where available, as well as maintenance considerations pertaining to the artwork. Recommendations for acquisition will then be presented for approval to:

- Coordinator, Arts and Cultural Services;
- Manager, Leisure, Youth and Cultural Services
- Director Community Services, who may refer the acquisition approval to the Executive Management Team or Council as deemed necessary.

For works in specialised fields of art, the Community and Public Art Officer may invite recommendations from specialists with acknowledged expertise in the area when deemed beneficial.

Conflicts of interest must be declared prior to approving artwork for the collection.

7.8 Access to the Knox Civic Art Collection

The Knox Civic Art Collection aims to be accessible to the Knox community and to enhance awareness, understanding and appreciation of art. The collection will be made accessible to the community by being displayed:

- Within indoor public spaces in Council buildings, with priority being given to areas that the Knox community have access to such as foyer areas, meeting rooms and libraries
- Where possible, via Knox public art platforms, such as the Gilbert Skate Park Billboard and Cinema Lane Light boxes (Boronia).

It should be noted that not all artworks in the Collection are appropriate for long-term display in public areas due to their fragility or the high risk of theft and damage.

7.9 Accession Administration

When an artwork enters the Knox City Council collection, it will be undergo an accession process, whereby it will be entered in the collection database and all information registered into the Knox City Council Electronic Data Management System. Information that should be included in the file includes:

- Artist resume, statements, articles if available
- Instructions for care and maintenance
- Purchase forms
- Provenance of the artwork that details the ownership & history of the work since its creation
- Any appraisal as to the value of the work
- Any instruction for the assembly or installation

7.10 Maintenance

The Collection will be audited and condition reported every 4 years or in accordance with Council's asset audit policy. This process will identify specific artworks that need maintenance or repair, and a suggested plan for this to be undertaken.

The costs associated with maintaining the collection will be covered through the artwork renewal budget and reviewed annually.

7.11 Display

The collection will be displayed within Council owned Civic Offices, and may extend to other locations such as Libraries, Recreation Facilities and Community Centres. Each selected location will be assessed in terms of its public access/visibility, artwork suitability, security and maintenance of the artwork/s.

7.12 Insurance

All works in the collection are covered under Knox City Council's insurance policy, to the value at the time of acquisition, with options for revalue as required as part of the annual insurance policy. Artworks on loan

for exhibition will be registered with Knox City Council's Insurance Officer, and reviewed alongside the Insurance Policy requirements.

7.13 Storage

Works are currently stored in the collection storeroom at Millers Homestead, Millers Road, Boronia. Custom made cupboards house the collection. Further temperature-controlled storage will be required in the near future.

7.14 De-accessioning of Collection Items

De-accessioning (removal, sale, relocation or disposal) of artworks in the collection may be required from time to time. The process for de-accession is as follows:

7.14.1 De-accession Selection

The Community and Public Arts Officer may nominate a registered Knox Civic Art Collection item for de-accession. Using the criteria outlined in Item 7.14.3, the Community and Public Arts Officer will report on the de-accession recommendation to the Coordinator, Arts and Cultural Services; the Manager, Leisure, Youth and Cultural Services and the Director of Community Services, who may refer the de-accession approval to the Executive Management Team or Council as deemed necessary.

The report will include a clear recommendation and rationale as to the method of de-accession (removal, sale, relocation or disposal).

7.14.2 Sale of Items from the collection.

As indicated by best practice, where an item is approved for de-accession and sale, income from art sales will be retained as a resource to acquire, maintain or manage the Civic Art Collection, rather than consolidated revenue to Council.

7.14.3 De-accession Criteria

An item may be nominated by the Community and Public Art Officer for de-accessioning if it adheres to any of the following categories:

The artwork:

- No longer contributes to the aims of the Civic Art Collection (Item 7.1), no longer meets the standard collection requirements (Item 7.4.1) or key selection criteria (7.4.2).
- Is in poor condition and is considered to be of insufficient merit to allocate the resources to ensure its conservation;
- Cannot be displayed due to its properties, and is not suitable for research;
- Is an item that cannot be effectively stored, maintained or installed within current resources;
- Is a duplicate or forgery that serves no specific cultural function;
- Is irreparably damaged or destroyed;

- Is missing or stolen without hope of return; or
- Has been donated and does not meet acquisition standard requirements or selection criteria.

7.14.4 Methods for Disposal

All effort will be made to contact the artist. Providing contact details are available, artists will be notified if their work is being considered for de-accession. This disposal procedure for an item identified to be de-accessioned will adhere to the following order of options. The option for disposal in order of priority is that the item:

- May be offered for sale or donation as appropriate, to its creator or the donor
- May be offered to a more appropriate collecting agency or institution
- May be resold on the public market, or
- May be dismantled and / or destroyed in the event of no other options being suitable.

Knox Councillors and Knox Council Officers and their families are prohibited from obtaining an item de-accessioned from the Collection as this can be interpreted as a conflict of interest. A record of all items de-accessioned, and their method of disposal must be kept.

8. Administrative Updates

From time to time, circumstances may change leading to the need for minor administrative changes to this policy. Where an update does not materially alter this policy, such a change may be made administratively. Examples of minor administrative changes include changes to names of Council departments or positions, change to names of Federal or State Government departments or a minor amendment to legislation that does not have material impact. Where any change or update may materially change the intent of this policy, it must be considered by Council.

ALL WARDS

9.2 KNOX MULTICULTURAL ADVISORY COMMITTEE ACHIEVEMENTS 2012-2017 AND KNOX MULTICULTURAL STRATEGIC PLAN 2012-2017 IMPLEMENTATION OUTCOMES

SUMMARY: *Joan Pepi, Multicultural Communities Officer*

The Knox Multicultural Strategic Plan 2012-2017 was adopted by Council in 2012 and its implementation has been monitored with the assistance of the Knox Multicultural Advisory Committee.

This report outlines the activities and achievements of Knox Multicultural Advisory Committee from 2012-2017 and outcomes of the implementation of the Knox Multicultural Strategic Plan since 2012.

RECOMMENDATION

That Council

1. Notes the achievements of the Knox Multicultural Advisory Committee for the 2012-2017 period as shown at Appendix A; and
2. Notes the outcomes, achievements and challenges of the delivery of the Knox Multicultural Strategic Plan 2012 - 2017 (the Plan) and the actions for that period as shown in Appendix B.

1. INTRODUCTION

The Knox Multicultural Advisory Committee (KMAC) was established in March 2009 to provide Council with advice on multicultural issues and promote greater awareness and understanding in the local community of cultural diversity in Knox.

The *Knox Multicultural Strategic Plan 2012-2017* (the Plan) was developed following feedback from KMAC that research and broad community engagement be undertaken to enable them to increase their capacity to provide advice to Knox City Council and advocate on multicultural issues.

The Plan outlined Council's commitment to addressing issues affecting multicultural communities in Knox. KMAC assisted Council to monitor the implementation of the Plan. Implementation of the Plan has been the responsibility of various Council departments and was overseen and coordinated by the Community Wellbeing Department.

The key focus areas within the Knox Multicultural Strategic Plan have been integrated into the Knox Community Access and Equity Implementation Plan which was adopted by Council in 2017. This plan aligns and responds to the vision, goals and strategies of the *Knox Community and Council Plan 2017-2021* and is one of its implementation Plans. KMAC will provide advice to Council on the implementation of the Knox Community and Equity Implementation Plan, specifically in relation to actions focusing on multicultural communities.

9.2 Knox Multicultural Advisory Committee Achievements 2012-2017 and Knox Multicultural Strategic Plan 2012-2017 Implementation Outcomes (cont'd)

2. DISCUSSION

2.1 KMAC Activities and Achievements 2012-2017

The objectives of KMAC are to:

- Provide advice and recommendations to Council on multicultural issues in and beyond Knox;
- Identify issues and opportunities affecting people from multicultural backgrounds in and beyond Knox;
- Assist Council in the development of policy, strategy and advocacy initiatives related to the issues and opportunities identified;
- Advocate for increased awareness and understanding of issues and opportunities affecting multicultural communities within Knox;
- Assist Council with its communication, consultation and engagement with multicultural communities through two-way information exchange, from Council to communities and from communities to Council;
- Assist Council to promote and celebrate the benefits of cultural diversity in Knox and to build connections between different cultural groups within the Knox community; and
- Assist Council to monitor the implementation of the Knox City Council Multicultural Strategic Plan 2012-17.

KMAC meets bi-monthly to consider local and broader community multicultural issues and provides advice to Council on a number of initiatives.

An overview of KMAC achievements between 2012-2017, include:

- Advocacy to Knox Council for the development of a strategic plan to address multicultural issues;
- Advice and feedback on various Council plans and strategies and relevant community issues;
- Advice provided on strategies to increase participation of multicultural communities in Knox festivals and events; including engagement with multicultural groups prior to a festival or event;
- The establishment of the Knox Places of Worship Tours working group and program in partnership with the Knox Interfaith Network;
- Increased knowledge between KMAC representatives regarding multicultural services, activities, initiatives and issues experienced by various multicultural groups and individuals in Knox;
- Active participation in the identification of future initiatives to address multicultural issues and opportunities to enhance social cohesion; and

9.2 Knox Multicultural Advisory Committee Achievements 2012-2017 and Knox Multicultural Strategic Plan 2012-2017 Implementation Outcomes (cont'd)

- The development of activities and initiatives within Cultural Diversity Week.

Appendix A of this report details KMAC achievements for each of the Key Areas of the *Knox Multicultural Strategic Plan 2012-2017*.

2.2 The Plan achievements from 2012-2017

The Plan set out Council's commitment to addressing issues affecting multicultural communities in Knox.

In 2010 Council consulted with community members from a range of cultural backgrounds about the issues that affect them and how they could be addressed. Their responses were considered together with government policies and plans to develop the first Knox City Council Multicultural Strategic Plan 2012 – 17. The Plan comprised five key areas:

- Key area one: To strengthen community engagement with multicultural people through effective communication and information provision;
- Key area two: To celebrate multiculturalism and create opportunities that build and support social cohesion in Knox;
- Key area three: To explore and implement initiatives that assist and retain skilled migrants in Knox;
- Key area four: To enhance service panning and service development to meet the identified needs of migrants and refugees; and
- Key area five: To advocate on issues that impact on migrants and refugees in Knox.

Each of the key areas included a goal and a number of proposed actions. Various Knox City Council departments worked with a range of community service organisations, KMAC and community based groups to achieve the goals.

Appendix B presents a detailed summary of key achievements in the delivery of the Plan throughout its 5 years of implementation. Ongoing actions of the Multicultural Strategic Plan have been integrated into the Knox Community Access and Equity Implementation Plan 2017-2022.

In addition to the actions in the Plan a number of additional initiatives were undertaken when the opportunity for partnership projects or funding opportunities arose. These included:

- Engagement with fifty multicultural groups and organisations. This community engagement increased community organisations' access to information regarding Council services and programs, and a greater awareness of other multicultural community organisations' activities and programs;

9.2 Knox Multicultural Advisory Committee Achievements 2012-2017 and Knox Multicultural Strategic Plan 2012-2017 Implementation Outcomes (cont'd)

- Council became a signatory to the Refugee Council of Australia's 'Refugee Welcome Zone' initiative;
- Coordination of Cultural Diversity Taverns within Council to celebrate Cultural Diversity Week. The Taverns have included guest speakers and activities to increase awareness amongst Council staff of some of the issues faced by migrants and refugees; and
- Council signed the Australian Human Rights Commission's 'Racism. It Stops with Me.' Campaign supporter agreement.

3. CONSULTATION

At its bi-monthly meetings KMAC provided advice and contribution on Council plans and initiatives. KMAC informed the review of the KMAC achievements and the development of the Knox Multicultural Strategic Plan implementation outcomes.

4. ENVIRONMENTAL/AMENITY ISSUES

This report has no impact on environmental/amenity issues.

5. FINANCIAL & ECONOMIC IMPLICATIONS

Council's operational budget provides financial support for the Knox Multicultural Advisory Committee and implementation of multicultural activities (totally approximately \$10,000 p/a) and a Multicultural Communities Officer.

6. SOCIAL IMPLICATIONS

As the level of government closest to communities, local government plays a fundamental role in facilitating the inclusion and participation of their residents. Working in partnership with community groups, service providers and residents, Knox Council plays an integral part in enhancing social cohesion. Increased knowledge between KMAC representatives regarding multicultural services, activities, initiatives and issues experienced by various multicultural groups and individuals has an impact on strengthening community connections.

7. RELEVANCE TO KNOX COMMUNITY AND COUNCIL PLAN 2017-2021

This report relates to Goal 7: We are inclusive, feel a sense of belonging and value our identity; and is specifically aligned to the following strategies:

- Strategy 7.2 Celebrate our diverse community
- Strategy 7.3 Strengthen community connections.

9.2 Knox Multicultural Advisory Committee Achievements 2012-2017 and Knox Multicultural Strategic Plan 2012-2017 Implementation Outcomes (cont'd)

8. CONFLICT OF INTEREST

Under section 80c of the Local Government Act 1989 officers providing advice to Council must disclose any interests, including the type of interest.

Officer Responsible – Kathy Parton, Manager Community Wellbeing- In providing this advice as the Officer Responsible, I have no disclosable interests in this report.

Author – Joan Pepi, Multicultural Communities Officer - In providing this advice as the Author, I have no disclosable interests in this report

9. CONCLUSION

Since its establishment in 2009, KMAC has provided leadership in promoting greater awareness and understanding in Council and the community of issues and opportunities in cultural diversity in Knox. The Committee has continued to meet its objectives and assist Council to strengthen its community engagement with the multicultural community. Committee members also provided a key role in the development, monitoring and implementation of the Knox Multicultural Strategic Plan. The implementation of key initiatives between 2012-2017 has seen the creation of links, partnerships and opportunities for multicultural communities thereby contributing to the wellbeing of a culturally diverse municipality. This has set the foundation for the implementation of the *Knox Community Access and Equity Implementation Plan 2017-2022*.

10. CONFIDENTIALITY

No confidentiality issues related to this report.

COUNCIL RESOLUTION

MOVED: CR. LOCKWOOD

SECONDED: CR. KEOGH

That Council

- 1. Notes the achievements of the Knox Multicultural Advisory Committee for the 2012-2017 period as shown at Appendix A; and**
- 2. Notes the outcomes, achievements and challenges of the delivery of the Knox Multicultural Strategic Plan 2012 - 2017 (the Plan) and the actions for that period as shown in Appendix B.**

CARRIED

Appendix A: Knox Multicultural Advisory Committee Achievements 2012-2017

The Knox Multicultural Strategic Plan (the Plan) was developed following feedback from the Knox Multicultural Advisory Committee (KMAC) that research be undertaken with broad community engagement. KMAC believed that a strategic approach would enable the Committee to increase their capacity to provide advice to Knox City Council and to advocate on multicultural issues enhance KMAC's advocacy capacity.

The objectives of the Committee are to:

- Provide advice and recommendations to Council on multicultural issues in and beyond Knox;
- Identify issues and opportunities affecting people from multicultural backgrounds in and beyond Knox;
- Assist Council in the development of policy, strategy and advocacy initiatives related to the issues and opportunities identified;
- Advocate for increased awareness and understanding of issues and opportunities affecting multicultural communities within Knox;
- Assist Council with its communication, consultation and engagement with multicultural communities through two-way information exchange, from Council to communities and from communities to Council;
- Assist Council to promote and celebrate the benefits of cultural diversity in Knox and to build connections between different cultural groups within the Knox community; and
- Assist Council to monitor the implementation of the Knox City Council Multicultural Strategic Plan 2012-17.

KMAC have monitored the implementation of the Plan over the five-year period, providing advice and feedback on specific initiatives, at bi-monthly meetings. KMAC have been involved in the consultation process for a number of Council plans and strategies providing input from a multicultural perspective.

This document details the KMAC achievements for each of the Key Areas of the Multicultural Strategic Plan 2012-2017.

Key Area One: To strengthen community engagement with multicultural people through effective communication and information provision**Achievements**

Provided advice and feedback in relation to:

- the development and distribution of the Multicultural Strategic Plan summary brochures.
- the implementation of the Knox Multicultural Strategic Plan at community meetings.
- enhancement of 'Welcome to Knox Information Kit'.
- the development of the Knox Multicultural Directory.
- the development of the interpreter information cards and the collection of Council's language service data.
- the improvement of Council's website, especially in relation to information available in different languages.
- the review of the Knox Multicultural Advisory Committee Terms of Reference.
- the approach that the Multicultural Communities officers could take to engage with multicultural community groups to assist Council to increase knowledge of activities, challenges and opportunities.
- issues of racial and religious vilification and radicalisation to Victoria Police Eastern Region Community Engagement Unit.

Key Area Two: To celebrate multiculturalism and create opportunities that build and support social cohesion in Knox**Achievements**

Provided advice and feedback in relation to:

- the development of the Knox Multicultural Harmony Festival.
- the Knox Multicultural Harmony Festival Committee.
- the State Government Social Cohesion Grant – building links between multicultural groups and mainstream community groups.
- Knox events – Knox Festival and Stringybark Festival.
- Knox Council Holding Zone project, a film and photography project funded by Multicultural Arts Victoria.
- Knox Places of Worship Working Group which to date has in full delivered eight tours.
- successful grant submission to Multicultural Arts Victoria for the 'Racism-not in my backyard' project, later renamed to 'The Holding Zone'.

In addition, the ongoing dialogue between KMAC members has increased Councils and community members knowledge regarding multicultural services, activities, initiatives and issues experienced by various multicultural groups and individuals in Knox. Collaboration and partnerships between multicultural groups have been developed thereby increasing opportunities for social cohesion.

Key Area Three: To explore and implement initiatives that assist and retain skilled migrants in Knox**Achievements**

Provided advice and feedback in relation to:

- the limited opportunities for migrants to undertake English language classes and work placements.
- Council possibly providing fact sheets on cross-cultural matters to local employers.
- the development and delivery of a Community Mentoring Program facilitated by Council and Swinburne University.

Official Minutes of Knox City Council

Key Area Four: To enhance service planning and development to meet the identified needs of migrants and refugees**Achievements**

Provided feedback into the development of the key Council strategies and projects, including:

- Integrated Transport Plan
- Community Safety Plan
- Healthy Together Knox initiatives
- Youth Strategic Plan
- Affordable Housing
- Home and Community Care Diversity Action Plan
- Knox@50
- Knox Housing Strategy
- Racism. Not in my backyard event
- Community and Council Plan 2017-2021.

Also provided advice and assistance in relation to:

- strategies to increase participation of multicultural communities in Knox festivals and events.
- how local libraries can increase participation of multicultural communities in their services.
- Council's multicultural sports initiative to increase participation of young migrants/refugees in football.
- the implementation of the 'Racism-not in my backyard' event held in partnership with Knox Westfield Shopping Centre.

Key Area Five: To advocate on issues that impact on migrants and refugees in Knox**Achievements***Supported Council's advocacy in relation to:*

- concerns held by Chinese parents and the availability of drugs. The outcome was an information session provided by Knox Youth Services to Chinese parents.
- Australian Federal Government's proposed changes to the Racial Discrimination Act (2017).

Feedback and advice on Council's implementation of:

- the 'Refugee Welcome Zone' project.
- the 'Racism. It Stops with Me.' campaign.

Members of KMAC also represent Council within the:

- Victorian Multicultural Commission's Eastern Regional Advisory Committee.
- Municipal Association of Victoria's Multicultural Committee.

Appendix B
Knox City Council Multicultural Strategic Plan 2012-2017 Achievements

The Knox Multicultural Strategic Plan was developed following feedback from the Knox Multicultural Advisory Committee (KMAC) that research be undertaken with broad community engagement. KMAC believed that a strategic approach would enable the Committee to increase their capacity to provide advice to Knox City Council and to advocate on multicultural issues.

Launched in 2012 the Knox City Council Multicultural Strategic Plan 2012 –2017 (the Plan) comprised five key areas:

Key area one: To strengthen community engagement with multicultural people through effective communication and information provision.

Key area two: To celebrate multiculturalism and create opportunities that build and support social cohesion in Knox.

Key area three: To explore and implement initiatives that assist and retain skilled migrants in Knox.

Key area four: To enhance service planning and service development to meet the identified needs of migrants and refugees.

Key area five: To advocate on issues that impact on migrants and refugees in Knox.

The five key areas included initiatives and actions to address issues impacting on multicultural communities in Knox.

The implementation of the Plan involved collaboration between teams and departments across Council and key external stakeholders to work in collaboration. The Multicultural Communities Officer was responsible for overseeing the development and delivery of the Plan. The KMAC was instrumental in providing feedback and guidance on the Plan's implementation.

This document details the achievements of the Plan from 2012-2017.

Key Area One: To strengthen community engagement with multicultural people through effective communication and information provision		
Initiatives and Key Achievements		
Initiative	Actions	Key Achievements
Welcome to Knox Information Kit	Explore opportunities to provide information through existing New Residents Kits.	Feedback to Communications Department regarding information to be included.
Enhance website accessibility for multicultural residents	Review and expand current content on Council's website to include local activities.	<ul style="list-style-type: none"> List of English language classes available in the municipality included on Knox website. Promotion of community events.
Multilingual Communications	Continue the use of: <ul style="list-style-type: none"> Translating and Interpreting Service for core Council business All Graduates Interpreting and Translating Service for Maternal and Child Health services On Call Interpreting and Translating Service (HACC credit line) 	<ul style="list-style-type: none"> Knox website provides information about interpreters and translators in 10 different languages. Interpreter and translator information displayed at Council customer service counters. Customer Service staff engage with non-English speaking residents via interpreters when required. Community organisation and staff training on the use of interpreters. Language service cards developed in 10 different languages and distributed to relevant staff. Community organisation training regarding the use of interpreters.

Key Area One: To strengthen community engagement with multicultural people through effective communication and information provision (cont'd)

Initiatives and Key Achievements

<i>Initiative</i>	<i>Actions</i>	<i>Key Achievements</i>
Multilingual Communications (cont'd)		<ul style="list-style-type: none"> • Development and implementation of the Knox staff resource guide 'Communicating with non-English speaking residents'. • Information sessions to Council departments on working with interpreters. • Delivery of training session to InfoLink on working with interpreters.
Engagement with Knox Multicultural Advisory Committee (KMAC)	Continue to engage with KMAC on a regular basis.	<ul style="list-style-type: none"> • Knox Multicultural Advisory Committee continues to meet bi-monthly to provide advice and recommendations to Council on multicultural issues. • A comprehensive selection process and induction program of new members recruited to KMAC has increased engagement and participation.

Key Area 2: To celebrate multiculturalism and create opportunities that build and support social cohesion in Knox

Initiatives and Key Achievements

<i>Initiative</i>	<i>Actions</i>	<i>Key Achievements</i>
<p><i>Social Support</i></p>	<p>Continue and strengthen opportunities for the establishment of ethno-specific groups for migrants and refugee communities in Knox; e.g. playgroups, seniors groups</p>	<p>Council provides ongoing support to ethno-specific seniors groups including the Hungarian, Chinese, Italian and Polish.</p> <p>Council has worked with local football clubs to assist in developing strategies to increase participation of young people from migrant and refugee backgrounds.</p> <p>Promotion of multicultural community activities and programs on Council's website.</p> <p>Assistance provided to the Scoresby Cricket Club for the delivery of the Multicultural Cricket Tournament.</p> <p>Assistance to Chinese Community Social Services Centre who coordinates a Planned Activity Program for older Chinese residents.</p> <p>Migrant Information Centre's Access and Support Program provides support to Knox multicultural residents.</p> <p>An increase in the number of multicultural community organisations applying for Council's Community Development Fund.</p>

Key Area 2: To celebrate multiculturalism and create opportunities that build and support social cohesion in Knox (cont'd)

Initiatives and Key Achievements

<i>Initiative</i>	<i>Actions</i>	<i>Key Achievements</i>
Social Support	Continue the collection and dissemination of information relevant to multicultural residents, organisations and service providers. Maintain the Knox Multicultural e-Network.	Monthly distribution of the Knox Multicultural e-bulletin to 96 recipients.
	Develop the HACC Diversity Plan	Developed and implemented annually.
Local media	Promote 'good news' stories in local media and ward newsletters.	'Good news' stories shared in the CEO Bulletin, social media, Knox News and eRIK.
Knox Inter-faith Network	Continue to support the Knox Inter-faith Network.	Ongoing support by Council to the Knox Interfaith Network. Free use of a meeting room. Officer support to set up working groups as required and provide links to KMAC. Annual KMAC/KIN meeting to enhance collaboration of multicultural programs/activities and new initiative development. Community Development Fund grant for the KIN website upgrade. Coordination of 8 tours of Places of Worship.

Key Area 2: To celebrate multiculturalism and create opportunities that build and support social cohesion in Knox (cont'd)

Initiatives and Key Achievements

<i>Initiative</i>	<i>Actions</i>	<i>Key Achievements</i>
Events	Engage with multicultural residents in Knox City Council's events and community events such as Knox Festival, Citizenship Ceremonies, Senior Citizens Week and Cultural Diversity Week.	<p>Council funding for Open Mosque Day and ISOMER in 2016.</p> <p>'Multicultural Forum – cultural across the generations' held during Cultural Diversity Week in 2017 with 60 people in attendance.</p> <p>5288 residents took up citizenship.</p> <p>Increased participation of multicultural groups in Council events and festivals.</p> <p>Development of the Multicultural Festival and Event Guide for Council staff.</p> <p>Refugee Week acknowledged with various activities, including the viewing of 'Constance on the Edge', a portrayal of a group of African Australians, from refugee backgrounds, settling in Australia.</p>

Key Area 2: To celebrate multiculturalism and create opportunities that build and support social cohesion in Knox (cont'd)		
Initiatives and Key Achievements		
Initiative	Actions	Key Achievements
Events (cont'd)		<p>'Understanding Racism" information session provided to Council staff.</p> <p>Council signed up to the Australian Human Rights Commission 'Racism. It Stops with Me.' Campaign activities included:</p> <ul style="list-style-type: none"> - Community Safety Day at Ozone in Oct 2014. - The Holding Zone project funded by Multicultural Arts Victoria.
Knox City Council Community Development Grants	Council grants support projects for multicultural groups	Increased information provided regarding Council's Community Development Fund grant to multicultural groups. There has been a 30% increase since 2016 in the number of groups that applied for and were successful in receiving funding. Examples of projects funded include – Holi – The Festival of Colour Celebration, Diwali Celebration, Iftar Dinner, Hungarofest, Weihnachtsmarkt German Christmas Market.

Key Area Three: To explore and implement initiatives that assist and retain skilled migrants in Knox

Initiatives and Key Achievements

<i>Initiative</i>	<i>Actions</i>	<i>Key Achievements</i>
Small business mentoring program	Support the establishment of a mentoring program through Swinburne TAFE to assist skilled migrants in local businesses in Knox.	A Mentoring Program facilitated in partnership with Swinburne, Wantirna campus in 2012.
Social support for families	Promote social supports available for families (grandparents) and spouses of skilled migrants.	<p>The Rowville Chinese Friendship Group and the Knox Library Chinese Social Club supported by the respective libraries.</p> <p>Eastern Migrant Information Centre coordinated a homework support group at the Knox library. This program targeted refugee and family stream migrants.</p> <p>Council's Youth Services Team engaged with Chinese parents and youth to explore the anxieties in the Chinese community about ways of parenting young Chinese teenagers.</p> <p>One Japanese and two Chinese Playgroups established.</p>
Additional initiative	Provide support to the 'My Choice My Life – Youth Forum'	Held in 2017 the 'My Choice My life – Youth Forum', with 180 participants, focused on job interview skills, pathways to university, Australian workplace law.

Key Area Four: To enhance service planning and development to meet the identified needs of migrants and refugees		
Initiatives and Key Achievements		
Initiative	Actions	Key Achievements
To enhance service planning and service development to meet the identified needs of migrants and refugees	Continue to build on the demographic data relating to migrants and refugees in the Knox community.	Up to date demographic data made available to Council officers and community organisations on Council website. Information received via the MAV Multicultural Issues e-network, Diversity in HACCC eNetwork, Ethnic Communities Council of Victoria. Relevant information distributed to the Knox Multicultural Advisory Committee and via the Multicultural ebulletin to community members.
	Council officer to attend Victorian Local Government Multicultural Issues Network (VLGMIN) meetings and represent Knox issues.	Attendance and contribution to the Victorian Local Government Multicultural Network meetings – attended an average of 5 meetings per year.
	Council officer to attend Eastern Migrant Settlement Committee (MSC) meetings.	Attendance and participation in the planning of regional forums at the Eastern Migrant Settlement Committee meetings – attended an average of 8 meetings per year.
	Council officer to receive information via the Municipal Association of Victoria Multicultural Issues e-network.	MAV Multicultural Issues e-bulletins received monthly. Relevant information distributed via Knox Multicultural e-bulletin and to relevant Council officers.
	Council officer to attend Eastern Metropolitan Region Multicultural Aged Care network.	Active Ageing and Disability Services Council officer attends on regular basis; receive agendas and minutes and distribute information where relevant.

Key Area Five: To advocate on issues that impact on migrants and refugees in Knox		
Initiatives and Key Achievements		
Initiative	Actions	Key Achievements
To advocate on issues that impact on migrants and refugees in Knox	Create opportunities for the Knox Multicultural Advisory Committee (KMAC) to communicate the identified issues on housing affordability and rental availability for migrants and refugees to the Knox Affordable Housing Reference Group (AHRG) and the Eastern Affordable Housing Alliance (EAHA) (invite representatives of these groups to KMAC).	Input into Council's Housing Strategy.
	Create opportunities for the Knox Multicultural Advisory Committee to communicate the identified issues of migrants and refugees to the Eastern Transport Coalition (ETC).	Facilitated opportunities for KMAC to provide feedback on issues to ETC.
To advocate on issues that impact on migrants and refugees in Knox (cont'd)	Create opportunities for the Knox Multicultural Advisory Committee to communicate identified needs of migrants and refugees to other Council groups, such as Knox Healthy Ageing Advisory Committee, Recreation and Leisure Liaison Group and Knox Arts and Cultural Development Advisory Committee.	Facilitated opportunities for KMAC to advocate on various Council initiatives and programs. These have included: <ul style="list-style-type: none"> • Community Safety • Family Violence • Housing Strategy • Events guidelines for the inclusion of the multicultural community • 'Preventing homelessness for older CALD people' forum.

Key Area Five: To advocate on issues that impact on migrants and refugees in Knox (cont'd)

Initiatives and Key Achievements

<i>Initiative</i>	<i>Actions</i>	<i>Key Achievements</i>
To advocate on issues that impact on migrants and refugees in Knox (cont'd)	Create opportunities for the Knox Multicultural Advisory Committee to communicate identified needs of migrants and refugees to other Council groups, such as Knox Healthy Ageing Advisory Committee, Recreation and Leisure Liaison Group and Knox Arts and Cultural Development Advisory Committee.	Facilitated opportunities for KMAC to advocate on various Council initiatives and programs. These have included: <ul style="list-style-type: none"> • Community Safety • Family Violence • Housing Strategy • Events guidelines for the inclusion of the multicultural community • 'Preventing homelessness for older CALD people' forum.

ALL WARDS

10.1 2017-18 ANNUAL PLAN PROGRESS REPORT TO 31 DECEMBER 2017

SUMMARY: *Business Intelligence Officer (Carrie Hudson)*

This report provides the second quarter progress on initiatives identified in the 2017-18 Annual Plan. The Annual Plan for 2017-18 was adopted by Council at the Ordinary Meeting of Council on 26 June 2017 as part of the 2017-18 Annual Budget. The Annual Plan satisfies the requirements of the Local Government Act 1989 by outlining the services provided by Council and the initiatives that Council will complete in the 2017-18 year.

The Annual Plan progress report only reports on those initiatives identified in the Annual Plan and Annual Budget process, it is not a comprehensive report on all of Council's activities.

RECOMMENDATION

That Council receive and note the 2017-18 Annual Plan progress report for the period 1 October to 31 December 2017.

1. INTRODUCTION

An Annual Plan was established for the 2017-18 financial year to assist in the achievement of the goals of the Community and Council Plan 2017-21. The 2017-18 Annual Plan progress report to 31 December 2017 (see Appendix A) reports on the initiatives that support those goals.

2. DISCUSSION

Appendix A (attached) provides the Annual Plan progress report for the second quarter of 2017-18.

Q2 2017-18 Results:

Of the 31 initiatives included in the 2017-18 Annual Plan:

- 17 initiatives are on schedule
- 9 initiatives have fallen behind schedule and require monitoring
- 4 initiatives are complete
- 1 initiative is not proceeding due to unsuccessful funding application

Significant progress is expected in the second half of the year for many of the initiatives behind schedule. Knox is confident that the majority of initiatives will be delivered as expected by the end of the year.

10.1 2017-18 Annual Plan Progress Report to 31 December 2017 (cont'd)**The initiatives currently below target are:**

1. Explore a range of mechanisms to improve and encourage high quality and sustainable design in the built form.
2. Undertake a strategic review of Council's parking compliance services to review current parking compliance issues within the municipality, and provide strategies and recommendations to address them.
3. Investigate community transport services and availability in Knox to determine requirement for funding advocacy to increase community transport options delivered by community agencies.
4. Deliver health promotion and harm minimisation programs
5. Develop an Aquatic Plan.
6. Relocate the Knox City Library service and Youth Information Centre within Knox Westfield.
7. Implement staged delivery of the ICT Roadmap to support organisational efficiency and effectiveness and to increase capacity for customer self-service.
8. Finalise and implement Council's Communication Strategy.
9. Facilitate regular networking sessions with key agencies and stakeholders to identify partnership opportunities in order to achieve shared Community and Council Plan goals.
10. Implement the Business Champions of Change Project on family violence prevention with three businesses across Outer East. (not moving forward)

Progress comments on all initiatives can be found in Appendix A.

3. CONSULTATION

The 2017-18 Annual Plan actions are linked to, and support the delivery of, the Community and Council Plan 2017-21. Significant community engagement was incorporated into the development of the Community and Council Plan 2017-21.

The Annual Plan 2017-18, including the initiatives, was approved as part of the Annual Budget after public consultation on 26 June 2017.

4. ENVIRONMENTAL/AMENITY ISSUES

There are no direct environmental/amenity issues arising from this report. A number of initiatives within the 2017-18 Annual Plan seek to have a positive impact on environmental issues within the Knox municipality.

5. FINANCIAL & ECONOMIC IMPLICATIONS

There are no direct financial and economic implications arising from this report. Changes in specific projects are reported through Capital Works and Budget processes.

10.1 2017-18 Annual Plan Progress Report to 31 December 2017 (cont'd)**6. SOCIAL IMPLICATIONS**

There are no direct social implications arising from this report. A number of initiatives within the 2017-18 Annual Plan seek to have a positive social impact within the Knox municipality.

7. RELEVANCE TO KNOX COMMUNITY AND COUNCIL PLAN 2017-2021

The Annual Plan aligns to **Goal 8: We have confidence in our decision making**, of the Community and Council Plan 2017-21. Monitoring performance against the plan allows us to have confidence in our decision making.

8. CONFLICT OF INTEREST

Under section 80c of the Local Government Act 1989 officers providing advice to Council must disclose any interests, including the type of interest.

Officer Responsible – (Michael Fromberg, Director Corporate Services) - In providing this advice as the Officer Responsible, I have no disclosable interests in this report.

Author – (Carrie Hudson, Business Intelligence Officer) - In providing this advice as the Author, I have no disclosable interests in this report

9. CONCLUSION

There has been good progress made on the majority of Annual Plan initiatives in quarter two 2017-18, with 21 of the 31 initiatives on or ahead of schedule.

10. CONFIDENTIALITY

There are no issues of confidentiality associated with this report.

COUNCIL RESOLUTION

MOVED: CR. PEARCE
SECONDED: CR. KEOGH

That Council receive and note the 2017-18 Annual Plan progress report for the period 1 October to 31 December 2017.

CARRIED

Annual Plan Progress Report

Q2 2017-18

1 October to 31 December 2017



2017-18 Annual Plan Progress Report - Quarter Two (October to December 2017)

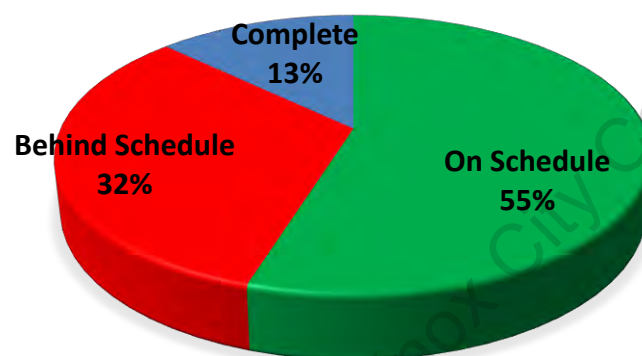

Goal	On Schedule	Behind Schedule	Complete
1. We value our natural and built environment	4	0	0
2. We have housing to meet our changing needs	2	1	0
3. We can move around easily	1	2	0
4. We are safe and secure	1	1 (not moving forward)	2
5. We have a strong regional economy, local employment and learning opportunities	2	0	0
6. We are healthy, happy and well	1	2	0
7. We are inclusive, feel a sense of belonging and value identity	6	1	0
8. We have confidence in decision making	0	3	2
Total	17	10	4

The overall progress completion percentage of each initiative is calculated by the combined progress of the associated milestones.

Goal 1: We value our natural and built environment

Initiative Description		Department	Q2 Target	Progress
Identify and commence implementation of strategic and appropriate locations for dog parks in Knox.		Community Infrastructure	25%	35%
Progress Comment:				
A consultant has been appointed to undertake the Knox Strategic Dog Plan and Policy Investigation. Initial research and review of relevant background documents has commenced and draft key principles and criteria have been tabled by the consultants. Implementation works are expected to begin in 2018-19, subject to funding.				
Initiative Milestones	Description	Start date	End date	Progress
	Appointment of consultant.	01-07-2017	15-10-2017	100%
	Undertake initial research including a review of relevant strategies and policies and undertake initial consultation.	16-10-2017	15-11-2017	15%
	Preparation of draft key principles and criteria to guide the design and siting process. Undertake initial site identification, assessment and evaluation.	15-12-2017	15-02-2018	25%
	Preparation of a draft Plan including estimates of cost (establishment and operation/maintenance). Consultation sought on the draft and preparation of the final Plan.	16-02-2018	15-04-2018	Not Started
YTD Actual		YTD Budget	Initiative Budget	
\$ -		\$15,000	\$30,000	

Initiative Description		Department	Q2 Target	Progress
Increase the provision of public place recycling bins across the municipality.		Sustainable Infrastructure	25%	25%
Progress Comment:				
Recycling bin placement design and installation has been completed in conjunction with the Bayswater streetscape works. Other areas are to follow.				
Initiative Milestones	Description	Start date	End date	Progress
	Consultation with Council departments involved in reserve, shopping centre and streetscape upgrade works and maintenance (as applicable) – to identify appropriate locations for new recycling bins.	01-10-2017	30-06-2018	25%
	Supply and install new bins at priority locations as identified by internal stakeholders and waste collection contractors. Refer balance of new bins to the 2018-19 operating budget.	01-12-2017	30-06-2018	25%
YTD Actual		YTD Budget	Initiative Budget	
			No additional budget, sits within current operating budget.	

Initiative Description		Department	Q2 Target	Progress
Undertake a strategic review of the Boronia Structure Plan including a detailed assessment of strategic sites (i.e. Boronia Park).		City Futures	50%	50%
Progress Comment:				
Council adopted the project plan and scope on 11 September 2017. A preliminary Key Directions report is being prepared based on data collected to date. Community engagement commenced in October 2017 with 540 survey outcomes and six charette workshops to be delivered in January and February 2018. A Social Demographic Profile based on the 2016 census has been prepared. The Community Services and Facilities Review has been prepared and is now being broadened to include non-council organisations to build a more comprehensive understanding of service delivery in Boronia. A Mapping and Audit of Council owned Assets and Services report which has been combined with another project to avoid duplication to become BAMP for Boronia (Building Asset Management Plan); and a Boronia – Economic Demand, Land and Site Options Analysis Report has been prepared by HillPDA consulting				
Initiative Milestones	Description	Start date	End date	Progress
	Scope development and approval by Council.	01-07-2017	11-09-2017	100%
	Key Directions Report development and Council approval.	01-08-2017	30-03-2018	50%
	Draft Boronia Strategic Community Plan prepared.	01-03-2018	30-06-2018	Not started
YTD Actual		YTD Budget	Initiative Budget	
\$56,625.91		\$ -	\$390,000	

Initiative Description		Department	Q2 Target	Progress
Finalise and implement a public arts plan for Knox.		Youth, Leisure and Cultural Services	60%	71%
Progress Comment:				
The Public Arts Implementation Plan and associated Public Arts Policy were adopted by Council at its Ordinary meeting on 23 October 2017. Implementation will be commencing with the establishment of a Public Art Assessment Panel in early 2018.				
Initiative Milestones	Description	Start date	End date	% Complete
	Finalise report and present to Council.	01-07-2017	18-09-2017	100%
	Report adopted by Council.	18-09-2017	23-10-2017	100%
	Implement the Action Plan.	01-12-2017	30-06-2018	15%
YTD Actual		YTD Budget	Initiative Budget	
Derived from various programs.				

Goal 2: We have housing to meet our changing needs

Initiative Description		Department	Q2 Target	Progress
Continue to support the development of Stamford Park residential estate.		City Futures	30%	30%
Progress Comment:				
The filling of the site is nearing completion and the Development Plan for the site has been approved. Until the site is filled, and the site levels surveyed, no formal action with regard to the planning scheme amendment can be taken. Discussions have progressed with Stockland in relation to a way forward, and the amendment process that will best fit the outcome. Progress continues with the cross Council Intergenerational parklands project with the engagement of Swinburne University to partner on active ageing elements.				
Initiative Milestones	Description	Start date	End date	Progress
	Planning Scheme Amendment to remove LSIO from Stamford.	01-10-2017	30-06-2018	30%
YTD Actual		YTD Budget	Initiative Budget	
\$19,002.74		\$71,628	\$148,185	

Initiative Description		Department	Q2 Target	Progress
Explore a range of mechanisms to improve and encourage high quality and sustainable design in the built form.		City Futures	45%	40%
Progress Comment:				
Urban Design Consultancy continue to be used on a range of significant applications. Recommendations are incorporated in planning decisions and recommendations. A business case for the delivery of an Urban Design Forum and Workshop series will be considered during budget deliberations in February 2018.				
Initiative Milestones	Description	Start date	End date	Progress
	Continued use of consultancy Urban Design Advice for relevant planning applications.	01-07-2017	30-06-2018	50%
	Delivery of Urban Design Forum and Workshop series (as per 24/7/2017 Council Report).	01-11-2017	30-06-2018	30%
YTD Actual		YTD Budget	Initiative Budget	
\$ 19,296.55		\$12,000	\$50,000	

Initiative Description		Department	Q2 Target	Progress
Implement the Affordable Housing Action Plan including advocacy for an increase for the supply of social and affordable housing at key strategic sites and across the municipality.		Community Wellbeing	50%	52%
Progress Comment:				
<p>A 5% voluntary social housing component has been achieved at the Kingston Links site through the supply of land on the site and a substantial financial contribution to increase the supply of social housing in Knox.</p> <p>There has been ongoing advocacy to the State Government to adopt 'inclusionary zoning' including correspondence to the Ministers for Planning and Housing, numerous discussions with relevant bureaucrats responsible for public and social housing and the implementation of 'Homes for Victorians' and input into advocacy undertaken by the Eastern Affordable Housing Alliance (of which Knox City Council is an active member).</p>				
Initiative Milestones	Description	Start date	End date	Progress
	Negotiate with developers for a 5% voluntary social housing component for Kingston.	01-07-2017	30-09-2017	100%
	Advocate for 'inclusionary zoning' to increase the supply of social housing in Knox.	01-07-2017	30-06-2018	50%
	Prepare the 2017 annual Housing Monitoring Report.	01-07-2017	30-06-2018	10%
YTD Actual		YTD Budget	Initiative Budget	
No additional budget, sits within current operating budget.				

Official Minutes of Knox City Council

Goal 3: We can move around easily

Initiative Description		Department	Q2 Target	Progress
Undertake a strategic review of Council's parking compliance services to review current parking compliance issues within the municipality, and provide strategies and recommendations to address them.		City, Safety and Health	25%	16%
Progress Comment:				
The Parking Enforcement Strategy project brief has been prepared. This document is to provide scope for consultants for the Expression Of Interest (EOI).				
Initiative Milestones	Description	Start date	End date	Progress
	Project scope finalised.	01-07-2017	31-12-2017	50%
	Appoint a consultant and prepare strategy.	01-01-2018	28-02-2018	Not started
	Prepare draft report and present to Council.	01-07-2017	30-06-2018	Not started
YTD Actual		YTD Budget	Initiative Budget	
\$ -		\$ -	\$60,000	

Initiative Description		Department	Q2 Target	Progress
Investigate community transport services and availability in Knox to determine requirement for funding advocacy to increase community transport options delivered by community agencies.		Active Ageing and Disability Services	50%	25%
Progress Comment:				
Initial discussions on data collection and opportunities have begun. Data on current services is to be completed by the end of February 2018. A meeting is organised early in the new year to plan a forum for 2018. The forum will allow for local agencies to meet and discuss opportunities that will feed into the development of recommendations for future action and advocacy.				
Initiative Milestones	Description	Start date	End date	Progress
	Identify the current availability of community transport/not for profit/volunteer services in the Knox region and identify gaps/opportunities.	01-11-2017	28-02-2018	25%
	Investigate existing collaborative opportunities to work with local agencies to support changing transport needs of older residents and prepare a report with recommendations for future action and advocacy.	01-11-2017	30-06-2018	25%
YTD Actual		YTD Budget	Initiative Budget	
No additional budget, sits within current operating budget.				

Initiative Description		Department	Q2 Target	Progress
Advocate to State and Federal Governments for improved sustainable transport infrastructure and services.		Sustainable Infrastructure	25%	31%
Progress Comment:				
Council officers met with representatives from Public Transport Victoria, Transport for Victoria and the Active Transport Unit to discuss regional priorities for Melbourne's East as part of a delegation from the Eastern Transport Coalition. Officers are currently progressing work in identifying priority bus needs within Knox, which will inform a targeted advocacy campaign in the latter part of the financial year. A promotional video through the Eastern Transport Coalition featuring bus needs in Knox is currently being completed for posting through social media. Direct advocacy efforts have been made with the State Government calling for delivery of a shared path along Burwood Hwy, between Eastlink and Morack Road to provide greater connectivity in the network.				
Initiative Milestones	Description	Start date	End date	Progress
	Identification, justification and prioritisation of each of Council's transport priorities.	01-12-2017	28-02-2018	60%
	Support the development of messaging for purposes of advocacy.	01-12-2017	31-03-2018	40%
	Support the delivery of Council's sustainable transport advocacy messages – through Council and the Eastern Transport Coalition (ETC).	01-12-2017	30-06-2018	25%
	Advocate key transport priorities to relevant Ministers and local MPs and candidates in the lead up to the 2018 State election through Council and the Eastern Transport Coalition (ETC).	01-04-2018	30-06-2018	Not started
YTD Actual	YTD Budget	Initiative Budget		
No additional budget, sits within current operating budget.				

Goal 4: We are safe and secure

Initiative Description		Department	Progress	
Develop and participate in a Council and community program for the 16 days of Activism against gender violence.		Community Wellbeing	 Complete	
Progress Comment:				
The launch of the 16 days of Activism and morning tea was held on 22 November with approximately 50 community and staff attending. Guest speakers included Heather McTaggart Knox Ambassador, Knox City Council's Mayor and CEO. Suzi Hayes also provided an update on the Listen, Learn and Lead Gender Equity Program. Knox was the only Council to hold a launch of the 16 Days of Activism to raise awareness of gender inequality and its impact on family violence. A review of the event will be included following an analysis of the online campaign.				
Initiative Milestones	Description	Start date	End date	Progress
	Scope Development.	01-07-2017	01-10-2017	100%
	Communication of promotional material.	01-11-2017	30-12-2017	100%
	Implementation of the program.	23-11-2017	30-12-2017	100%
YTD Actual		YTD Budget	Initiative Budget	
No additional budget, sits within current operating budget.				

Initiative Description		Department	Q2 Target	Progress
Continue to implement the Victorian Child Safe Standards		Corporate Development	50%	75%
Progress Comment:				
A Child Safe Implementation Plan has been developed and endorsed by the Executive Management Team (EMT). Implementation has commenced with a draft Child Safe Policy and Reporting Procedure in the process of being developed and finalised. A Child Safe Communication Plan has been developed and endorsed by EMT. Implementation is underway with Child Safe briefings occurring as part of the CEO's Briefing and Senior Managers Forum and the draft Child Safe Statement of Commitment in the process of being finalised.				
Initiative Milestones	Description	Start date	End date	Progress
	Finalise an EMT approved Child Safe Standards Implementation Plan.	01-07-2017	31-12-2017	100%
	Establish and implement an internal Communication Plan, information and support for the process.	01-07-2017	30-06-2018	50%
YTD Actual		YTD Budget	Initiative Budget	
No additional budget, sits within current operating budget.				

Initiative Description		Department	Progress	
Implement a Graffiti reporting system (mobile app) in partnership with other Metropolitan Councils.		Community Wellbeing		Complete
Progress Comment:				
<p>The vandaltrack app has been commissioned and uploaded to Council and Police systems. Police are currently utilising the information as a tool to track graffiti offenders and locations.</p> <p>The app was launched via social media and through local newspapers. The uptake and use by the community will be monitored over the next six months and further social marketing will be rolled out during this time.</p>				
Initiative Milestones	Description	Start date	End date	Progress
	Implementation of the mobile app.	01-07-2017	30-06-2018	100%
	Launch of the Graffiti reporting system mobile app.	01-10-2017	30-10-2017	100%
YTD Actual		YTD Budget	Initiative Budget	
\$2,000		\$2,000	\$ 2,000	

Initiative Description	Department	Q2 Target	Progress
Implement the Business Champions of Change Project on family violence prevention with three businesses across Outer East. (subject to grant funding)	Community Wellbeing		
Progress Comment:			
Grant funding for the delivery of this initiative was not successful- the project will not proceed on this basis.			

Goal 5: We have a strong regional economy, local employment and learning opportunities

Initiative Description		Department	Q2 Target	Progress
Develop and regularly update a Knox Investment Plan to support Council's advocacy program and activities.		Communications & Customer Service	75%	80%
Progress Comment:				
Version one of The Knox Investment Plan document is now complete. The plan will be reviewed in February 2018 and again in June 2018.				
Initiative Milestones	Description	Start date	End date	Progress
	Develop version one of the Knox Investment Plan.	01-7-2017	30-10-2017	100%
	First review of the Knox Investment Plan.	01-02-2018	28-02-2018	0%
	Second review of the Knox Investment Plan.	01-06-2018	30-06-2018	0%
YTD Actual		YTD Budget	Initiative Budget	
No additional budget, sits within current operating budget.				

Initiative Description		Department	Q2 Target	Progress
Advance the planning for the Wantirna Health Precinct in partnership with the Metropolitan Planning Authority and Department of Economic Development, Jobs, Transport and Resources.		City Futures	20%	30%
Progress Comment:				
A revised scope has now been prepared. Whilst originally it was anticipated that the Victorian Planning Authority (VPA) would lead, it has since been agreed that Knox will take the lead and a project plan/brief for a Wantirna Health Structure Plan has been completed. Officers are meeting with the VPA, Eastern Health and DHHS in January to seek feedback on the project plan/brief and to seek financial or other assistance to further the development and progression of the Structure Plan.				
Initiative Milestones	Description	Start date	End date	Progress
	Scope the development of a Structure Plan for Wantirna Health Structure Plan.	01-10-2017	30-12-2017	50%
	Conduct a stakeholder forum to determine urban form development agenda and progress the preparation of an Urban Form Concept Plan for the precinct.	01-12-2017	30-06-2018	10%
YTD Actual		YTD Budget	Initiative Budget	
\$ -		\$34,498.00	\$60,000.00	

Goal 6: We are healthy, happy and well

Initiative Description		Department	Q2 Target	Progress
Deliver health promotion and harm minimisation programs, including: <ul style="list-style-type: none"> • Education /capacity building programs with sporting clubs focused on cultural change; and • Advocacy to improve planning policy responses and regulatory framework that manage the density of alcohol outlets within places or locations. 		Community Wellbeing	50%	42%
Progress Comment:				
Advocacy on health promotion and harm minimisation programs have been built into the Knox Community Investment Plan. Council continues to advocate to the state government for legislative change on health issues relevant to Knox. A report on a strategy to address packaged alcohol outlets and links to harmful alcohol use was approved by Council in December 2017. A program Coordinator for sporting club development around health and wellbeing has been appointed, commencing in January 2018 to lead the program and be involved in the selection of the preferred contractor.				
Initiative Milestones	Description	Start date	End date	Progress
	Delivery of the Sports Club Culture Development Program.	01-07-2017	30-06-2018	35%
	Development of an Advocacy campaign on health promotion issues.	01-07-2017	30-06-2018	50%
YTD Actual		YTD Budget	Initiative Budget	
\$33,202,227.50		\$38,724,270.82	\$107,265,177	

Initiative Description		Department	Q2 Target	Progress
Progress Council's public Expression of Interest process seeking applications from NDIS/ECIS service providers to lease the Illoura House facility for use as a disability focused centre supporting children, families, carers and people with disabilities in Knox.		Financial Services	75%	92%
Progress Comment:				
Public Notice of the intention to lease was advertised in December 2017, with submissions closing 10 January 2018. A final report will be presented to Council in February.				
Initiative Milestones	Description	Start date	End date	Progress
	Complete EOI Process.	01-07-2017	30-09-2017	100%
	Report to Council.	01-10-2017	30-11-2017	85%
YTD Actual		YTD Budget	Initiative Budget	
No additional budget, sits within current operating budget.				

Initiative Description	Department	Q2 Target	Progress
Develop an Aquatic Plan.	Youth, Leisure and Cultural Services		Commenced but full completion delayed until late 2018.
Progress Comment:			
<p>The Aquatic Plan analysis has commenced but is now on hold to allow the completion of a structural building assessment for the Leisureworks facility. This approach was discussed and endorsed by the Executive Management Team (EMT). The outcome of the structural assessment is seen as critical in order to explore future aquatic facility options. The project is now to be completed by October 2018. Approval of this timeframe adjustment has been supported by the contributing funding body, State Recreation Victoria (SRV).</p>			

Official Minutes of Knox City Council

Goal 7: We are inclusive, feel a sense of belonging and value identity

Initiative Description		Department	Q2 Target	Progress
Further develop partnerships with community houses for extended programming related to digital literacy.		Community Wellbeing	50%	50%
Progress Comment:				
The February Learn Local Network meeting was deferred from February 2018 to March 2018. Analysis of current courses available is being undertaken and will form part of the March meeting agenda.				
Initiative Milestones	Description	Start date	End date	Progress
	Consult with community houses.	01-09-2017	31-12-2017	50%
	Develop project scope, including mapping and partnership opportunities.	01-12-2017	31-01-2018	50%
	Support partnerships and project development.	01-02-2018	30-06-2018	50%
YTD Actual		YTD Budget	Initiative Budget	
No additional budget, sits within current operating budget.				

Initiative Description		Department	Q2 Target	Progress
Support the development of the new The Basin Community House on The Basin Primary School site.		Community Wellbeing	50%	67%
Progress Comment:				
This project is led by the State Department of Education and Training (DET). The tender assessment and allocation is now complete and the Planning Amendment has been submitted. Construction work is scheduled to begin in early 2018.				
Initiative Milestones	Description	Start date	End date	Progress
	Tender assessment and allocation	01-07-2017	15-11-2017	100%
	Submit the Planning Amendment	01-07-2017	31-01-2017	100%
	Construction of the building	16-11-2017	30-06-2018	Not Started
YTD Actual		YTD Budget	Initiative Budget	
No additional budget, sits within current operating budget. Capital contribution from Council will relate to furniture and fittings.				

Initiative Description		Department	Q2 Target	Progress
Finalise the review of Council's Community Operational Funding Program.		Community Wellbeing	50%	62%
Progress Comment:				
The report reviewing Council's Community Operational Funding Program was presented to EMT on 4 December 2017 and is scheduled to be presented to Council on 22 January 2017				
Initiative Milestones	Description	Start date	End date	Progress
	Report presented to EMT.	01-10-2017	30-10-2017	100%
	Report presented to Council.	01-11-2017	30-01-2018	90%
	Implementation of identified changes.	01-03-2018	30-06-2018	Not Started
YTD Actual		YTD Budget	Initiative Budget	
No additional budget, sits within current operating budget.				

Initiative Description		Department	Q2 Target	Progress
Develop a streamlined approach and tools to support community members holding community events and festivals on Council land.		Youth, Leisure and Cultural Services	50%	80%
Progress Comment:				
Process mapping is now complete. Internal Key stakeholders identified opportunities for process improvement and central coordination of a service model. A preferred process has been constructed with internal key stakeholders, using a centralised service model to coordinate customer enquiries across up to 11 different units for event support, approvals and permits. The new service model and resources are currently being further developed with a contractor with the aim to implement the new process and tools from July 2018, business case pending.				
The preferred model for the event guide is now developed, using the low/medium/high impact category for event management. A contractor has been appointed to assist building this guide and work is now progressing.				
Initiative Milestones	Description	Start date	End date	Progress
	Undertake process mapping of the current Council system for community run events on Council land.	01-07-2017	31-01-2018	100%
	Develop Events guide.	01-07-2017	30-06-2018	60%
YTD Actual		YTD Budget	Initiative Budget	
No additional budget, sits within current operating budget.				

Initiative Description		Department	Q2 Target	Progress
Relocate the Knox City Library service and Youth Information Centre within Knox Westfield.		Youth, Leisure and Cultural Services	60%	36%
Progress Comment:				
Awaiting handover to occur prior to Council taking charge of the internal fit for the interim building. Work is currently progressing on the longer term building design of the permanent facility.				
Initiative Milestones	Description	Start date	End date	Progress
	Complete detailed design.	01-07-2017	30-09-2017	100%
	Construction/Fit out.	01-10-2017	28-02-2018	10%
	Occupy building.	01-03-2018	30-06-2018	Not started
YTD Actual		YTD Budget	Initiative Budget	
\$ 9,700.00		\$ -	\$664,000	

Initiative Description		Department	Q2 Target	Progress
Continue to support the attraction, placement and recognition of volunteers through the Volunteer Resource Centre for community groups in Knox.		Community Wellbeing	50%	50%
Progress Comment:				
Regular meetings with Volunteer for Knox are being held. Acquittal reports have been completed and funding agreements signed.				
Initiative Milestones	Description	Start date	End date	Progress
	Monitor the service agreement.	01-07-2017	30-06-2018	50%
YTD Actual		YTD Budget	Initiative Budget	
No additional budget, sits within current operating budget.				

Initiative Description		Department	Q2 Target	Progress
Embed a strengthened approach to the management and recognition of volunteers within the organisation.		People Performance	25%	26%
Progress Comment:				
Recruitment of the Volunteer Advisor is now complete with the position to commence on the 15 February 2018.				
Initiative Milestones	Description	Start date	End date	Progress
	Recruitment and induction of a Volunteer Support Advisor.	01-10-2017	30-12-2017	80%
	Establish an internal Volunteer Coordinators network.	01-01-2018	31-03-2018	Not started
	Review current volunteer management practices and processes across Council and prepare a report that identifies strengths, opportunities to improve and a prioritised forward action plan.	01-01-2018	30-06-2018	Not started
YTD Actual		YTD Budget	Initiative Budget	
\$ -		\$26,436.00	\$52,880.00	

Official Minutes of Knox City Council

Goal 8: We have confidence in decision making

Initiative Description	Department	Progress
Review Council's advisory committees to enable community participation, advice and action.	Governance and Innovation	 Complete
Progress Comment:		
A review of Council's Advisory Committees was completed with a Discussion Paper prepared and presented to Councillors at an Issues Briefing meeting held on 14 August 2017. The item was further discussed at an Issues Briefing meeting held on 4 September and 2 October 2017. The Discussion Paper incorporated three models for consideration along with the identification of a number of committees recommended to be retained due to the statutory nature or being a time limited project nature of the committee. Council continues to consider its preferred option and structure of advisory committees.		

Initiative Description	Department	Q2 Target	Progress	
Implement staged delivery of the ICT Roadmap to support organisational efficiency and effectiveness and to increase capacity for customer self-service.	Information Management	50%	37%	
Progress Comment:				
Recruitment for the ICT Governance Committee is now underway with the interview process expected to conclude at the end of January. Further work to identify the benefits associated with the strategy has been completed and is now in review. Work has commenced to progress business cases against three initiatives with the first business case expected to be completed in February.				
Initiative Milestones	Description	Start date	End date	Progress
	Establish Digital/ICT Governance Committee.	01-09-2017	28-02-2018	50%
	Develop Business Cases for approved projects.	01-10-2017	31-04-2018	25%
YTD Actual		YTD Budget	Initiative Budget	
\$21,250		\$30,000	\$220,500	

Initiative Description	Department	Progress		
Strengthen and centralise the coordination, collection and provision of research and data to support future planning by Council.	City Futures	 Complete		
Progress Comment:				
A research and mapping function has been established within the City Futures Department. An annual program of work is under development and key stakeholder partnership building has commenced across the organisation.				
Initiative Milestones	Description	Start date	End date	Progress
	Establishment of Research & Mapping function within City Futures Department.	01-07-2017	30-09-2017	100%
YTD Actual		YTD Budget	Initiative Budget	
\$16,950.00		\$9,950.00	\$15,150	

Initiative Description		Department	Q2 Target	Progress
Finalise and implement Council's Communication Strategy.		Communications and Customer Service	50%	30%
Progress Comment:				
The Communication Strategy is now scheduled for presentation at the March Issues Briefing and the April Council Meeting				
Initiative Milestones	Description	Start date	End date	Progress
	Continue strategy development.	01-07-2017	31-12-2017	40%
	Present report to Executive management and Council for endorsement.	01-01-2018	30-06-2018	20%
YTD Actual		YTD Budget	Initiative Budget	
No additional budget, sits within current operating budget.				

Initiative Description		Department	Q2 Target	Progress
Facilitate regular networking sessions with key agencies and stakeholders to identify partnership opportunities in order to achieve shared Community and Council Plan goals.		City Futures	50%	15%
Progress Comment:				
Planning has commenced for the delivery of a key agency and stakeholder networking session. Sessions are anticipated to occur in early 2018. Detailed scoping is to commence early in 2018, Ongoing engagement with stakeholders will occur in early to mid-2018 and throughout the implementation of the Community and Council Plan 2017-21, including the monitoring and review of the current plan, and to inform the development of the new plan.				
Initiative Milestones	Description	Start date	End date	Progress
	Scope development of regular Networking Session approach.	01-07-2017	30-12-2017	30%
	Develop and commence delivery of a program for key agency & stakeholder networking.	01-01-2018	30-06-2018	Not started
YTD Actual		YTD Budget	Initiative Budget	
No additional budget, sits within current operating budget.				

ALL WARDS**10.2 MINOR GRANTS PROGRAM APPLICATIONS**

SUMMARY: Governance Officer - (Kirstin Ritchie)

This report summarises the recommended grants from the Minor Grants Program. All applications have been assessed against the criteria as set out in the Minor Grants Program Policy.

RECOMMENDATION

That Council:

1. Approve the eight (8) recommended Minor Grants Program applications for a total of \$18,155.00 as detailed below:

Applicant Name	Project Title	Amount Requested	Amount Recommended
Flamingo Community Group	Purchase of a laptop to enable the planning and maintenance of the three year old kinder program.	\$1,298.00	\$1,298.00
Wantirna South Football Club	Purchase of a ground line marking machine for use for match day activities.	\$2,500.00	\$2,500.00
SLAMS Music Theatre Company	Purchase of a headset radio microphone for use in future productions.	\$2,460	\$2,460
Wantirna South Junior Football Club	Purchase of a fryer for the kitchen.	\$3,000	\$3,000
Knox Italian Community Club - Next Generation S.C	Funding to assist with the creation of a website for the community group to raise awareness of the club.	\$1,000	\$1,000
Breakthrough Christian Church Inc	Purchase and installation of artificial grass to create an outdoor community space at the facility	\$3,000	\$3,000
Boronia Soccer Club	Purchase of new uniforms for the club	\$2,000	\$2,000
Wantirna Cricket Club	Purchase of new training equipment, player trophies and a fridge for the club	\$2,897	\$2,897
	TOTAL	\$18,155.00	\$18,155.00

10.2 Minor Grants Program Applications (cont'd)

2. Note the one (1) Minor Grants Program application approved and paid under delegated authority for a total of \$400.00 as detailed below:

Applicant Name	Project Title	Amount Requested	Amount Recommended
Sally Hodgson Ferntree Gully Library Knitting for Charity Group	Money to purchase yarn for the group which will last the next 12 months. All items knitted will be donated to charity organisations.	\$400.00	\$400.00
	TOTAL	\$400.00	\$400.00

3. Note that inclusive of the above grants, a total of \$103,325.38 has been awarded under the Minor Grants Program in 2017-18 in support of a variety of community based organisations and their programs.

1. INTRODUCTION

At the Strategic Planning Committee meeting held on 10 July 2017 the Committee endorsed the Minor Grants Program Policy, effective from 25 July 2017.

Minor Grant applications must be for the purposes of meeting requests for small, incidental funding requests from eligible organisations within Knox and not exceed \$3,000.00.

Under the Minor Grants Program Policy an eligible organisation must:

- provide services, projects and programs that directly benefit residents of the City of Knox;
- be a not for profit legal entity that provides services, support or activities to the Knox community. This expressly excludes educational institutions and State and Federal government departments and agencies; but does not exclude related not for profit organisations, including school councils/auxiliaries/parent groups who otherwise qualify under the Policy;
- be incorporated or be auspiced by an incorporated body (for grants over \$500 only);
- have an Australian Business Number or complete a Statement by Supplier form;

10.2 Minor Grants Program Applications (cont'd)

- have a Committee of Management or similar governing body that accepts responsibility for the administration of the Grant (for grants over \$500 only);
- hold adequate public liability insurance appropriate to the activity outlined in the application;
- be able to supply permits and plans appropriate to the funded activity where requested by Council;
- have provided evidence to Council's satisfaction of the expenditure of any previous grant provided by Council.

This report presents to Council recommended grant applications in accordance with the Minor Grants Program Policy.

2. DISCUSSION

Council established the Minor Grants Program to ensure that funding may be provided to community groups who request ad hoc, incidental, community based, one-off grants.

The Minor Grants Program Policy (the Policy) sets out an open and transparent grant program that meets the principles of good governance and is compliant with the requirements of the *Local Government Act 1989*.

In accordance with the Policy, applications for funding up to \$500 are assessed and determined under delegation by the Chief Executive Officer, or delegate. Applications for funding between \$501 and \$3,000 have been assessed by the Chief Executive Officer, or delegate, for Council's approval.

All recipients of Minor Grants must provide proof of expenditure or purchase. In addition, Minor Grants over \$1,000.00 must meet all funding agreement requirements.

This report outlines the grant applications received since the 26 February 2018 Ordinary Council meeting and recommends eight grants for Council's approval.

3. CONSULTATION

No consultation has been undertaken in relation to the grant applications detailed in this report as the policy specifies assessment can occur by the Chief Executive Officer, or delegate, and make recommendation for Council's determination.

4. ENVIRONMENTAL/AMENITY ISSUES

There are no environmental or amenity issues associated with this report.

10.2 Minor Grants Program Applications (cont'd)

5. FINANCIAL & ECONOMIC IMPLICATIONS

The approval of minor grants is managed within Council's adopted budget.

6. SOCIAL IMPLICATIONS

The Minor Grants program allows Council the flexibility to respond to requests from community groups within Knox at a municipal level. These grants provide applicants the opportunity to participate and support a variety of community based programs.

7. RELEVANCE TO KNOX COMMUNITY AND COUNCIL PLAN 2017-2021

Provision of the Minor Grants program assists Council in meeting the following objectives under the Knox Community and Council Plan.

Goal 6. We are healthy, happy and well

- Strategy 6.2- Support the community to enable positive physical and mental health.

Goal 7. We are inclusive, feel a sense of belonging and value our identity

- Strategy 7.3 - Strengthen community connections.

Goal 8. We have confidence in decision making

- Strategy 8.1 – Build, strengthen and promote good governance practices across government and community organisations.

8. CONFLICT OF INTEREST

Under section 80c of the Local Government Act 1989 officers providing advice to Council must disclose any interests, including the type of interest.

Officer Responsible – Michael Fromberg, Director Corporate Development - In providing this advice as the Officer Responsible, I have no disclosable interests in this report.

Author – Kirstin Ritchie, Governance Officer - In providing this advice as the Author, I have no disclosable interests in this report

8. CONCLUSION

This report contains the recommendation for funding through the Minor Grants program.

10.2 Minor Grants Program Applications (cont'd)**9. CONFIDENTIALITY**

Confidential Appendix A contains each of the individual grant applications for Council's consideration.

COUNCIL RESOLUTION

MOVED: CR. LOCKWOOD

SECONDED: CR. GILL

That Council:

1. Approve the ten (10) recommended Minor Grants Program applications for a total of \$23,384.70 as detailed below:

Applicant Name	Project Title	Amount Requested	Amount Recommended
Flamingo Community Group	Purchase of a laptop to enable the planning and maintenance of the three year old kinder program.	\$1,298.00	\$1,298.00
Wantirna South Football Club	Purchase of a ground line marking machine for use for match day activities.	\$2,500.00	\$2,500.00
SLAMS Music Theatre Company	Purchase of a headset radio microphone for use in future productions.	\$2,460	\$2,460
Wantirna South Junior Football Club	Purchase of a fryer for the kitchen.	\$3,000	\$3,000
Knox Italian Community Club - Next Generation S.C	Funding to assist with the creation of a website for the community group to raise awareness of the club.	\$1,000	\$1,000
Breakthrough Christian Church Inc	Purchase and installation of artificial grass to create an outdoor community space at the facility	\$3,000	\$3,000

10.2 Minor Grants Program Applications (cont'd) Resolution (cont'd)

Applicant Name	Project Title	Amount Requested	Amount Recommended
Boronia Soccer Club	Purchase of new uniforms for the club	\$2,000	\$2,000
Wantirna Cricket Club	Purchase of new training equipment, player trophies and a fridge for the club	\$2,897	\$2,897
1st Bayswater Scout Group	Funding for the purchase of 2 tunnel tents and 6 compasses for the scout group	\$2,229.70	\$2,229.70
Swinburne Volunteer Tutors	Funding towards the publication of a book on the journeys of refugee and new migrant students on their settlement into the Australian community.	\$3,000.00	\$3,000.00
	Total	\$23,384.70	\$23,384.70

2. Note the one (1) Minor Grants Program application approved and paid under delegated authority for a total of \$400.00 as detailed below:

Applicant Name	Project Title	Amount Requested	Amount Recommended
Sally Hodgson Ferntree Gully Library Knitting for Charity Group	Money to purchase yarn for the group which will last the next 12 months. All items knitted will be donated to charity organisations.	\$400.00	\$400.00
	TOTAL	\$400.00	\$400.00

3. Note that inclusive of the above grants, a total of \$108,555.08 has been awarded under the Minor Grants Program in 2017-18 in support of a variety of community based organisations and their programs.

CARRIED

10.2 Minor Grants Program Applications

Confidential Appendix A is circulated under separate cover.

Official Minutes of Knox City Council

ALL WARDS**10.3 REVISED INSTRUMENTS OF DELEGATION TO MEMBERS OF COUNCIL STAFF**

SUMMARY: *Director – Corporate Services (Michael Fromberg)*

Instruments of Delegation represent the formal delegation of powers by Council under Section 98(1) of the Local Government Act 1989 and enable the effective functioning of Council.

The attached Instruments of Delegations (Instruments) have been revised to reflect an organisation restructure of the Corporate Services Directorate, previously Corporate Development, of Council and to reflect minor legislative changes.

RECOMMENDATION

In the exercise of the powers conferred by section 98(1) of the Local Government Act 1989 (the act) and the other legislation referred to in the attached Instrument of Delegation – Cemeteries and Crematoria (Appendix A), Instrument of Delegation – Domestic Animals, Environmental Protection and Food (Appendix B) and Instrument of Delegation - Road Management Responsibilities (Appendix C), Knox City Council (Council) resolves that -

1. There be delegated to the members of Council staff holding, acting or performing the duties of the offices or positions referred to in the attached:
 - Instrument of Delegation – Cemeteries and Crematoria (Appendix A),
 - Instrument of Delegation – Domestic Animals, Environmental Protection and Food (Appendix B) and
 - Instrument of Delegation - Road Management Responsibilities (Appendix C),

the powers, duties and functions set out in that respective instrument, subject to the conditions and limitations specified in the instrument;
2. Each Instrument of Delegation in Resolution 1 above comes into force immediately the common seal of Council is affixed to the instrument;
3. On the coming into force of each instrument set out in Resolution 1 above the respective previous Instrument of Delegation be revoked; and
4. The duties and functions set out in each instrument in Resolution 1 above must be executed, in accordance with any guidelines or policies of Council that it may from time to time adopt

10.3 Revised Instruments of Delegation to Members of Council Staff (cont'd)

1. INTRODUCTION

Section 98 of the *Local Government Act 1989* empowers Council to delegate any of its powers, duties or functions with some strategic exemptions such as setting rates, borrowing funds and adopting a budget. It is widely accepted that delegations are necessary to facilitate effective functioning of Councils as they enable day-to-day decisions to be made in relation to routine administrative and operational matters.

In granting delegations, Council is not granting unfettered power to Council staff or relinquishing its own powers. A delegate must comply with the conditions of delegation as well as any policies of Council and any legislative framework. Further, Council can still exercise any delegated power, duty or functions itself by resolution in the Chamber.

The attached Instruments are recommended for the effective and efficient operations of Council's activities, as well as to enable routine and administrative tasks to be carried out with consistency and certainty.

2. DISCUSSION

The attached Instruments are being refreshed to ensure that they remain contemporaneous and consistent with current legislation and business practices.

The current Instrument of Delegation – Cemeteries and Crematoria has been in force since 25 September 2017.

The current Instrument of Delegation – Domestic Animals, Environmental Protection and Food Act has been in force since 24 July 2017.

The current Instrument of Delegation – Road Management Responsibilities has been in force since 24 July 2017.

The attached Instruments are based upon the previous Instruments considered by Council and have been revised to reflect recent legislative changes and an organisational restructure of the Corporate Services directorate of Council.

10.3 Revised Instruments of Delegation to Members of Council Staff (cont'd)

The key elements of the corporate restructure are as follows:

Current Instrument	Revised Instrument
Director – Corporate Development	Director – Corporate Services
Manager – Information Management	Manager – Information Technology
Manager – Communications and Customer Service	Manager – Transformation
	Manager – Communications
Manager – Governance & Innovation	Manager – Governance & Strategy
Manager – Financial Services	Manager – Business & Financial Services

All changes are minor in nature and have been highlighted using tracked changes in appendix A, B and C.

3. CONSULTATION

Council subscribes to the Maddocks Authorisations and Delegations Service, which provides advice regarding legislative amendments and template instruments, which are then tailored to organisational requirements. The proposed instruments (Attachment A, B and C) have been prepared based on the advice provided by Maddocks Lawyers.

Consultation has occurred with relevant staff during the preparation of the revised Instrument of Delegation to ensure that appropriate staff delegates have been nominated.

4. ENVIRONMENTAL/AMENITY ISSUES

Changes to the attached Instruments will not have any additional effect on the environmental or amenity issues within Knox beyond normal work practices.

5. FINANCIAL & ECONOMIC IMPLICATIONS

The costs to prepare and adopt the attached Instruments are minimal and will be met within the current departmental budget.

6. SOCIAL IMPLICATIONS

There will be no additional social implications.

10.3 Revised Instruments of Delegation to Members of Council Staff (cont'd)

7. RELEVANCE TO KNOX COMMUNITY AND COUNCIL PLAN 2017-2021

The adoption of Instruments of Delegation assists Council in meeting the following objectives under the Knox Community and Council Plan.

Goal 8. We have confidence in decision making

Strategy 8.1 – Build, strengthen and promote good governance practices across government and community organisation.

8. CONFLICT OF INTEREST

Under section 80c of the Local Government Act 1989 officers providing advice to Council must disclose any interests, including the type of interest.

Officer Responsible – Michael Fromberg, Director Corporate Development - In providing this advice as the Officer Responsible, I have no disclosable interests in this report.

Author – Kirstin Ritchie, Governance Officer - In providing this advice as the Author, I have no disclosable interests in this report

9. CONCLUSION

The form and content of the attached revised Instruments are consistent with the Instruments previously adopted by Council and enable the effective functioning of Knox City Council. It is therefore recommended that Council sign and seal the revised attached Instruments (Attachment A, B and C).

10. CONFIDENTIALITY

There are no items of a confidential nature in this report.

10.3 Revised Instruments of Delegation to Members of Council Staff (cont'd)**COUNCIL RESOLUTION****MOVED: CR. PEARCE****SECONDED: CR. GILL**

In the exercise of the powers conferred by section 98(1) of the Local Government Act 1989 (the act) and the other legislation referred to in the attached Instrument of Delegation – Cemeteries and Crematoria (Appendix A), Instrument of Delegation – Domestic Animals, Environmental Protection and Food (Appendix B) and Instrument of Delegation - Road Management Responsibilities (Appendix C), Knox City Council (Council) resolves that -

1. There be delegated to the members of Council staff holding, acting or performing the duties of the offices or positions referred to in the attached:

- Instrument of Delegation – Cemeteries and Crematoria (Appendix A),
- Instrument of Delegation – Domestic Animals, Environmental Protection and Food (Appendix B) and
- Instrument of Delegation - Road Management Responsibilities (Appendix C),

the powers, duties and functions set out in that respective instrument, subject to the conditions and limitations specified in the instrument;

2. Each Instrument of Delegation in Resolution 1 above comes into force immediately the common seal of Council is affixed to the instrument;

3. On the coming into force of each instrument set out in Resolution 1 above the respective previous Instrument of Delegation be revoked; and

4. The duties and functions set out in each instrument in Resolution 1 above must be executed, in accordance with any guidelines or policies of Council that it may from time to time adopt

CARRIED



INSTRUMENT OF DELEGATION COUNCIL TO

COUNCIL STAFF – CEMETERIES & CREMATORIA

In exercise of the power conferred by section 98(1) and 86(3) of the *Local Government Act* 1989 and the other legislation referred to in the attached Schedule, the Council:

1. delegates each duty and/or function and/or power described in column 1 of the Schedule (and summarised in column 2 of the Schedule) to the member of Council staff holding, acting in or performing the duties of the office or position described opposite each such duty and/or function and/or power in column 3 of the Schedule;
2. declares that:
 - 2.1 this Instrument of Delegation is authorised by a resolution of Council passed on 25 September 2017; and
 - 2.2 the delegation:
 - 2.2.1 comes into force immediately the common seal of Council is affixed to this Instrument of Delegation;
 - 2.2.2 remains in force until varied or revoked;
 - 2.2.3 is subject to any conditions and limitations set out in sub-paragraph 3.3, and the Schedule; and
 - 2.2.4 must be exercised in accordance with any guidelines or policies which Council from time to time adopts; and
 - 2.3 the delegate must not determine the issue, take the action or do the act or thing:
 - 2.3.1 if the issue, action, act or thing is an issue, action or thing which Council has previously designated as an issue, action, act or thing which must be the subject of a Resolution of Council; or
 - 2.3.2 if the determining of the issue, taking of the action or doing of the act or thing would or would be likely to involve a decision which is inconsistent with a
 - (a) policy; or
 - (b) strategy
 adopted by Council; or

2.3.3 if the determining of the issue, the taking of the action or the doing of the act or thing cannot be the subject of a lawful delegation, whether on account of section 98(1)(a)-(f) (inclusive) of the Act or otherwise; or

2.3.4 the determining of the issue, the taking of the action or the doing of the act or thing is already the subject of an exclusive delegation to another member of Council staff.

3. In exercising any duty, function or power under this delegation the officer concerned will be mindful of the provisions under Division 1A – Conduct and Interests of the Local Government Act 1989.

3.1 The principles of these provisions will apply to delegated officers.

3.2 Any disclosures under section 77A or 79 must be recorded in accordance with any guidelines or policies which Council from time to time adopts.

THE COMMON SEAL of KNOX CITY COUNCIL

was affixed pursuant to an Order of the Council made on the 27 March 2018 in the presence of

Mayor

Chief Executive Officer

Councillor

SCHEDULE

Official Minutes of Knox City Council



INDEX

CEMETERIES AND CREMATORIA ACT 2003.....1
CEMETERIES AND CREMATORIA REGULATIONS 2015 28

Official Minutes of Knox City Council

CEMETERIES AND CREMATORIA ACT 2003

The provisions of this Act apply to Councils appointed as a cemetery trust under section 5 of this Act, and also apply to Councils appointed to manage a public cemetery under section 8(1)(a)(ii) as though it were a cemetery trust (see section 53)

Column 1	Column 2	Column 3	Column 4
PROVISION	THING DELEGATED	DELEGATE	CONDITIONS & LIMITATIONS
s.8(1)(a)(ii)	power to manage one or more public cemeteries	Not Delegated	•
s.12(1)	function to properly and efficiently manage and maintain each public cemetery for which responsible and carry out any other function conferred under this Act	Chief Executive Officer Director - Corporate Development Director - Corporate Services Manager - Governance & Innovation Manager - Governance & Strategy Coordinator - Governance	where council is a Class B cemetery trust
s.12(2)	duty to have regard to the matters set out in paragraphs (a)-(c) in exercising its functions	Chief Executive Officer Director - Corporate Development Director - Corporate Services Manager - Governance & Innovation Manager - Governance & Strategy Coordinator - Governance	where council is a Class B cemetery trust
s.13	duty to do anything necessary or convenient to enable it to carry out its functions	Chief Executive Officer Director - Corporate Development Director - Corporate Services Manager - Governance & Innovation Manager - Governance & Strategy Coordinator - Governance Senior Administration Officer Administration Officer Sexton	
s.15(1) and (2)	power to delegate powers or functions other than those listed	Chief Executive Officer	

CEMETERIES AND CREMATORIA ACT 2003			
### The provisions of this Act apply to Councils appointed as a cemetery trust under section 5 of this Act, and also apply to Councils appointed to manage a public cemetery under section 8(1)(a)(ii) as though it were a cemetery trust (see section 53)			
Column 1	Column 2	Column 3	Column 4
PROVISION	THING DELEGATED	DELEGATE	CONDITIONS & LIMITATIONS
s.15(4)	duty to keep records of delegations	Chief Executive Officer Director - Corporate Development Director - Corporate Services Manager - Governance & Innovation Manager - Governance & Strategy Coordinator - Governance Governance Officer	
s.17(1)	power to employ any persons necessary	Chief Executive Officer Director - Corporate Development Director - Corporate Services Manager - People Performance Coordinator - Employee Relations & Pay Manager - Governance & Innovation Manager - Governance & Strategy Coordinator - Governance	
s.17(2)	power to engage any professional, technical or other assistance considered necessary	Chief Executive Officer Director - Corporate Development Director - Corporate Services Manager - Governance & Innovation Manager - Governance & Strategy Coordinator - Governance	

CEMETERIES AND CREMATORIA ACT 2003			
### The provisions of this Act apply to Councils appointed as a cemetery trust under section 5 of this Act, and also apply to Councils appointed to manage a public cemetery under section 8(1)(a)(ii) as though it were a cemetery trust (see section 53)			
Column 1	Column 2	Column 3	Column 4
PROVISION	THING DELEGATED	DELEGATE	CONDITIONS & LIMITATIONS
s. 17(3)	power to determine the terms and conditions of employment or engagement	Chief Executive Officer Director - Corporate Development Director - Corporate Services Manager - Governance & Innovation Manager - Governance & Strategy Coordinator - Governance	subject to any guidelines or directions of the Secretary
s.18(3)	duty to comply with a direction from the Secretary	Chief Executive Officer Director - Corporate Development Director - Corporate Services Manager - Governance & Innovation Manager - Governance & Strategy Coordinator - Governance	
s.19	power to carry out or permit the carrying out of works	Chief Executive Officer Director - Corporate Development Director - Corporate Services Manager - Governance & Innovation Manager - Governance & Strategy Coordinator - Governance Senior Admin Support Officer Sexton	

CEMETERIES AND CREMATORIA ACT 2003			
### The provisions of this Act apply to Councils appointed as a cemetery trust under section 5 of this Act, and also apply to Councils appointed to manage a public cemetery under section 8(1)(a)(ii) as though it were a cemetery trust (see section 53)			
Column 1	Column 2	Column 3	Column 4
PROVISION	THING DELEGATED	DELEGATE	CONDITIONS & LIMITATIONS
s.20(1)	duty to set aside areas for the interment of human remains	Chief Executive Officer Director - Corporate Development Director - Corporate Services Manager - Governance & Innovation Manager - Governance & Strategy	
s.20(2)	power to set aside areas for the purposes of managing a public cemetery	Chief Executive Officer Director - Corporate Development Director - Corporate Services Manager - Governance & Innovation Manager - Governance & Strategy	
s.20(3)	power to set aside areas for those things in paragraphs (a) – (e)	Chief Executive Officer Director - Corporate Development Director - Corporate Services Manager - Governance & Innovation Manager - Governance & Strategy	
s.24(2)	power to apply to the Secretary for approval to alter the existing distribution of land	Chief Executive Officer Director - Corporate Development Director - Corporate Services Manager - Governance & Innovation Manager - Governance & Strategy	

CEMETERIES AND CREMATORIA ACT 2003			
### The provisions of this Act apply to Councils appointed as a cemetery trust under section 5 of this Act, and also apply to Councils appointed to manage a public cemetery under section 8(1)(a)(ii) as though it were a cemetery trust (see section 53)			
Column 1	Column 2	Column 3	Column 4
PROVISION	THING DELEGATED	DELEGATE	CONDITIONS & LIMITATIONS
s.36	power to grant licences to enter and use part of the land or building in a public cemetery in accordance with this section	Chief Executive Officer Director - Corporate Development Director - Corporate Services Manager - Governance & Innovation Manager - Governance & Strategy	subject to the approval of the Minister
s.37	power to grant leases over land in a public cemetery in accordance with this section	Not Delegated	subject to the Minister approving the purpose
s.40	duty to notify Secretary of fees and charges fixed under section 39	Chief Executive Officer Director - Corporate Development Director - Corporate Services Manager - Governance & Innovation Manager - Governance & Strategy Coordinator - Governance	
s.57(1)	duty to submit a report to the Secretary every financial year in respect of powers and functions under the Act	Chief Executive Officer Director - Corporate Development Director - Corporate Services Manager - Governance & Innovation Manager - Governance & Strategy Coordinator - Governance Senior Administrative Officer Administrative Officer	report must contain the particulars listed in s.57(2) report must be endorsed by Council

CEMETERIES AND CREMATORIA ACT 2003			
### The provisions of this Act apply to Councils appointed as a cemetery trust under section 5 of this Act, and also apply to Councils appointed to manage a public cemetery under section 8(1)(a)(ii) as though it were a cemetery trust (see section 53)			
Column 1	Column 2	Column 3	Column 4
PROVISION	THING DELEGATED	DELEGATE	CONDITIONS & LIMITATIONS
s.59	duty to keep records for each public cemetery	Chief Executive Officer Director - Corporate Development Director - Corporate Services Manager - Governance & Innovation Manager - Governance & Strategy Coordinator - Governance Senior Administrative Officer Administrative Officer	
s.60(1)	duty to make information in records available to the public for historical or research purposes	Chief Executive Officer Director - Corporate Development Director - Corporate Services Manager - Governance & Innovation Manager - Governance & Strategy Coordinator - Governance Senior Administrative Officer Administrative Officer	
s.60(2)	power to charge fees for providing information	Chief Executive Officer	
s.64B(d)	power to permit interments at a reopened cemetery	Chief Executive Officer Director - Corporate Development Director - Corporate Services Manager - Governance & Innovation Manager - Governance & Strategy Coordinator - Governance Senior Administrative Officer Administrative Officer	

CEMETERIES AND CREMATORIA ACT 2003			
### The provisions of this Act apply to Councils appointed as a cemetery trust under section 5 of this Act, and also apply to Councils appointed to manage a public cemetery under section 8(1)(a)(ii) as though it were a cemetery trust (see section 53)			
Column 1	Column 2	Column 3	Column 4
PROVISION	THING DELEGATED	DELEGATE	CONDITIONS & LIMITATIONS
s.66(1)	power to apply to the Minister for approval to convert the cemetery, or part of it, to a historic cemetery park	Chief Executive Officer	the application must include the requirements listed in s.66(2)(a)–(d)
s.69	duty to take reasonable steps to notify of conversion to historic cemetery park	Chief Executive Officer Director – Corporate Development Director - Corporate Services Manager – Governance & Innovation Manager - Governance & Strategy Coordinator - Governance Senior Administrative Officer	
s.70(1)	duty to prepare plan of existing places of interment and make a record of any inscriptions on memorials which are to be removed	Chief Executive Officer Director – Corporate Development Director - Corporate Services Manager – Governance & Innovation Manager - Governance & Strategy Coordinator - Governance	
s.70(2)	duty to make plans of existing place of interment available to the public	Chief Executive Officer Director – Corporate Development Director - Corporate Services Manager – Governance & Innovation Manager - Governance & Strategy Coordinator - Governance	

CEMETERIES AND CREMATORIA ACT 2003			
### The provisions of this Act apply to Councils appointed as a cemetery trust under section 5 of this Act, and also apply to Councils appointed to manage a public cemetery under section 8(1)(a)(ii) as though it were a cemetery trust (see section 53)			
Column 1	Column 2	Column 3	Column 4
PROVISION	THING DELEGATED	DELEGATE	CONDITIONS & LIMITATIONS
s.71(1)	power to remove any memorials or other structures in an area to which an approval to convert applies	Chief Executive Officer Director - Corporate Development Director - Corporate Services Manager - Governance & Innovation Manager - Governance & Strategy Coordinator - Governance Sexton	
s.71(2)	power to dispose of any memorial or other structure removed	Chief Executive Officer Director - Corporate Development Director - Corporate Services Manager - Governance & Innovation Manager - Governance & Strategy Coordinator - Governance Sexton	
s.72(2)	duty to comply with request received under section 72	Chief Executive Officer Director - Corporate Development Director - Corporate Services Manager - Governance & Innovation Manager - Governance & Strategy Coordinator - Governance Senior Administrative Officer	

CEMETERIES AND CREMATORIA ACT 2003			
### The provisions of this Act apply to Councils appointed as a cemetery trust under section 5 of this Act, and also apply to Councils appointed to manage a public cemetery under section 8(1)(a)(ii) as though it were a cemetery trust (see section 53)			
Column 1	Column 2	Column 3	Column 4
PROVISION	THING DELEGATED	DELEGATE	CONDITIONS & LIMITATIONS
s.73(1)	power to grant a right of interment	Chief Executive Officer Director - Corporate Development Director - Corporate Services Manager - Governance & Innovation Manager - Governance & Strategy Coordinator - Governance Senior Administrative Officer Administrative Officer	
s.73(2)	power to impose conditions on the right of interment	Chief Executive Officer Director - Corporate Development Director - Corporate Services Manager - Governance & Innovation Manager - Governance & Strategy Coordinator - Governance Senior Administrative Officer Administrative Officer	
s.75	power to grant the rights of interment set out in subsections (a) and (b)	Chief Executive Officer Director - Corporate Development Director - Corporate Services Manager - Governance & Innovation Manager - Governance & Strategy Coordinator - Governance Senior Administrative Officer Administrative Officer	

CEMETERIES AND CREMATORIA ACT 2003			
### The provisions of this Act apply to Councils appointed as a cemetery trust under section 5 of this Act, and also apply to Councils appointed to manage a public cemetery under section 8(1)(a)(ii) as though it were a cemetery trust (see section 53)			
Column 1	Column 2	Column 3	Column 4
PROVISION	THING DELEGATED	DELEGATE	CONDITIONS & LIMITATIONS
s.76(3)	duty to allocate a piece of interment if an unallocated right is granted	Chief Executive Officer Director - Corporate Development Director - Corporate Services Manager - Governance & Innovation Manager - Governance & Strategy Coordinator - Governance Senior Administrative Officer Administrative Officer	
s.77(4)	power to authorise and impose terms and conditions on the removal of cremated human remains or body parts from the place of interment on application	Chief Executive Officer Director - Corporate Development Director - Corporate Services Manager - Governance & Innovation Manager - Governance & Strategy Coordinator - Governance Senior Administrative Officer Administrative Officer	
s.80(1)	function of receiving notification and payment of transfer of right of interment	Chief Executive Officer Director - Corporate Development Director - Corporate Services Manager - Governance & Innovation Manager - Governance & Strategy Coordinator - Governance Senior Administrative Officer Administrative Officer	

CEMETERIES AND CREMATORIA ACT 2003			
### The provisions of this Act apply to Councils appointed as a cemetery trust under section 5 of this Act, and also apply to Councils appointed to manage a public cemetery under section 8(1)(a)(ii) as though it were a cemetery trust (see section 53)			
Column 1	Column 2	Column 3	Column 4
PROVISION	THING DELEGATED	DELEGATE	CONDITIONS & LIMITATIONS
s.80(2)	function of recording transfer of right of interment	Chief Executive Officer Director – Corporate Development Director - Corporate Services Manager – Governance & Innovation Manager - Governance & Strategy Coordinator - Governance Senior Administrative Officer Administrative Officer	
s.82(2)	duty to pay refund on the surrender of an unexercised right of interment	Chief Executive Officer Director – Corporate Development Director - Corporate Services Manager – Governance & Innovation Manager - Governance & Strategy Coordinator – Governance Senior Administrative Officer	
s.83(2)	duty to pay refund on the surrender of an unexercised right of interment (sole holder)	Chief Executive Officer Director – Corporate Development Director - Corporate Services Manager – Governance & Innovation Manager - Governance & Strategy Coordinator - Governance Senior Administrative Officer	

CEMETERIES AND CREMATORIA ACT 2003			
### The provisions of this Act apply to Councils appointed as a cemetery trust under section 5 of this Act, and also apply to Councils appointed to manage a public cemetery under section 8(1)(a)(ii) as though it were a cemetery trust (see section 53)			
Column 1	Column 2	Column 3	Column 4
PROVISION	THING DELEGATED	DELEGATE	CONDITIONS & LIMITATIONS
s.83(3)	power to remove any memorial and grant another right of interment for a surrendered right of interment	Chief Executive Officer Director - Corporate Development Director - Corporate Services Manager - Governance & Innovation Manager - Governance & Strategy Coordinator - Governance Senior Administrative Officer	
s.84(1)	function of receiving notice of surrendering an entitlement to a right of interment	Chief Executive Officer Director - Corporate Development Director - Corporate Services Manager - Governance & Innovation Manager - Governance & Strategy Coordinator - Governance Senior Administrative Officer Administrative Officer	
s.85(1)	duty to notify holder of 25 year right of interment of expiration at least 12 months before expiry	Chief Executive Officer Director - Corporate Development Director - Corporate Services Manager - Governance & Innovation Manager - Governance & Strategy Coordinator - Governance Senior Administrative Officer Administration Officer	the notice must be in writing and contain the requirements listed in s.85(2)

CEMETERIES AND CREMATORIA ACT 2003			
### The provisions of this Act apply to Councils appointed as a cemetery trust under section 5 of this Act, and also apply to Councils appointed to manage a public cemetery under section 8(1)(a)(ii) as though it were a cemetery trust (see section 53)			
Column 1	Column 2	Column 3	Column 4
PROVISION	THING DELEGATED	DELEGATE	CONDITIONS & LIMITATIONS
s.85(2)(b)	duty to notify holder of 25 year right of interment of expiration of right at least 12 months before expiry	Chief Executive Officer Director - Corporate Development Director - Corporate Services Manager - Governance & Innovation Manager - Governance & Strategy Coordinator - Governance Senior Administrative Officer Administrative Officer	does not apply where right of interment relates to remains of a deceased veteran.
85(2)(c)	power to leave interred cremated remains undistributed in perpetuity and convert right of interment to perpetual right of interment or; remove interred remains and re-inter at another location within cemetery grounds and remove any memorial at that place and re-establish at new or equivalent location.	Chief Executive Officer Director - Corporate Development Director - Corporate Services Manager - Governance & Innovation Manager - Governance & Strategy Coordinator - Governance	may only be exercised where right of interment relates to cremated human remains of a deceased identified veteran, if right of interment is not extended or converted to a perpetual right of interment
s.86	power to remove and dispose of cremated human remains and remove any memorial if no action taken by right holder within time specified	Chief Executive Officer Director - Corporate Development Director - Corporate Services Manager - Governance & Innovation Manager - Governance & Strategy Coordinator - Governance Sexton	

CEMETERIES AND CREMATORIA ACT 2003			
### The provisions of this Act apply to Councils appointed as a cemetery trust under section 5 of this Act, and also apply to Councils appointed to manage a public cemetery under section 8(1)(a)(ii) as though it were a cemetery trust (see section 53)			
Column 1	Column 2	Column 3	Column 4
PROVISION	THING DELEGATED	DELEGATE	CONDITIONS & LIMITATIONS
s.86(2)	power to leave interred cremated human remains undisturbed or convert the right of interment to a perpetual right of interment	Chief Executive Officer Director - Corporate Development Director - Corporate Services Manager - Governance & Innovation Manager - Governance & Strategy Coordinator - Governance	
s.86(3)(a)	power to leave interred cremated human remains undisturbed in perpetuity and convert the right of interment to a perpetual right of interment	Chief Executive Officer Director - Corporate Development Director - Corporate Services Manager - Governance & Innovation Manager - Governance & Strategy Coordinator - Governance	
s.86(3)(b)	power to remove interred cremated human remains and take further action in accordance with s.86(3)(b)	Chief Executive Officer Director - Corporate Development Director - Corporate Services Manager - Governance & Innovation Manager - Governance & Strategy Coordinator - Governance	

CEMETERIES AND CREMATORIA ACT 2003			
### The provisions of this Act apply to Councils appointed as a cemetery trust under section 5 of this Act, and also apply to Councils appointed to manage a public cemetery under section 8(1)(a)(ii) as though it were a cemetery trust (see section 53)			
Column 1	Column 2	Column 3	Column 4
PROVISION	THING DELEGATED	DELEGATE	CONDITIONS & LIMITATIONS
s.86(4)	power to take action under s.86(4) relating to removing and re-interring cremated human remains	Chief Executive Officer Director - Corporate Development Director - Corporate Services Manager - Governance & Innovation Manager - Governance & Strategy Coordinator - Governance Senior Administrative Officer	
s.86(5)	duty to provide notification before taking action under s.86(4)	Chief Executive Officer Director - Corporate Development Director - Corporate Services Manager - Governance & Innovation Manager - Governance & Strategy Coordinator - Governance Senior Administrative Officer	
s 86A	duty to maintain place of interment and any memorial at place of interment, if action taken under s.86(3)	Chief Executive Officer Director - Corporate Development Director - Corporate Services Manager - Governance & Innovation Manager - Governance & Strategy Coordinator - Governance Senior Administrative Officer	

CEMETERIES AND CREMATORIA ACT 2003			
### The provisions of this Act apply to Councils appointed as a cemetery trust under section 5 of this Act, and also apply to Councils appointed to manage a public cemetery under section 8(1)(a)(ii) as though it were a cemetery trust (see section 53)			
Column 1	Column 2	Column 3	Column 4
PROVISION	THING DELEGATED	DELEGATE	CONDITIONS & LIMITATIONS
s.87(3)	duty, if requested, to extend the right for a further 25 years or convert the right to a perpetual right of interment	Chief Executive Officer Director – Corporate Development Director - Corporate Services Manager – Governance & Innovation Manager - Governance & Strategy Coordinator - Governance Senior Administrative Officer Administrative Officer	
s.88	function to receive applications to carry out a lift and re-position procedure at a place of interment	Chief Executive Officer Director – Corporate Development Director - Corporate Services Manager – Governance & Innovation Manager - Governance & Strategy Coordinator - Governance	
s.91(1)	power to cancel a right of interment in accordance with this section	Not Delegated	
s.91(3)	duty to publish notice of intention to cancel right of interment	Chief Executive Officer Director – Corporate Development Director - Corporate Services Manager – Governance & Innovation Manager - Governance & Strategy Coordinator - Governance	

CEMETERIES AND CREMATORIA ACT 2003			
### The provisions of this Act apply to Councils appointed as a cemetery trust under section 5 of this Act, and also apply to Councils appointed to manage a public cemetery under section 8(1)(a)(ii) as though it were a cemetery trust (see section 53)			
Column 1	Column 2	Column 3	Column 4
PROVISION	THING DELEGATED	DELEGATE	CONDITIONS & LIMITATIONS
s.92	power to pay refund or grant a right of interment in respect of another place of interment to the previous holder of the cancelled right of interment	Chief Executive Officer Director - Corporate Development Director - Corporate Services Manager - Governance & Innovation Manager - Governance & Strategy Coordinator - Governance	
s.98(1)	function of receiving application to establish or alter a memorial or a place of interment	Chief Executive Officer Director - Corporate Development Director - Corporate Services Manager - Governance & Innovation Manager - Governance & Strategy Coordinator - Governance Senior Administrative Officer Administrative Officer	
s.99	power to approve or refuse an application made under section 98, or to cancel an approval	Chief Executive Officer Director - Corporate Development Director - Corporate Services Manager - Governance & Innovation Manager - Governance & Strategy Coordinator - Governance Senior Administrative Officer Administrative Officer	Advice should be sought from the Sexton as required before exercising this power

CEMETERIES AND CREMATORIA ACT 2003			
### The provisions of this Act apply to Councils appointed as a cemetery trust under section 5 of this Act, and also apply to Councils appointed to manage a public cemetery under section 8(1)(a)(ii) as though it were a cemetery trust (see section 53)			
Column 1	Column 2	Column 3	Column 4
PROVISION	THING DELEGATED	DELEGATE	CONDITIONS & LIMITATIONS
s.99(4)	duty to make a decision on an application under section 98 within 45 days after receipt of the application or within 45 days of receiving further information where requested	Chief Executive Officer Director – Corporate Development Director - Corporate Services Manager – Governance & Innovation Manager - Governance & Strategy Coordinator - Governance Senior Administrative Officer Administrative Officer	Advice should be sought from the Sexton as required before exercising this power
s.100(1)	power to require a person to remove memorials or places of interment	Chief Executive Officer Director – Corporate Development Director - Corporate Services Manager – Governance & Innovation Manager - Governance & Strategy Coordinator - Governance	
s.100(2)	power to remove and dispose a memorial or place of interment or remedy a person's failure to comply with section 100(1)	Chief Executive Officer Director – Corporate Development Director - Corporate Services Manager – Governance & Innovation Manager - Governance & Strategy Coordinator - Governance Sexton	

CEMETERIES AND CREMATORIA ACT 2003			
### The provisions of this Act apply to Councils appointed as a cemetery trust under section 5 of this Act, and also apply to Councils appointed to manage a public cemetery under section 8(1)(a)(ii) as though it were a cemetery trust (see section 53)			
Column 1	Column 2	Column 3	Column 4
PROVISION	THING DELEGATED	DELEGATE	CONDITIONS & LIMITATIONS
s.100(3)	power to recover costs of taking action under section 100(2)	Chief Executive Officer Director - Corporate Development Director - Corporate Services Manager - Governance & Innovation Manager - Governance & Strategy Coordinator - Governance	
s.101	Function of receiving applications to establish or alter a building for ceremonies in the cemetery	Chief Executive Officer Director - Corporate Development Director - Corporate Services Manager - Governance & Innovation Manager - Governance & Strategy Coordinator - Governance	
s.102(1)	Power to approve or refuse an application under section 101, if satisfied of the matters in (b) and (c)	Not Delegated	
s.102(2) & (3)	Power to set terms and conditions in respect of, or to cancel, an approval granted under section 102(1)	Not Delegated	
s.103(1)	power to require a person to remove a building for ceremonies	Not Delegated	
s.103(2)	power to remove and dispose of a building for ceremonies or remedy the failure to comply with section 103(1)	Chief Executive Officer Director - Corporate Development Director - Corporate Services Manager - Governance & Innovation Manager - Governance & Strategy	

CEMETERIES AND CREMATORIA ACT 2003			
### The provisions of this Act apply to Councils appointed as a cemetery trust under section 5 of this Act, and also apply to Councils appointed to manage a public cemetery under section 8(1)(a)(ii) as though it were a cemetery trust (see section 53)			
Column 1	Column 2	Column 3	Column 4
PROVISION	THING DELEGATED	DELEGATE	CONDITIONS & LIMITATIONS
s.103(3)	power to recover costs of taking action under section 103(2)	Chief Executive Officer Director – Corporate Development Director - Corporate Services Manager – Governance & Innovation Manager - Governance & Strategy	
s.106(1)	power to require the holder of the right of interment of the requirement to make the memorial or place of interment safe and proper or carry out specified repairs	Chief Executive Officer Director – Corporate Development Director - Corporate Services Manager – Governance & Innovation Manager - Governance & Strategy Coordinator - Governance	
s.106(2)	power to require the holder of the right of interment to provide for an examination	Chief Executive Officer Director – Corporate Development Director - Corporate Services Manager – Governance & Innovation Manager - Governance & Strategy Coordinator - Governance	In consultation with Council

CEMETERIES AND CREMATORIA ACT 2003			
### The provisions of this Act apply to Councils appointed as a cemetery trust under section 5 of this Act, and also apply to Councils appointed to manage a public cemetery under section 8(1)(a)(ii) as though it were a cemetery trust (see section 53)			
Column 1	Column 2	Column 3	Column 4
PROVISION	THING DELEGATED	DELEGATE	CONDITIONS & LIMITATIONS
s.106(3)	power to open and examine the place of interment if section 106(2) not complied with	Chief Executive Officer Director – Corporate Development Director - Corporate Services Manager – Governance & Innovation Manager - Governance & Strategy Coordinator – Governance Sexton	In consultation with Council
s.106(4)	power to repair or – with the approval of the Secretary - take down, remove and dispose any memorial or place of interment if notice under section 106(1) is not complied with	Chief Executive Officer Director – Corporate Development Director - Corporate Services Manager – Governance & Innovation Manager - Governance & Strategy Coordinator – Governance Sexton	In consultation with, Council
s.107(1)	power to require person responsible to make the building for ceremonies safe and proper or carry out specified repairs	Chief Executive Officer Director – Corporate Development Director - Corporate Services Manager – Governance & Innovation Manager - Governance & Strategy	In consultation with Council

CEMETERIES AND CREMATORIA ACT 2003			
### The provisions of this Act apply to Councils appointed as a cemetery trust under section 5 of this Act, and also apply to Councils appointed to manage a public cemetery under section 8(1)(a)(ii) as though it were a cemetery trust (see section 53)			
Column 1	Column 2	Column 3	Column 4
PROVISION	THING DELEGATED	DELEGATE	CONDITIONS & LIMITATIONS
s.107(2)	power to repair or take down, remove and dispose any building for ceremonies if notice under section 107(1) is not complied with	Chief Executive Officer Director - Corporate Development Director - Corporate Services Manager - Governance & Innovation Manager - Governance & Strategy	In consultation with Council
s.108	power to recover costs and expenses	Chief Executive Officer Director - Corporate Development Director - Corporate Services Manager - Governance & Innovation Manager - Governance & Strategy Coordinator - Governance	In consultation with Council
s.109(1)(a)	power to open, examine and repair a place of interment	Chief Executive Officer Director - Corporate Development Director - Corporate Services Manager - Governance & Innovation Manager - Governance & Strategy Coordinator - Governance Sexton	where the holder of right of interment or responsible person cannot be found In consultation with Council

CEMETERIES AND CREMATORIA ACT 2003			
### The provisions of this Act apply to Councils appointed as a cemetery trust under section 5 of this Act, and also apply to Councils appointed to manage a public cemetery under section 8(1)(a)(ii) as though it were a cemetery trust (see section 53)			
Column 1	Column 2	Column 3	Column 4
PROVISION	THING DELEGATED	DELEGATE	CONDITIONS & LIMITATIONS
s.109(1)(b)	power to repair a memorial or, with the Secretary's consent, take down, remove and dispose of a memorial	Chief Executive Officer Director – Corporate Development Director - Corporate Services Manager – Governance & Innovation Manager - Governance & Strategy Coordinator – Governance Sexton	where the holder of right of interment or responsible person cannot be found In consultation with Council
s.109(2)	power to repair the building for ceremonies or, with the consent of the Secretary, take down, remove and dispose of a building for ceremonies	Chief Executive Officer Director – Corporate Development Director - Corporate Services Manager – Governance & Innovation Manager - Governance & Strategy Coordinator – Governance	where the holder of right of interment or responsible person cannot be found In consultation with Council
s.110(1)	power to maintain, repair or restore a memorial or place of interment from other funds if unable to find right of interment holder. with consent of the Secretary	Not Delegated	
s.110(2)	power to maintain, repair or restore any building for ceremonies from other funds if unable to find responsible person and with consent of the Secretary	Not Delegated	
s. 110A	power to use cemetery trust funds or other funds for the purposes of establishing, maintaining, repairing or restoring any memorial or place of interment of any deceased identified veteran	Not Delegated	

CEMETERIES AND CREMATORIA ACT 2003			
### The provisions of this Act apply to Councils appointed as a cemetery trust under section 5 of this Act, and also apply to Councils appointed to manage a public cemetery under section 8(1)(a)(ii) as though it were a cemetery trust (see section 53)			
Column 1	Column 2	Column 3	Column 4
PROVISION	THING DELEGATED	DELEGATE	CONDITIONS & LIMITATIONS
s.111	power to enter into agreement with a holder of the right of interment to maintain a memorial or place of interment	Chief Executive Officer Director - Corporate Development Director - Corporate Services Manager - Governance & Innovation Manager - Governance & Strategy Coordinator - Governance	
s.112	power to sell and supply memorials	Chief Executive Officer Director - Corporate Development Director - Corporate Services Manager - Governance & Innovation Manager - Governance & Strategy Coordinator - Governance Senior Administrative Officer Administrative Officer	
s.116(4)	duty to notify the Secretary of an interment authorisation granted	Chief Executive Officer Director - Corporate Development Director - Corporate Services Manager - Governance & Innovation Manager - Governance & Strategy Coordinator - Governance	

CEMETERIES AND CREMATORIA ACT 2003			
### The provisions of this Act apply to Councils appointed as a cemetery trust under section 5 of this Act, and also apply to Councils appointed to manage a public cemetery under section 8(1)(a)(ii) as though it were a cemetery trust (see section 53)			
Column 1	Column 2	Column 3	Column 4
PROVISION	THING DELEGATED	DELEGATE	CONDITIONS & LIMITATIONS
s.116(5)	power to require an applicant to produce evidence of the right of interment holder's consent to application	Chief Executive Officer Director - Corporate Development Director - Corporate Services Manager - Governance & Innovation Manager - Governance & Strategy Coordinator - Governance Senior Administrative Officer Administrative Officer	
s.118	power to grant an interment authorisation if satisfied that the requirements of Division 2 of Part 8 have been met	Chief Executive Officer Director - Corporate Development Director - Corporate Services Manager - Governance & Innovation Manager - Governance & Strategy Coordinator - Governance Senior Administrative Officer Administrative Officer	
s.119	power to set terms and conditions for interment authorisations	Chief Executive Officer Director - Corporate Development Director - Corporate Services Manager - Governance & Innovation Manager - Governance & Strategy Coordinator - Governance Senior Administrative Officer Administrative Officer	

CEMETERIES AND CREMATORIA ACT 2003			
### The provisions of this Act apply to Councils appointed as a cemetery trust under section 5 of this Act, and also apply to Councils appointed to manage a public cemetery under section 8(1)(a)(ii) as though it were a cemetery trust (see section 53)			
Column 1	Column 2	Column 3	Column 4
PROVISION	THING DELEGATED	DELEGATE	CONDITIONS & LIMITATIONS
s.145	duty to comply with an order made by the Magistrates' Court or a coroner	Chief Executive Officer Director - Corporate Development Director - Corporate Services Manager - Governance & Innovation Manager - Governance & Strategy Coordinator - Governance Senior Administrative Officer Administrative Officer	
s.150 & 152(1)	power to authorise the interment or cremation of body parts if the requirements of Division 1 of Part 11 are met	Chief Executive Officer Director - Corporate Development Director - Corporate Services Manager - Governance & Innovation Manager - Governance & Strategy Coordinator - Governance Senior Administrative Officer Administrative Officer	

CEMETERIES AND CREMATORIA ACT 2003			
### The provisions of this Act apply to Councils appointed as a cemetery trust under section 5 of this Act, and also apply to Councils appointed to manage a public cemetery under section 8(1)(a)(ii) as though it were a cemetery trust (see section 53)			
Column 1	Column 2	Column 3	Column 4
PROVISION	THING DELEGATED	DELEGATE	CONDITIONS & LIMITATIONS
s.151	function of receiving applications to inter or cremate body parts	Chief Executive Officer Director - Corporate Development Director - Corporate Services Manager - Governance & Innovation Manager - Governance & Strategy Coordinator - Governance Senior Administrative Officer Administrative Officer	
s.152(2)	power to impose terms and conditions on authorisation granted under section 150.	Chief Executive Officer Director - Corporate Development Director - Corporate Services Manager - Governance & Innovation Manager - Governance & Strategy Coordinator - Governance Senior Administrative Officer Administrative Officer	
Schedule 1 clause 8(3)	power to permit members to participate in a particular meeting by telephone, closed-circuit television or any other means of communication	Chief Executive Officer Director - Corporate Development Director - Corporate Services Manager - Governance & Innovation Manager - Governance & Strategy Coordinator - Governance	Meetings held in accordance with meeting procedure local law

CEMETERIES AND CREMATORIA ACT 2003

The provisions of this Act apply to Councils appointed as a cemetery trust under section 5 of this Act, and also apply to Councils appointed to manage a public cemetery under section 8(1)(a)(ii) as though it were a cemetery trust (see section 53)

Column 1	Column 2	Column 3	Column 4
PROVISION	THING DELEGATED	DELEGATE	CONDITIONS & LIMITATIONS
Schedule 1 clause 8(8)	power to regulate own proceedings	Chief Executive Officer Director - Corporate Development Director - Corporate Services Manager - Governance & Innovation Manager - Governance & Strategy Coordinator - Governance	Meetings held in accordance with meeting procedure local law subject to clause 8

CEMETERIES AND CREMATORIA REGULATIONS 2015			
[##These provisions apply to Councils appointed as a cemetery trust under section 5 of the <i>Cemeteries and Crematoria Act</i> 2003, and also apply to Councils appointed to manage a public cemetery under section 8(1)(a)(ii) as though it were a cemetery trust (see section 53)			
Column 1	Column 2	Column 3	Column 4
PROVISION	THING DELEGATED	DELEGATE	CONDITIONS & LIMITATIONS
r.24	duty to ensure that cemetery complies with depth of burial requirements	Chief Executive Officer Director – Corporate Development Director - Corporate Services Manager – Governance & Innovation Manager - Governance & Strategy Coordinator – Governance Senior Administrative Officer Administrative Officer Sexton	
r.25	duty to ensure that the cemetery complies with the requirements for interment in concrete-lined graves	Chief Executive Officer Director – Corporate Development Director - Corporate Services Manager – Governance & Innovation Manager - Governance & Strategy Coordinator - Governance Senior Administrative Officer Administrative Officer Sexton	
r.36	duty to provide statement that alternative vendors or supplier of monuments exist	Chief Executive Officer Director – Corporate Development Director - Corporate Services Manager – Governance & Innovation Manager - Governance & Strategy Coordinator - Governance Senior Administrative Officer Administrative Officer	

CEMETERIES AND CREMATORIA REGULATIONS 2015			
[##These provisions apply to Councils appointed as a cemetery trust under section 5 of the <i>Cemeteries and Crematoria Act 2003</i> , and also apply to Councils appointed to manage a public cemetery under section 8(1)(a)(ii) as though it were a cemetery trust (see section 53)			
Column 1	Column 2	Column 3	Column 4
PROVISION	THING DELEGATED	DELEGATE	CONDITIONS & LIMITATIONS
r. 40	power to approve a person to play sport within a public cemetery	Chief Executive Officer Director – Corporate Development Director - Corporate Services Manager – Governance & Innovation Manager - Governance & Strategy Coordinator – Governance	
r. 41(1)	power to approve fishing and bathing within a public cemetery	Chief Executive Officer Director – Corporate Development Director - Corporate Services Manager – Governance & Innovation Manager - Governance & Strategy Coordinator – Governance	
r. 42(1)	power to approve hunting within a public cemetery	Chief Executive Officer Director – Corporate Development Director - Corporate Services Manager – Governance & Innovation Manager - Governance & Strategy Coordinator – Governance	
r. 43	power to approve camping within a public cemetery	Chief Executive Officer Director – Corporate Development Director - Corporate Services Manager – Governance & Innovation Manager - Governance & Strategy Coordinator – Governance	
r. 45(1)	power to approve the removal of plants within a	Chief Executive Officer	

CEMETERIES AND CREMATORIA REGULATIONS 2015			
[##These provisions apply to Councils appointed as a cemetery trust under section 5 of the <i>Cemeteries and Crematoria Act 2003</i> , and also apply to Councils appointed to manage a public cemetery under section 8(1)(a)(ii) as though it were a cemetery trust (see section 53)			
Column 1	Column 2	Column 3	Column 4
PROVISION	THING DELEGATED	DELEGATE	CONDITIONS & LIMITATIONS
	public cemetery	Director – Corporate Development Director - Corporate Services Manager – Governance & Innovation Manager - Governance & Strategy Coordinator – Governance	
r.46	power to approve certain activities under the Regulations if satisfied of regulation (1)(a)-(c)	Chief Executive Officer Director – Corporate Development Director - Corporate Services Manager – Governance & Innovation Manager - Governance & Strategy Coordinator – Governance	
r. 47(3)	power to approve the use of fire in a public cemetery	Chief Executive Officer Director – Corporate Development Director - Corporate Services	
r.48(2)	power to approve a person to drive, ride or use a vehicle on any surface other than a road, track or parking area	Chief Executive Officer Director – Corporate Development Director - Corporate Services Manager – Governance & Innovation Manager - Governance & Strategy Coordinator – Governance Sexton	Advice should be sought from the Sexton as required before exercising this power
Note: Schedule 2 contains Model Rules – only applicable if the cemetery trust has not made its own cemetery trust rules			
Schedule 2, clause 4	power to approve the carrying out of an activity referred to in rules 8, 16, 17 and 18 of Schedule 2	Chief Executive Officer Director – Corporate Development Director - Corporate Services Manager – Governance & Innovation Manager - Governance & Strategy Coordinator – Governance	see note above regarding model rules

CEMETERIES AND CREMATORIA REGULATIONS 2015			
[##These provisions apply to Councils appointed as a cemetery trust under section 5 of the <i>Cemeteries and Crematoria Act 2003</i> , and also apply to Councils appointed to manage a public cemetery under section 8(1)(a)(ii) as though it were a cemetery trust (see section 53)			
Column 1	Column 2	Column 3	Column 4
PROVISION	THING DELEGATED	DELEGATE	CONDITIONS & LIMITATIONS
Schedule 2, clause 5(1)	duty to display the hours during which pedestrian access is available to the cemetery	Chief Executive Officer Director – Corporate Development Director - Corporate Services Manager – Governance & Innovation Manager - Governance & Strategy Coordinator - Governance Sexton	see note above regarding model rules
Schedule 2, clause 5(2)	duty to notify the Secretary of, (a) the hours during which pedestrian access is available to the cemetery; and (b) any changes to those hours	Chief Executive Officer Director – Corporate Development Director - Corporate Services Manager – Governance & Innovation Manager - Governance & Strategy Coordinator - Governance	see note above regarding model rules
Schedule 2, clause 6(1)	power to give directions regarding the manner in which a funeral is to be conducted	Chief Executive Officer Director – Corporate Development Director - Corporate Services Manager – Governance & Innovation Manager - Governance & Strategy Coordinator - Governance Senior Administrative Officer Administrative Officer Sexton	see note above regarding model rules
Schedule 2, clause 7(1)	power to give directions regarding the dressing of places of interment and memorials	Chief Executive Officer Director – Corporate Development Director - Corporate Services Manager – Governance &	see note above regarding model rules Advice should be sought from the Sexton as required before exercising

CEMETERIES AND CREMATORIA REGULATIONS 2015			
[##These provisions apply to Councils appointed as a cemetery trust under section 5 of the <i>Cemeteries and Crematoria Act 2003</i> , and also apply to Councils appointed to manage a public cemetery under section 8(1)(a)(ii) as though it were a cemetery trust (see section 53)			
Column 1	Column 2	Column 3	Column 4
PROVISION	THING DELEGATED	DELEGATE	CONDITIONS & LIMITATIONS
		Innovation Manager - Governance & Strategy Coordinator - Governance Senior Administrative Officer Administrative Officer Sexton	this power
Schedule 2, clause 8	power to approve certain mementos on a memorial	Chief Executive Officer Director - Corporate Development Director - Corporate Services Manager - Governance & Innovation Manager - Governance & Strategy Coordinator - Governance Senior Administrative Officer Administrative Officer	see note above regarding model rules
Schedule 2, clause 11(1)	power to remove objects from a memorial or place of interment	Chief Executive Officer Director - Corporate Development Director - Corporate Services Manager - Governance & Innovation Manager - Governance & Strategy Coordinator - Governance Sexton	see note above regarding model rules
Schedule 2, clause 11(2)	duty to ensure objects removed under sub rule (1) are disposed of in an appropriate manner	Chief Executive Officer Director - Corporate Development Director - Corporate Services Manager - Governance & Innovation Manager - Governance & Strategy Coordinator - Governance	see note above regarding model rules

CEMETERIES AND CREMATORIA REGULATIONS 2015			
[##These provisions apply to Councils appointed as a cemetery trust under section 5 of the <i>Cemeteries and Crematoria Act 2003</i> , and also apply to Councils appointed to manage a public cemetery under section 8(1)(a)(ii) as though it were a cemetery trust (see section 53)			
Column 1	Column 2	Column 3	Column 4
PROVISION	THING DELEGATED	DELEGATE	CONDITIONS & LIMITATIONS
		Sexton	
Schedule 2, clause 12	power to inspect any work being carried out on memorials, places of interment and buildings for ceremonies	Chief Executive Officer Director – Corporate Development Director - Corporate Services Manager – Governance & Innovation Manager - Governance & Strategy Coordinator - Governance Sexton	see note above regarding model rules
Schedule 2, clause 14	power to approve an animal to enter into or remain in a cemetery	Chief Executive Officer Director – Corporate Development Director - Corporate Services Manager – Governance & Innovation Manager - Governance & Strategy Coordinator – Governance Sexton	see note above regarding model rules
Schedule 2, clause 16(1)	power to approve construction and building within a cemetery	Not Delegated	see note above regarding model rules Does not apply to a Cemetery Trust when carrying out its own functions or to an employee, agent or contractor of the Cemetery Trust
Schedule 2, clause 17(1)	power to approve action to disturb or demolish property of the cemetery trust	Not Delegated	see note above regarding model rules

CEMETERIES AND CREMATORIA REGULATIONS 2015

[##These provisions apply to Councils appointed as a cemetery trust under section 5 of the *Cemeteries and Crematoria Act 2003*, and also apply to Councils appointed to manage a public cemetery under section 8(1)(a)(ii) as though it were a cemetery trust (see section 53)

Column 1	Column 2	Column 3	Column 4
PROVISION	THING DELEGATED	DELEGATE	CONDITIONS & LIMITATIONS
Schedule 2, clause 18(1)	power to approve digging or planting within a cemetery	Chief Executive Officer Director – Corporate Development Director - Corporate Services Manager – Governance & Innovation Manager - Governance & Strategy Coordinator - Governance Sexton	see note above regarding model rules



INSTRUMENT OF DELEGATION COUNCIL TO COUNCIL STAFF – DOMESTIC ANIMALS, ENVIRONMENT PROTECTION & FOOD ACT

In exercise of the power conferred by section 98(1) and 86(3) of the *Local Government Act* 1989 and the other legislation referred to in the attached Schedule, the Council:

1. delegates each duty and/or function and/or power described in column 1 of the Schedule (and summarised in column 2 of the Schedule) to the member of Council staff holding, acting in or performing the duties of the office or position described opposite each such duty and/or function and/or power in column 3 of the Schedule;
2. declares that:
 - 2.1 this Instrument of Delegation is authorised by a resolution of Council passed on ~~27 February~~ 27 March 2018; and
 - 2.2 the delegation:
 - 2.2.1 comes into force immediately the common seal of Council is affixed to this Instrument of Delegation;
 - 2.2.2 remains in force until varied or revoked;
 - 2.2.3 is subject to any conditions and limitations set out in sub-paragraph 3.3, and the Schedule; and
 - 2.2.4 must be exercised in accordance with any guidelines or policies which Council from time to time adopts; and
 - 2.3 the delegate must not determine the issue, take the action or do the act or thing:
 - 2.3.1 if the issue, action, act or thing is an issue, action or thing which Council has previously designated as an issue, action, act or thing which must be the subject of a Resolution of Council; or
 - 2.3.2 if the determining of the issue, taking of the action or doing of the act or thing would or would be likely to involve a decision which is inconsistent with a
 - (a) policy; or
 - (b) strategy
 adopted by Council; or

- 2.3.3 if the determining of the issue, the taking of the action or the doing of the act or thing cannot be the subject of a lawful delegation, whether on account of section 98(1)(a)-(f) (inclusive) of the Act or otherwise; or
 - 2.3.4 the determining of the issue, the taking of the action or the doing of the act or thing is already the subject of an exclusive delegation to another member of Council staff.
3. In exercising any duty, function or power under this delegation the officer concerned will be mindful of the provisions under Division 1A – Conduct and Interests of the Local Government Act 1989.
- 3.1 The principles of these provisions will apply to delegated officers.
 - 3.2 Any disclosures under section 77A or 79 must be recorded in accordance with any guidelines or policies which Council from time to time adopts.

THE COMMON SEAL of KNOX CITY COUNCIL

was affixed pursuant to an Order of the Council

made on the ~~28 August 2017~~ 27 March 2018

in the presence of

Mayor

Chief Executive Officer

Councillor

Official Minutes of Knox City Council



SCHEDULE

Official Minutes of Knox City Council



INDEX

DOMESTIC ANIMALS ACT 1994	1
ENVIRONMENT PROTECTION ACT 1970	2
FOOD ACT 1984	4

Official Minutes of Knox City Council



DOMESTIC ANIMALS ACT 1994			
Column 1	Column 2	Column 3	Column 4
PROVISION	THING DELEGATED	DELEGATE	CONDITIONS AND LIMITATIONS
s.41A(1)	power to declare a dog to be a menacing dog	Chief Executive Officer Director – City Development Manager – City Safety & Health Coordinator - Community Laws	Council may delegate this power to an authorised officer

Official Minutes of Knox City Council

ENVIRONMENT PROTECTION ACT 1970			
Column 1	Column 2	Column 3	Column 4
PROVISION	THING DELEGATED	DELEGATE	CONDITIONS & LIMITATIONS
s.53M(3)	power to require further information	Chief Executive Officer Director – City Development Manager – City Safety & Health Coordinator- Health Compliance Environmental Health Officer Authorised Officer	
s.53M(4)	duty to advise applicant that application is not to be dealt with	Chief Executive Officer Director – City Development Manager – City Safety & Health Coordinator- Health Compliance Environmental Health Officer Authorised Officer	
s.53M(5)	duty to approve plans, issue permit or refuse permit	Chief Executive Officer Director – City Development Manager – City Safety & Health Coordinator- Health Compliance Environmental Health Officer Authorised Officer	refusal must be ratified by council or it is of no effect
s.53M(6)	power to refuse to issue septic tank permit	Chief Executive Officer Director – City Development Manager – City Safety & Health Coordinator- Health Compliance Environmental Health Officer Authorised Officer	refusal must be ratified by council or it is of no effect

ENVIRONMENT PROTECTION ACT 1970			
Column 1	Column 2	Column 3	Column 4
PROVISION	THING DELEGATED	DELEGATE	CONDITIONS & LIMITATIONS
s.53M(7)	duty to refuse to issue a permit in circumstances in (a)-(c)	Chief Executive Officer Director – City Development Manager – City Safety & Health	refusal must be ratified by council or it is of no effect

Official Minutes of Knox City Council

FOOD ACT 1984			
Column 1	Column 2	Column 3	Column 4
PROVISION	THING DELEGATED	DELEGATE	CONDITIONS & LIMITATIONS
s.19(2)(a)	power to direct by written order that the food premises be put into a clean and sanitary condition	Chief Executive Officer Director – City Development Manager – City Safety & Health Coordinator- Health Compliance Environmental Health Officer Authorised Officer	If section 19(1) applies
s.19(2)(b)	power to direct by written order that specified steps be taken to ensure that food prepared, sold or handled is safe and suitable	Chief Executive Officer Director – City Development Manager – City Safety & Health Coordinator- Health Compliance Environmental Health Officer Authorised Officer	If section 19(1) applies
s.19(3)	power to direct by written order that the food premises not be kept or used for the sale, or handling for sale, of any food, or for the preparation of any food, or for any other specified purpose, or for the use of any specified equipment or a specified process	Chief Executive Officer Director – City Development Manager – City Safety & Health Coordinator- Health Compliance Environmental Health Officer Authorised Officer	If section 19(1) applies Only in relation to temporary food premises or mobile food premises

FOOD ACT 1984			
Column 1	Column 2	Column 3	Column 4
PROVISION	THING DELEGATED	DELEGATE	CONDITIONS & LIMITATIONS
s.19(4)(a)	power to direct that an order made under section 19(3)(a) or (b), (i) be affixed to a conspicuous part of the premises, and (ii) inform the public by notice in a published newspaper or otherwise	Chief Executive Officer Director – City Development Manager – City Safety & Health	If section 19(1) applies
s.19(6)(a)	duty to revoke any order under section 19 if satisfied that an order has been complied with	Chief Executive Officer Director – City Development Manager – City Safety & Health Coordinator – Health Compliance	If section 19(1) applies
s.19(6)(b)	duty to give written notice of revocation under section 19(6)(a) if satisfied that an order has been complied with	Chief Executive Officer Director – City Development Manager – City Safety & Health Coordinator – Health Compliance Environmental Health Officer	If section 19(1) applies
s.19AA(2)	power to direct, by written order, that a person must take any of the actions described in (a)-(c).	Chief Executive Officer Director – City Development Manager – City Safety & Health Coordinator – Health Compliance	where council is the registration authority

FOOD ACT 1984			
Column 1	Column 2	Column 3	Column 4
PROVISION	THING DELEGATED	DELEGATE	CONDITIONS & LIMITATIONS
s.19AA(4)(c)	power to direct, in an order made under s.19AA(2) or a subsequent written order, that a person must ensure that any food or class of food is not removed from the premises	Chief Executive Officer Director – City Development Manager – City Safety & Health Coordinator – Health Compliance	Note: the power to direct the matters under s.19AA(4)(a) and (b) not capable of delegation and so such directions must be made by a Council resolution
s.19AA(7)	duty to revoke order issued under s.19AA and give written notice of revocation, if satisfied that that order has been complied with	Chief Executive Officer Director – City Development Manager – City Safety & Health Coordinator – Health Compliance	where council is the registration authority
s.19CB(4)(b)	power to request copy of records	Chief Executive Officer Director – City Development Manager – City Safety & Health Coordinator – Health Compliance Environmental Health Officer	where council is the registration authority
s.19E(1)(d)	power to request a copy of the food safety program	Chief Executive Officer Director – City Development Manager – City Safety & Health Coordinator – Health Compliance Environmental Health Officer	where council is the registration authority
s.19GB	power to request proprietor to provide written details of the name, qualification or experience of the current food safety supervisor	Chief Executive Officer Director – City Development Manager – City Safety & Health Coordinator – Health Compliance Environmental Health Officer	where council is the registration authority

FOOD ACT 1984			
Column 1	Column 2	Column 3	Column 4
PROVISION	THING DELEGATED	DELEGATE	CONDITIONS & LIMITATIONS
s.19M(4)(a) & (5)	power to conduct a food safety audit and take actions where deficiencies are identified	Chief Executive Officer Director – City Development Manager – City Safety & Health Coordinator- Health Compliance Environmental Health Officer	where council is the registration authority
s.19NA(1)	power to request food safety audit reports	Chief Executive Officer Director – City Development Manager – City Safety & Health Coordinator- Health Compliance Environmental Health Officer Authorised Officer	where council is the registration authority
s.19U(3)	power to waive and vary the costs of a food safety audit if there are special circumstances	Chief Executive Officer Director – City Development Manager – City Safety & Health Coordinator – Health Compliance	
s.19UA	power to charge fees for conducting a food safety assessment or inspection	Chief Executive Officer Director – City Development Manager – City Safety & Health Coordinator – Health Compliance	except for an assessment required by a declaration under section 19C or an inspection under sections 38B(1)(c) or 39.

FOOD ACT 1984			
Column 1	Column 2	Column 3	Column 4
PROVISION	THING DELEGATED	DELEGATE	CONDITIONS & LIMITATIONS
s.19W	power to direct a proprietor of a food premises to comply with any requirement under Part IIIB	Chief Executive Officer Director – City Development Manager – City Safety & Health Coordinator – Health Compliance Environmental Health Officer Authorised Officer	where council is the registration authority
s.19W(3)(a)	power to direct a proprietor of a food premises to have staff at the premises undertake training or instruction	Chief Executive Officer Director – City Development Manager – City Safety & Health Coordinator – Health Compliance Environmental Health Officer Authorised Officer	where council is the registration authority
s.19W(3)(b)	power to direct a proprietor of a food premises to have details of any staff training incorporated into the minimum records required to be kept or food safety program of the premises	Chief Executive Officer Director – City Development Manager – City Safety & Health Coordinator – Health Compliance Environmental Health Officer Authorised Officer	where council is the registration authority
---	power to register, renew or transfer registration	Chief Executive Officer Director – City Development Manager – City Safety & Health Coordinator – Health Compliance	where council is the registration authority refusal to grant/renew/transfer registration must be ratified by Council or the CEO (see section 58A(2))

FOOD ACT 1984			
Column 1	Column 2	Column 3	Column 4
PROVISION	THING DELEGATED	DELEGATE	CONDITIONS & LIMITATIONS
s.38AA(5)	power to (a) request further information; or (b) advise the proprietor that the premises must be registered if the premises are not exempt	Chief Executive Officer Director – City Development Manager – City Safety & Health Coordinator – Health Compliance Environmental Health Officer Authorised Officer	where council is the registration authority
s.38AB(4)	power to fix a fee for the receipt of a notification under section 38AA in accordance with a declaration under subsection (1)	Chief Executive Officer Director – City Development Manager – City Safety & Health Coordinator – Health Compliance	where council is the registration authority
s.38A(4)	power to request a copy of a completed food safety program template	Chief Executive Officer Director – City Development Manager – City Safety & Health Coordinator – Health Compliance Environmental Health Officer	where council is the registration authority
s.38B(1)(a)	duty to assess the application and determine which class of food premises under section 19C the food premises belongs	Chief Executive Officer Director – City Development Manager – City Safety & Health Coordinator – Health Compliance Environmental Health Officer	where council is the registration authority

FOOD ACT 1984			
Column 1	Column 2	Column 3	Column 4
PROVISION	THING DELEGATED	DELEGATE	CONDITIONS & LIMITATIONS
s.38B(1)(b)	duty to ensure proprietor has complied with requirements of section 38A	Chief Executive Officer Director – City Development Manager – City Safety & Health Coordinator – Health Compliance Environmental Health Officer Authorised Officer	where council is the registration authority
s.38B(2)	duty to be satisfied of the matters in section 38B(2)(a)-(b)	Chief Executive Officer Director – City Development Manager – City Safety & Health Coordinator – Health Compliance Environmental Health Officer Authorised Officer	where council is the registration authority
s.38D(1)	duty to ensure compliance with the applicable provisions of section 38C and inspect the premises if required by section 39	Chief Executive Officer Director – City Development Manager – City Safety & Health Coordinator – Health Compliance Environmental Health Officer Authorised Officer	where council is the registration authority
s.38D(2)	duty to be satisfied of the matters in section 38D(2)(a)-(d)	Chief Executive Officer Director – City Development Manager – City Safety & Health Coordinator – Health Compliance Environmental Health Officer Authorised Officer	where council is the registration authority

FOOD ACT 1984			
Column 1	Column 2	Column 3	Column 4
PROVISION	THING DELEGATED	DELEGATE	CONDITIONS & LIMITATIONS
s.38D(3)	power to request copies of any audit reports	Chief Executive Officer Director – City Development Manager – City Safety & Health Coordinator – Health Compliance Environmental Health Officer Authorised Officer	where council is the registration authority
s.38E(2)	power to register the food premises on a conditional basis	Chief Executive Officer Director – City Development Manager – City Safety & Health Coordinator – Health Compliance	where council is the registration authority; not exceeding the prescribed time limit defined under subsection (5).
s.38E(4)	duty to register the food premises when conditions are satisfied	Chief Executive Officer Director – City Development Manager – City Safety & Health Coordinator – Health Compliance	where council is the registration authority
s.38F(3)(b)	power to require proprietor to comply with requirements of this Act	Chief Executive Officer Director – City Development Manager – City Safety & Health Coordinator – Health Compliance Environmental Health Officer Authorised Officer	where council is the registration authority
s.39A	power to register, renew or transfer food premises despite minor defects	Chief Executive Officer Director – City Development Manager – City Safety & Health Coordinator – Health Compliance	where council is the registration authority only if satisfied of matters in subsections (2)(a)-(c)

FOOD ACT 1984			
Column 1	Column 2	Column 3	Column 4
PROVISION	THING DELEGATED	DELEGATE	CONDITIONS & LIMITATIONS
s.40(2)	power to incorporate the certificate of registration in one document with any certificate of registration under Part 6 of the <i>Public Health and Wellbeing Act 2008</i>	Chief Executive Officer Director – City Development Manager – City Safety & Health Coordinator – Health Compliance Environmental Health Officer	
s.40C(2)	power to grant or renew the registration of food premises for a period of less than 1 year	Chief Executive Officer Director – City Development Manager – City Safety & Health Coordinator – Health Compliance	where council is the registration authority
s.40D(1)	power to suspend or revoke the registration of food premises	Chief Executive Officer Director – City Development Manager – City Safety & Health Coordinator – Health Compliance	where council is the registration authority
s.43F(6)	duty to be satisfied that registration requirements under Division 3 have been met prior to registering, transferring or renewing registration of a component of a food business	Chief Executive Officer Director – City Development Manager – City Safety & Health Coordinator – Health Compliance Environmental Health Officer	where council is the registration authority
s.43F(7)	power to register the components of the food business that meet requirements in Division 3 and power to refuse to register the components that do not meet the requirements	Chief Executive Officer Director – City Development Manager – City Safety & Health Coordinator – Health Compliance Environmental Health Officer	where council is the registration authority

FOOD ACT 1984			
Column 1	Column 2	Column 3	Column 4
PROVISION	THING DELEGATED	DELEGATE	CONDITIONS & LIMITATIONS
s.46(5)	power to institute proceedings against another person where the offence was due to an act or default by that other person and where the first person charged could successfully defend a prosecution, without proceedings first being instituted against the person first charged	Chief Executive Officer Director – City Development Manager – City Safety & Health Coordinator – Health Compliance Environmental Health Officer	where council is the registration authority



INSTRUMENT OF DELEGATION

In exercise of the power conferred by section 98(1) of the *Local Government Act* 1989 and the other legislation referred to in the attached Schedule, the Council:

1. delegates each duty and/or function and/or power described in column 1 of the Schedule (and summarised in column 2 of the Schedule) to the member of Council staff holding, acting in or performing the duties of the office or position described opposite each such duty and/or function and/or power in column 3 of the Schedule;
2. declares that:
 - 2.1 this Instrument of Delegation is authorised by a resolution of Council passed on ~~2 February~~ 27 March 2018; and
 - 2.2 the delegation:
 - 2.2.1 comes into force immediately the common seal of Council is affixed to this Instrument of Delegation;
 - 2.2.2 remains in force until varied or revoked;
 - 2.2.3 is subject to any conditions and limitations set out in sub-paragraph 3.3, and the Schedule; and
 - 2.2.4 must be exercised in accordance with any guidelines or policies which Council from time to time adopts; and
 - 2.3 the delegate must not determine the issue, take the action or do the act or thing:
 - 2.3.1 if the issue, action, act or thing is an issue, action or thing which Council has previously designated as an issue, action, act or thing which must be the subject of a Resolution of Council; or
 - 2.3.2 if the determining of the issue, taking of the action or doing of the act or thing would or would be likely to involve a decision which is inconsistent with a
 - (a) policy; or
 - (b) strategy
 adopted by Council; or
 - 2.3.3 if the determining of the issue, the taking of the action or the doing of the act or thing cannot be the subject of a lawful delegation, whether on account of section 98(1)(a)-(f) (inclusive) of the Act or otherwise; or

2.3.4 the determining of the issue, the taking of the action or the doing of the act or thing is already the subject of an exclusive delegation to another member of Council staff.

3. In exercising any duty, function or power under this delegation the officer concerned will be mindful of the provisions under Division 1A – Conduct and Interests of the Local Government Act 1989.

3.1 The principles of these provisions apply to delegated officers.

3.2 Any disclosures under section 77A or 79 must be recorded in accordance with any guidelines or policies which Council from time to time adopts.

THE COMMON SEAL of KNOX CITY COUNCIL

was affixed pursuant to an Order of the Council

made on the ~~2 February~~ 27 March 2018

in the presence of

Mayor

Chief Executive Officer

Councillor

Official Minutes of Knox City Council



SCHEDULE

Official Minutes of Knox City Council



INDEX

RAIL SAFETY (LOCAL OPERATIONS) ACT 2006..... 1
ROAD MANAGEMENT ACT 2004 5
ROAD MANAGEMENT (GENERAL) REGULATIONS 2016 34
ROAD MANAGEMENT (WORKS AND INFRASTRUCTURE) REGULATIONS 2015 39

Official Minutes of Knox City Council



RAIL SAFETY (LOCAL OPERATIONS) ACT 2006			
Column 1	Column 2	Column 3	Column 4
PROVISION	THING DELEGATED	DELEGATE	CONDITIONS AND LIMITATIONS
s.33	duty to comply with a direction of the Safety Director under this section	Chief Executive Officer Director - Engineering & Infrastructure Manager - Operations	where council is a utility under section 3
s.33A	duty to comply with a direction of the Safety Director to give effect to arrangements under this section	Chief Executive Officer Director - Engineering & Infrastructure Manager - Operations	duty of council as a road authority under the <i>Road Management Act 2004</i>
s.34	duty to comply with a direction of the Safety Director to alter, demolish or take away works carried out contrary to a direction under section 33(1)	Chief Executive Officer Director - Engineering & Infrastructure Manager - Operations	where council is a utility under section 3
s.34C(2)	function of entering into safety interface agreements with rail infrastructure manager	Chief Executive Officer Director - Engineering & Infrastructure Manager - Operations	where council is the relevant road authority
s.34D(1)	function of working in conjunction with rail infrastructure manager in determining whether risks to safety need to be managed	Chief Executive Officer Director - Engineering & Infrastructure Manager - Operations	where council is the relevant road authority

RAIL SAFETY (LOCAL OPERATIONS) ACT 2006			
Column 1	Column 2	Column 3	Column 4
PROVISION	THING DELEGATED	DELEGATE	CONDITIONS AND LIMITATIONS
s.34D(2)	function of receiving written notice of opinion	Chief Executive Officer Director - Engineering & Infrastructure Manager - Operations	where council is the relevant road authority
s.34D(4)	function of entering into safety interface agreement with infrastructure manager	Chief Executive Officer Director - Engineering & Infrastructure Manager - Operations	where council is the relevant road authority
s.34E(1)(a)	duty to identify and assess risks to safety	Chief Executive Officer Director - Engineering & Infrastructure Manager - Operations	where council is the relevant road authority
s.34E(1)(b)	duty to determine measures to manage any risks identified and assessed having regard to items set out in section 34E(2)(a)-(c)	Chief Executive Officer Director - Engineering & Infrastructure Manager - Operations	where council is the relevant road authority
s.34E(3)	duty to seek to enter into a safety interface agreement with rail infrastructure manager	Chief Executive Officer Director - Engineering & Infrastructure Manager - Operations	where council is the relevant road authority

RAIL SAFETY (LOCAL OPERATIONS) ACT 2006			
Column 1	Column 2	Column 3	Column 4
PROVISION	THING DELEGATED	DELEGATE	CONDITIONS AND LIMITATIONS
s.34F(1)(a)	duty to identify and assess risks to safety, if written notice has been received under section 34D(2)(a)	Chief Executive Officer Director - Engineering & Infrastructure Manager - Operations	where council is the relevant road authority
s.34F(1)(b)	duty to determine measures to manage any risks identified and assessed, if written notice has been received under section 34D(2)(a)	Chief Executive Officer Director - Engineering & Infrastructure Manager - Operations	where council is the relevant road authority
s.34F(2)	duty to seek to enter into a safety interface agreement with rail infrastructure manager	Chief Executive Officer Director - Engineering & Infrastructure Manager - Operations	where council is the relevant road authority
s.34H	power to identify and assess risks to safety as required under sections 34B, 34C, 34D, 34E or 34F in accordance with subsections (a)-(c)	Chief Executive Officer Director - Engineering & Infrastructure Manager - Operations	where council is the relevant road authority
s.34I	function of entering into safety interface agreements	Chief Executive Officer Director - Engineering & Infrastructure Manager - Operations	where council is the relevant road authority

RAIL SAFETY (LOCAL OPERATIONS) ACT 2006			
Column 1	Column 2	Column 3	Column 4
PROVISION	THING DELEGATED	DELEGATE	CONDITIONS AND LIMITATIONS
s.34J(2)	function of receiving notice from Safety Director	Chief Executive Officer Director - Engineering & Infrastructure Manager - Operations	where council is the relevant road authority
s.34J(7)	duty to comply with a direction of the Safety Director given under section 34J(5)	Chief Executive Officer Director - Engineering & Infrastructure Manager - Operations	where council is the relevant road authority
s.34K(2)	duty to maintain a register of items set out in subsections (a)-(b)	Chief Executive Officer Director - Engineering & Infrastructure Manager - Operations	where council is the relevant road authority

ROAD MANAGEMENT ACT 2004			
Column 1	Column 2	Column 3	Column 4
PROVISION	THING DELEGATED	DELEGATE	CONDITIONS & LIMITATIONS
s.11(1)	power to declare a road by publishing a notice in the Government Gazette	Chief Executive Officer Director – Corporate Development Director - Corporate Services Manager – Governance & Innovation Manager – Business & Financial Services Director - Engineering & Infrastructure Manager - Sustainable Infrastructure	obtain consent in circumstances specified in section 11(2)
s.11(8)	power to name a road or change the name of a road by publishing notice in Government Gazette	Chief Executive Officer Director – Corporate Development Director - Corporate Services Manager – Governance & Innovation Manager – Business & Financial Services Coordinator – Property Management	

ROAD MANAGEMENT ACT 2004			
Column 1	Column 2	Column 3	Column 4
PROVISION	THING DELEGATED	DELEGATE	CONDITIONS & LIMITATIONS
s.11(9)(b)	duty to advise Registrar	Chief Executive Officer Director – Corporate Development Director - Corporate Services Manager – Governance & Innovation Manager – Business & Financial Services Coordinator – Property Management	
s.11(10)	duty to inform Secretary to Department of Environment, Land, Water and Planning of declaration etc.	Chief Executive Officer Director – Corporate Development Director - Corporate Services Manager – Governance & Innovation Manager – Business & Financial Services Director - Engineering & Infrastructure Manager - Sustainable Infrastructure	clause subject to section 11(10A)

ROAD MANAGEMENT ACT 2004			
Column 1	Column 2	Column 3	Column 4
PROVISION	THING DELEGATED	DELEGATE	CONDITIONS & LIMITATIONS
s.11(10A)	duty to inform Secretary to Department of Environment, Land, Water and Planning or nominated person	Chief Executive Officer Director – Corporate Development Director - Corporate Services Manager – Governance & Innovation Manager – Business & Financial Services Director - Engineering & Infrastructure Manager - Sustainable Infrastructure	where council is the coordinating road authority
s.12(2)	power to discontinue road or part of a road	Chief Executive Officer Director – Corporate Development Director - Corporate Services Manager – Governance & Innovation Manager – Business & Financial Services Director - Engineering & Infrastructure Manager - Sustainable Infrastructure	were council is the coordinating road authority

ROAD MANAGEMENT ACT 2004			
Column 1	Column 2	Column 3	Column 4
PROVISION	THING DELEGATED	DELEGATE	CONDITIONS & LIMITATIONS
s.12(4)	power to publish, and provide copy, notice of proposed discontinuance	Chief Executive Officer Director – Corporate Development Director - Corporate Services Manager – Governance & Innovation Manager – Business & Financial Services Director - Engineering & Infrastructure Manager - Sustainable Infrastructure	power of coordinating road authority where it is the discontinuing body unless subsection (11) applies
s.12(5)	duty to consider written submissions received within 28 days of notice	Chief Executive Officer Director – Engineering & Infrastructure Manager – Sustainable Infrastructure Director – Corporate Development Manager – Governance & Innovation Manager – Business & Financial Services Coordinator – Property Management	duty of coordinating road authority where it is the discontinuing body unless subsection (11) applies

ROAD MANAGEMENT ACT 2004			
Column 1	Column 2	Column 3	Column 4
PROVISION	THING DELEGATED	DELEGATE	CONDITIONS & LIMITATIONS
s.12(6)	function of hearing a person in support of their written submission	Chief Executive Officer Director – Engineering & Infrastructure Manager – Sustainable Infrastructure Director – Corporate Development Manager – Governance & Innovation Manager – Business & Financial Services Coordinator – Property Management	function of coordinating road authority where it is the discontinuing body unless subsection (11) applies
s.12(7)	duty to fix day, time and place of meeting under subsection (6) and to give notice	Chief Executive Officer Director – Corporate Development Manager – Governance & Innovation Manager – Business & Financial Services Coordinator – Property Management	duty of coordinating road authority where it is the discontinuing body unless subsection (11) applies
s.12(10)	duty to notify of decision made	Chief Executive Officer Director – Corporate Development Manager – Governance & Innovation Manager – Business & Financial Services Coordinator – Property Management	duty of coordinating road authority where it is the discontinuing body does not apply where an exemption is specified by the regulations or given by the Minister

ROAD MANAGEMENT ACT 2004			
Column 1	Column 2	Column 3	Column 4
PROVISION	THING DELEGATED	DELEGATE	CONDITIONS & LIMITATIONS
s.13(1)	power to fix a boundary of a road by publishing notice in Government Gazette	Chief Executive Officer Director – Corporate Development Director - Corporate Services Manager – Governance & Innovation Manager – Business & Financial Services Director - City Development Manager - City Futures	power of coordinating road authority and obtain consent under section 13(3) and section 13(4) as appropriate
s.14(4)	function of receiving notice from VicRoads	Chief Executive Officer Director - Engineering & Infrastructure	
s.14(7)	power to appeal against decision of VicRoads	Chief Executive Officer Director - Engineering & Infrastructure	
s.15(1)	power to enter into arrangement with another road authority, utility or a provider of public transport to transfer a road management function of the road authority to the other road authority, utility or provider of public transport	Chief Executive Officer Director - Engineering & Infrastructure	
s.15(1A)	power to enter into arrangement with a utility to transfer a road management function of the utility to the road authority	Chief Executive Officer Director - Engineering & Infrastructure	

ROAD MANAGEMENT ACT 2004			
Column 1	Column 2	Column 3	Column 4
PROVISION	THING DELEGATED	DELEGATE	CONDITIONS & LIMITATIONS
s.15(2)	duty to include details of arrangement in public roads register	Chief Executive Officer Director - Engineering & Infrastructure Manager – Sustainable Infrastructure	
s.16(7)	power to enter into an arrangement under section 15	Chief Executive Officer Director - Engineering & Infrastructure	
s.16(8)	duty to enter details of determination in public roads register	Chief Executive Officer Director - Engineering & Infrastructure Manager – Sustainable Infrastructure	
s.17(2)	duty to register public road in public roads register	Chief Executive Officer Director - Engineering & Infrastructure Manager – Sustainable Infrastructure	where council is the coordinating road authority
s.17(3)	power to decide that a road is reasonably required for general public use	Chief Executive Officer Director - Engineering & Infrastructure Manager – Sustainable Infrastructure	where council is the coordinating road authority

ROAD MANAGEMENT ACT 2004			
Column 1	Column 2	Column 3	Column 4
PROVISION	THING DELEGATED	DELEGATE	CONDITIONS & LIMITATIONS
s.17(3)	duty to register a road reasonably required for general public use in public roads register	Chief Executive Officer Director - Engineering & Infrastructure Manager – Sustainable Infrastructure	where council is the coordinating road authority
s.17(4)	power to decide that a road is no longer reasonably required for general public use	Chief Executive Officer Director - Engineering & Infrastructure Manager – Sustainable Infrastructure	where council is the coordinating road authority
s.17(4)	duty to remove road no longer reasonably required for general public use from public roads register	Chief Executive Officer Director - Engineering & Infrastructure Manager – Sustainable Infrastructure	where council is the coordinating road authority
s.18(1)	power to designate ancillary area	Chief Executive Officer Director - Engineering & Infrastructure Manager – Sustainable Infrastructure	where council is the coordinating road authority, and obtain consent in circumstances specified in section 18(2)

ROAD MANAGEMENT ACT 2004			
Column 1	Column 2	Column 3	Column 4
PROVISION	THING DELEGATED	DELEGATE	CONDITIONS & LIMITATIONS
s.18(3)	duty to record designation in public roads register	Chief Executive Officer Director - Engineering & Infrastructure Manager – Sustainable Infrastructure	where council is the coordinating road authority
s.19(1)	duty to keep register of public roads in respect of which it is the coordinating road authority	Chief Executive Officer Director - Engineering & Infrastructure Manager – Sustainable Infrastructure	
s.19(4)	duty to specify details of discontinuance in public roads register	Chief Executive Officer Director - Engineering & Infrastructure Manager – Sustainable Infrastructure	
s.19(5)	duty to ensure public roads register is available for public inspection	Chief Executive Officer Director - Engineering & Infrastructure Manager – Sustainable Infrastructure	
s.21	function of replying to request for information or advice	Chief Executive Officer Director - Engineering & Infrastructure	obtain consent in circumstances specified in section 11(2)

ROAD MANAGEMENT ACT 2004			
Column 1	Column 2	Column 3	Column 4
PROVISION	THING DELEGATED	DELEGATE	CONDITIONS & LIMITATIONS
s.22(2)	function of commenting on proposed direction	Chief Executive Officer Director - Engineering & Infrastructure	
s.22(4)	duty to publish a copy or summary of any direction made under section 22 by the Minister in its annual report.	Chief Executive Officer Director - Corporate Development Director - Corporate Services Manager - Governance & Innovation Manager - Business & Financial Services Director - Engineering & Infrastructure Manager - Sustainable Infrastructure	
s.22(5)	duty to give effect to a direction under this section.	Chief Executive Officer Director - Engineering & Infrastructure	
s.40(1)	duty to inspect, maintain and repair a public road.	Chief Executive Officer Director - Engineering & Infrastructure	

ROAD MANAGEMENT ACT 2004			
Column 1	Column 2	Column 3	Column 4
PROVISION	THING DELEGATED	DELEGATE	CONDITIONS & LIMITATIONS
s.40(5)	power to inspect, maintain and repair a road which is not a public road	Chief Executive Officer Director - Engineering & Infrastructure Manager – Sustainable Infrastructure	
s.41(1)	power to determine the standard of construction, inspection, maintenance and repair	Chief Executive Officer Director - Engineering & Infrastructure	
s.42(1)	power to declare a public road as a controlled access road	Chief Executive Officer Director - Engineering & Infrastructure Manager – Sustainable Infrastructure	power of coordinating road authority and Schedule 2 also applies
s.42(2)	power to amend or revoke declaration by notice published in Government Gazette	Chief Executive Officer Director - Engineering & Infrastructure Manager – Sustainable Infrastructure	power of coordinating road authority and Schedule 2 also applies
s.42A(3)	duty to consult with VicRoads before road is specified	Chief Executive Officer Director - Engineering & Infrastructure Manager – Sustainable Infrastructure	where council is the coordinating road authority if road is a municipal road or part thereof

ROAD MANAGEMENT ACT 2004			
Column 1	Column 2	Column 3	Column 4
PROVISION	THING DELEGATED	DELEGATE	CONDITIONS & LIMITATIONS
s.42A(4)	power to approve Minister's decision to specify a road as a specified freight road	Chief Executive Officer Director - Engineering & Infrastructure Manager – Sustainable Infrastructure	where council is the coordinating road authority if road is a municipal road or part thereof and where road is to be specified a freight road
s.48EA	duty to notify the owner or occupier of land and provider of public transport on which rail infrastructure or rolling stock is located (and any relevant provider of public transport)	Chief Executive Officer Director - Engineering & Infrastructure Manager - Operations Coordinator - Works Services Coordinator - Parks Services Coordinator – Construction Group	where council is the responsible road authority, infrastructure manager or works manager
s.48M(3)	function of consulting with the relevant authority for purposes of developing guidelines under section 48M	Chief Executive Officer Director - Engineering & Infrastructure Manager – Sustainable Infrastructure	
s.49	power to develop and publish a road management plan	Chief Executive Officer Director - Engineering & Infrastructure Manager – Sustainable Infrastructure	

ROAD MANAGEMENT ACT 2004			
Column 1	Column 2	Column 3	Column 4
PROVISION	THING DELEGATED	DELEGATE	CONDITIONS & LIMITATIONS
s.51	power to determine standards by incorporating the standards in a road management plan	Chief Executive Officer Director - Engineering & Infrastructure Manager – Sustainable Infrastructure	
s.53(2)	power to cause notice to be published in Government Gazette of amendment etc of document in road management plan	Chief Executive Officer Director - Engineering & Infrastructure Manager – Sustainable Infrastructure	
s.54(2)	duty to give notice of proposal to make a road management plan	Chief Executive Officer Director - Engineering & Infrastructure Manager – Sustainable Infrastructure	
s.54(5)	duty to conduct a review of road management plan at prescribed intervals	Chief Executive Officer Director - Engineering & Infrastructure Manager – Sustainable Infrastructure	

ROAD MANAGEMENT ACT 2004			
Column 1	Column 2	Column 3	Column 4
PROVISION	THING DELEGATED	DELEGATE	CONDITIONS & LIMITATIONS
s.54(6)	power to amend road management plan	Chief Executive Officer Director - Engineering & Infrastructure Manager – Sustainable Infrastructure	
s.54(7)	duty to incorporate the amendments into the road management plan	Chief Executive Officer Director - Engineering & Infrastructure Manager – Sustainable Infrastructure	
s.55(1)	duty to cause notice of road management plan to be published in Government Gazette and newspaper	Chief Executive Officer Director - Engineering & Infrastructure Manager – Sustainable Infrastructure	
s.63(1)	power to consent to conduct of works on road	Chief Executive Officer Director - Engineering & Infrastructure Manager – Community Infrastructure Manager – Operations	where council is the coordinating road authority

ROAD MANAGEMENT ACT 2004			
Column 1	Column 2	Column 3	Column 4
PROVISION	THING DELEGATED	DELEGATE	CONDITIONS & LIMITATIONS
s.63(2)(e)	power to conduct or to authorise the conduct of works in, on, under or over a road in an emergency	Chief Executive Officer Director - Engineering & Infrastructure Manager – Community Infrastructure Manager – Operations	where council is the infrastructure manager
s.64(1)	duty to comply with clause 13 of Schedule 7	Chief Executive Officer Director - Engineering & Infrastructure Manager – Community Infrastructure Coordinator - Project Delivery Director - City Development Manager - City Safety & Health Coordinator - Local Laws Team Leader - Parking Services Team Leader - Asset Preservation Local Laws Officers	where council is the infrastructure manager or works manager

ROAD MANAGEMENT ACT 2004			
Column 1	Column 2	Column 3	Column 4
PROVISION	THING DELEGATED	DELEGATE	CONDITIONS & LIMITATIONS
s.66(1)	power to consent to structure etc	Chief Executive Officer Director - Engineering & Infrastructure Manager – Community Infrastructure Coordinator - Project Delivery Director - City Development Manager - City Safety & Health Coordinator - Local Laws Team Leader - Parking Services Team Leader - Asset Preservation Local Laws Officers	where council is the coordinating road authority
s.67(2)	function of receiving the name & address of the person responsible for distributing the sign or bill	Chief Executive Officer Director - Engineering & Infrastructure Manager – Community Infrastructure Coordinator - Project Delivery Director - City Development Manager - City Safety & Health Coordinator - Local Laws Team Leader - Parking Services Team Leader - Asset Preservation Local Laws Officers	where council is the coordinating road authority

ROAD MANAGEMENT ACT 2004			
Column 1	Column 2	Column 3	Column 4
PROVISION	THING DELEGATED	DELEGATE	CONDITIONS & LIMITATIONS
s.67(3)	power to request information	Chief Executive Officer Director - Engineering & Infrastructure Manager – Community Infrastructure Coordinator - Project Delivery Director - City Development Manager - City Safety & Health Coordinator - Local Laws Team Leader - Parking Services Team Leader - Asset Preservation Local Laws Officers	where council is the coordinating road authority
s.68(2)	power to request information	Chief Executive Officer Director - Engineering & Infrastructure Manager – Community Infrastructure Coordinator - Project Delivery Director - City Development Manager - City Safety & Health Coordinator - Local Laws Team Leader - Parking Services Team Leader - Asset Preservation Local Laws Officers	where council is the coordinating road authority
s.71(3)	power to appoint an authorised officer	Chief Executive Officer	

ROAD MANAGEMENT ACT 2004			
Column 1	Column 2	Column 3	Column 4
PROVISION	THING DELEGATED	DELEGATE	CONDITIONS & LIMITATIONS
s.72	duty to issue an identity card to each authorised officer	Chief Executive Officer Director – Corporate Development Director - Corporate Services Manager – Governance & Innovation Manager – Governance & Strategy Coordinator – Governance Governance Officer	
s.85	function of receiving report from authorised officer	Chief Executive Officer Director - Engineering & Infrastructure Manager – Community Infrastructure	
s.86	duty to keep register re section 85 matters	Chief Executive Officer Director - Engineering & Infrastructure Manager – Community Infrastructure	
s.87(1)	function of receiving complaints	Chief Executive Officer Director - Engineering & Infrastructure	
s.87(2)	duty to investigate complaint and provide report	Relevant Director	

ROAD MANAGEMENT ACT 2004			
Column 1	Column 2	Column 3	Column 4
PROVISION	THING DELEGATED	DELEGATE	CONDITIONS & LIMITATIONS
s.112(2)	power to recover damages in court	Chief Executive Officer Director - Engineering & Infrastructure Manager - Community Infrastructure	
s.116	power to cause or carry out inspection	Chief Executive Officer Director - Engineering & Infrastructure Manager - Community Infrastructure Coordinator - Project Delivery Team Leader - Asset Preservation	
s.119(2)	function of consulting with VicRoads	Chief Executive Officer Director - Engineering & Infrastructure Manager - Operations Manager - Community Infrastructure Manager - Sustainable Infrastructure	

ROAD MANAGEMENT ACT 2004			
Column 1	Column 2	Column 3	Column 4
PROVISION	THING DELEGATED	DELEGATE	CONDITIONS & LIMITATIONS
s.120(1)	power to exercise road management functions on an arterial road (with the consent of VicRoads)	Chief Executive Officer Director - Engineering & Infrastructure Manager - Operations Manager - Community Infrastructure Coordinator - Works Services Coordinator - Parks Services Coordinator - Construction	
s.120(2)	duty to seek consent of VicRoads to exercise road management functions before exercising power in section 120(1)	Chief Executive Officer Director - Engineering & Infrastructure Manager - Community Infrastructure Manager - Operations	
s.121(1)	power to enter into an agreement in respect of works	Chief Executive Officer Director - Engineering & Infrastructure Manager - Sustainable Infrastructure Manager - Operations Manager - Community Infrastructure	

ROAD MANAGEMENT ACT 2004			
Column 1	Column 2	Column 3	Column 4
PROVISION	THING DELEGATED	DELEGATE	CONDITIONS & LIMITATIONS
s.122(1)	power to charge and recover fees	Chief Executive Officer Director - Engineering & Infrastructure Manager - Community Infrastructure	
s.123(1)	power to charge for any service	Chief Executive Officer Director - Engineering & Infrastructure Manager - Community Infrastructure	
Schedule 2 Clause 2(1)	power to make a decision in respect of controlled access roads	Chief Executive Officer Director - Engineering & Infrastructure Manager - Sustainable Infrastructure Manager - Community Infrastructure Manager - Operations	
Schedule 2 Clause 3(1)	duty to make policy about controlled access roads	Chief Executive Officer Director - Engineering & Infrastructure Manager - Sustainable Infrastructure	

ROAD MANAGEMENT ACT 2004			
Column 1	Column 2	Column 3	Column 4
PROVISION	THING DELEGATED	DELEGATE	CONDITIONS & LIMITATIONS
Schedule 2 Clause 3(2)	power to amend, revoke or substitute policy about controlled access roads	Chief Executive Officer Director - Engineering & Infrastructure Manager - Sustainable Infrastructure	
Schedule 2 Clause 4	function of receiving details of proposal from VicRoads	Chief Executive Officer Director - Engineering & Infrastructure Manager - Sustainable Infrastructure	
Schedule 2 Clause 5	duty to publish notice of declaration	Chief Executive Officer Director - Engineering & Infrastructure Manager - Sustainable Infrastructure	
Schedule 7, Clause 7(1)	duty to give notice to relevant coordinating road authority of proposed installation of non-road infrastructure or related works on a road reserve	Chief Executive Officer Director - Engineering & Infrastructure Manager - Operations Manager - Community Infrastructure Manager - Sustainable Infrastructure	where council is the infrastructure manager or works manager

ROAD MANAGEMENT ACT 2004			
Column 1	Column 2	Column 3	Column 4
PROVISION	THING DELEGATED	DELEGATE	CONDITIONS & LIMITATIONS
Schedule 7, Clause 8(1)	duty to give notice to any other infrastructure manager or works manager responsible for any non-road infrastructure in the area, that could be affected by any proposed installation of infrastructure or related works on a road or road reserve of any road	Chief Executive Officer Director - Engineering & Infrastructure Manager - Operations Manager - Community Infrastructure Manager - Sustainable Infrastructure	where council is the infrastructure manager or works manager
Schedule 7, Clause 9(1)	duty to comply with request for information from a coordinating road authority, an infrastructure manager or a works manager responsible for existing or proposed infrastructure in relation to the location of any non-road infrastructure and technical advice or assistance in conduct of works	Chief Executive Officer Director - Engineering & Infrastructure Manager - Operations Manager - Community Infrastructure Manager - Sustainable Infrastructure	where council is the infrastructure manager or works manager responsible for non-road infrastructure
Schedule 7, Clause 9(2)	duty to give information to another infrastructure manager or works manager where becomes aware any infrastructure or works are not in the location shown on records, appear to be in an unsafe condition or appear to need maintenance	Chief Executive Officer Director - Engineering & Infrastructure Manager - Operations Manager - Community Infrastructure Manager - Sustainable Infrastructure	where council is the infrastructure manager or works manager

ROAD MANAGEMENT ACT 2004			
Column 1	Column 2	Column 3	Column 4
PROVISION	THING DELEGATED	DELEGATE	CONDITIONS & LIMITATIONS
Schedule 7, Clause 10(2)	where Schedule 7 Clause 10(1) applies, duty to, where possible, conduct appropriate consultation with persons likely to be significantly affected	Chief Executive Officer Director - Engineering & Infrastructure Manager - Operations Manager - Community Infrastructure Manager - Sustainable Infrastructure	where council is the infrastructure manager or works manager
Schedule 7 Clause 12(2)	power to direct infrastructure manager or works manager to conduct reinstatement works	Chief Executive Officer Director - Engineering & Infrastructure Manager - Community Infrastructure	where council is the coordinating road authority
Schedule 7 Clause 12(3)	power to take measures to ensure reinstatement works are completed	Chief Executive Officer Director - Engineering & Infrastructure Manager - Community Infrastructure	where council is the coordinating road authority
Schedule 7 Clause 12(4)	duty to ensure that works are conducted by an appropriately qualified person	Chief Executive Officer Director - Engineering & Infrastructure Manager - Community Infrastructure	where council is the coordinating road authority

ROAD MANAGEMENT ACT 2004			
Column 1	Column 2	Column 3	Column 4
PROVISION	THING DELEGATED	DELEGATE	CONDITIONS & LIMITATIONS
Schedule 7 Clause 12(5)	power to recover costs	Chief Executive Officer Director - Engineering & Infrastructure Manager - Community Infrastructure	where council is the coordinating road authority
Schedule 7, Clause 13(1)	duty to notify relevant coordinating road authority within 7 days that works have been completed, subject to Schedule 7, Clause 13(2)	Chief Executive Officer Director - Engineering & Infrastructure Manager - Community Infrastructure	where council is the works manager
Schedule 7 Clause 13(2)	power to vary notice period	Chief Executive Officer Director - Engineering & Infrastructure Manager - Community Infrastructure	where council is the coordinating road authority
Schedule 7, Clause 13(3)	duty to ensure works manager has complied with obligation to give notice under Schedule 7, Clause 13(1)	Chief Executive Officer Director - Engineering & Infrastructure Manager - Community Infrastructure	where council is the infrastructure manager

ROAD MANAGEMENT ACT 2004			
Column 1	Column 2	Column 3	Column 4
PROVISION	THING DELEGATED	DELEGATE	CONDITIONS & LIMITATIONS
Schedule 7 Clause 16(1)	power to consent to proposed works	Chief Executive Officer Director - Engineering & Infrastructure Manager - Operations Manager - Community Infrastructure Manager - Sustainable Infrastructure	where council is the coordinating road authority
Schedule 7 Clause 16(4)	duty to consult	Chief Executive Officer Director - Engineering & Infrastructure Manager - Operations Manager - Community Infrastructure Manager - Sustainable Infrastructure	where council is the coordinating road authority, responsible authority or infrastructure manager
Schedule 7 Clause 16(5)	power to consent to proposed works	Chief Executive Officer Director - Engineering & Infrastructure Manager - Operations Manager - Community Infrastructure Manager - Sustainable Infrastructure	where council is the coordinating road authority

ROAD MANAGEMENT ACT 2004			
Column 1	Column 2	Column 3	Column 4
PROVISION	THING DELEGATED	DELEGATE	CONDITIONS & LIMITATIONS
Schedule 7 Clause 16(6)	power to set reasonable conditions on consent	Chief Executive Officer Director - Engineering & Infrastructure Manager - Operations Manager - Community Infrastructure Manager - Sustainable Infrastructure	where council is the coordinating road authority
Schedule 7 Clause 16(8)	power to include consents and conditions	Chief Executive Officer Director - Engineering & Infrastructure Manager - Operations Manager - Community Infrastructure Manager - Sustainable Infrastructure	where council is the coordinating road authority
Schedule 7 Clause 17(2)	power to refuse to give consent and duty to give reasons for refusal	Chief Executive Officer Director - Engineering & Infrastructure Manager - Operations Manager - Community Infrastructure Manager - Sustainable Infrastructure	where council is the coordinating road authority

ROAD MANAGEMENT ACT 2004			
Column 1	Column 2	Column 3	Column 4
PROVISION	THING DELEGATED	DELEGATE	CONDITIONS & LIMITATIONS
Schedule 7 Clause 18(1)	power to enter into an agreement	Chief Executive Officer Director - Engineering & Infrastructure Manager - Community Infrastructure Manager - Sustainable Infrastructure	where council is the coordinating road authority
Schedule 7 Clause 19(1)	power to give notice requiring rectification of works	Chief Executive Officer Director - Engineering & Infrastructure Manager - Community Infrastructure	where council is the coordinating road authority
Schedule 7 Clause 19(2) & (3)	power to conduct the rectification works or engage a person to conduct the rectification works and power to recover costs incurred	Chief Executive Officer Director - Engineering & Infrastructure Manager - Community Infrastructure	where council is the coordinating road authority
Schedule 7 Clause 20(1)	power to require removal, relocation, replacement or upgrade of existing non-road infrastructure	Chief Executive Officer Director - Engineering & Infrastructure Manager - Community Infrastructure Manager - Sustainable Infrastructure	where council is the coordinating road authority

ROAD MANAGEMENT ACT 2004			
Column 1	Column 2	Column 3	Column 4
PROVISION	THING DELEGATED	DELEGATE	CONDITIONS & LIMITATIONS
Schedule 7A Clause 2	power to cause street lights to be installed on roads	Chief Executive Officer Director - Engineering & Infrastructure Manager - Sustainable Infrastructure	power of responsible road authority where it is the coordinating road authority or responsible road authority in respect of the road
Schedule 7A Clause 3(1)(d)	duty to pay installation and operation costs of street lighting - where road is not an arterial road	Chief Executive Officer Director - Engineering & Infrastructure Manager - Sustainable Infrastructure	where council is the responsible road authority
Schedule 7A Clause 3(1)(e)	duty to pay installation and operation costs of street lighting – where road is a service road on an arterial road and adjacent areas	Chief Executive Officer Director - Engineering & Infrastructure Manager - Sustainable Infrastructure	where council is the responsible road authority
Schedule 7A Clause (3)(1)(f),	duty to pay installation and percentage of operation costs of street lighting – for arterial roads in accordance with clauses 3(2) and 4	Chief Executive Officer Director - Engineering & Infrastructure Manager - Sustainable Infrastructure	duty of council as responsible road authority that installed the light (re: installation costs) and where council is relevant municipal council (re: operating costs)

ROAD MANAGEMENT (GENERAL) REGULATIONS 2016			
Column 1	Column 2	Column 3	Column 4
PROVISION	THING DELEGATED	DELEGATE	CONDITIONS & LIMITATIONS
r.8(1)	duty to conduct reviews of road management plan	Chief Executive Officer Director - Engineering & Infrastructure Manager - Sustainable Infrastructure	
r.9(2)	duty to produce written report of review of road management plan and make report available	Chief Executive Officer Director - Engineering & Infrastructure Manager - Sustainable Infrastructure	
r.9(3)	Duty to give notice where road management review is completed and no amendments will be made (or no amendments for which notice is required)	Chief Executive Officer Director - Engineering & Infrastructure Manager - Sustainable Infrastructure	where council is the coordinating road authority
r.10	duty to give notice of amendment which relates to standard of construction, inspection, maintenance or repair under section 41 of the Act	Chief Executive Officer Director - Engineering & Infrastructure Manager - Sustainable Infrastructure	

ROAD MANAGEMENT (GENERAL) REGULATIONS 2016			
Column 1	Column 2	Column 3	Column 4
PROVISION	THING DELEGATED	DELEGATE	CONDITIONS & LIMITATIONS
r.13(1)	Duty to publish notice of amendments to road management plan	Chief Executive Officer Director - Engineering & Infrastructure Manager - Sustainable Infrastructure	where council is the coordinating road authority
r.13(3)	duty to record on road management plan the substance and date of effect of amendment	Chief Executive Officer Director - Engineering & Infrastructure Manager - Sustainable Infrastructure	
r.16(3)	power to issue permit	Chief Executive Officer Director - Engineering & Infrastructure Manager - Sustainable Infrastructure	where council is the coordinating road authority
r.18(1)	power to give written consent re damage to road	Chief Executive Officer Director - Engineering & Infrastructure Manager - Sustainable Infrastructure	where council is the coordinating road authority

ROAD MANAGEMENT (GENERAL) REGULATIONS 2016			
Column 1	Column 2	Column 3	Column 4
PROVISION	THING DELEGATED	DELEGATE	CONDITIONS & LIMITATIONS
r.23(2)	power to make submission to Tribunal	Chief Executive Officer Director - Engineering & Infrastructure Manager – Community Infrastructure Manager - Sustainable Infrastructure Manager – Operations Director – City Development Manager – City Safety & Health Coordinator – Local Laws Team Leader – Parking Services	where council is the coordinating road authority
r.23(4)	power to charge a fee for application under section 66(1) Road Management Act	Chief Executive Officer Director - Engineering & Infrastructure Manager - Community Infrastructure Coordinator - Project Delivery Director - City Development Manager - City Safety and Health Coordinator - Local Laws Team Leader - Parking Services Team Leader - Asset Preservation Local Laws Officers	where council is the coordinating road authority

ROAD MANAGEMENT (GENERAL) REGULATIONS 2016			
Column 1	Column 2	Column 3	Column 4
PROVISION	THING DELEGATED	DELEGATE	CONDITIONS & LIMITATIONS
r.25(1)	power to remove objects, refuse, rubbish or other material deposited or left on road	Chief Executive Officer Director - Engineering & Infrastructure Manager – Community Infrastructure Manager - Sustainable Infrastructure Manager – Operations Director – City Development Manager – City Safety & Health Coordinator – Local Laws Team Leader – Parking Services	where council is the responsible road authority
r.25(2)	power to sell or dispose of things removed from road or part of road (after first complying with regulation 25(3))	Chief Executive Officer Director - Engineering & Infrastructure Manager – Operations Director – Corporate Development Services Manager – Governance & Innovation Manager – Governance & Strategy Director – City Development Manager – City Safety & Health Coordinator – Local Laws	where council is the responsible road authority

ROAD MANAGEMENT (GENERAL) REGULATIONS 2016			
Column 1	Column 2	Column 3	Column 4
PROVISION	THING DELEGATED	DELEGATE	CONDITIONS & LIMITATIONS
r.25(5)	power to recover in the Magistrates' Court, expenses from person responsible	Chief Executive Officer Director - Engineering & Infrastructure Manager – Operations Director – City Development Manager – City Safety & Health Coordinator – Local Laws	

Official Minutes of Knoxville Council

ROAD MANAGEMENT (WORKS AND INFRASTRUCTURE) REGULATIONS 2015			
Column 1	Column 2	Column 3	Column 4
PROVISION	THING DELEGATED	DELEGATE	CONDITIONS & LIMITATIONS
r.15	power to exempt a person from requirement under clause 13(1) of Schedule 7 of the Act to give notice as to the completion of those works	Chief Executive Officer Director – Engineering & Infrastructure Manager – Community Infrastructure	where council is the coordinating road authority and where consent given under section 63(1) of the Act
r.22(2)	power to waive whole or part of fee in certain circumstances	Chief Executive Officer Director – Engineering & Infrastructure Manager – Community Infrastructure	where council is the coordinating road authority

DOBSON WARD**10.4 NOTICE OF INTENTION TO LEASE – 72 FRANCIS CRESCENT,
FERNTREE GULLY (ILLOURA HOUSE)**

SUMMARY: *Coordinator Property Management (Angela Mitchell)*

This report is presented following the hearing of submissions and on the completion of the statutory process for the lease of 72 Francis Crescent, Ferntree Gully (known as Illoura House).

RECOMMENDATION

That Council, having undertaken the statutory procedures in accordance with the Local Government Act 1989, resolves to:

1. Not enter into a lease with Interchange Outer East for the occupancy of the Council facility at 72 Francis Crescent, Ferntree Gully known as Illoura House having regard to a change in outcomes by Council following the consideration of public submissions.
2. Terminate the Expression of Interest process in respect of the lease of 72 Francis Crescent, Ferntree Gully known as Illoura House.
3. Receive a further report on a new procurement process and associated evaluation criteria to lease 72 Francis Crescent, Ferntree Gully.
4. Advise each of the submitters of Council's decision, the reason for its decision and thank them for their submission.
5. Advise all the organisations who submitted an Expression of Interest to lease 72 Francis Crescent, Ferntree Gully of Council's decision.

1. INTRODUCTION

During August and September 2016, Council undertook a Registration of Interest (ROI) process to test the market for future use of Illoura House (72 Francis Crescent, Ferntree Gully) by Early Childhood Intervention Service (ECIS) and National Disability Insurance Scheme (NDIS) providers.

Following this an Expression of Interest process to lease 72 Francis Crescent, Ferntree Gully for the purpose of operating a disability focussed centre to support children, families, carers and people with disabilities in Knox was conducted. At the closure of the process, four submissions were received.

10.4 Notice of Intention to Lease – 72 Francis Crescent, Ferntree Gully (Illoura House) (cont'd)**2. DISCUSSION**

At the Council meeting on 27 November 2017, Council resolved as follows:

- “1. Following an Expression of Interest process, appoint Interchange Outer East Inc (IOE) as the preferred lessee of the premises at 72 Francis Crescent, Ferntree Gully known as Illoura House.
2. Initiate the processes specified under Section 190 of the Local Government Act 1989 to lease 72 Francis Crescent, Ferntree Gully to IOE and that public notice of the proposed lease be given in the Knox Leader. This proposed lease to include the following conditions:
 - a) The rental will be \$45,000 per annum.
 - b) The term of the lease will be a nine year term.
 - c) The service from this site will provide a disability focussed centre to support children, families, carers and people with disabilities in Knox.
3. Hear submissions in accordance with Section 223(1)(b) of the Local Government Act 1989 and appoint the following Committee of Council comprising Cr Keogh, Cr Mortimore and Cr Pearce to consider submissions on Monday 22 January 2018 at 5.00pm in the Council offices, Knox Civic Centre, 511 Burwood Highway, Wantirna South.
4. Authorise the Chief Executive Officer to carry out the administrative procedures required by Section 223(3) of the Local Government Act 1989.
5. Receive a further report on the outcome and associated recommendations of Section 190 and 223 process.”

At the conclusion of the submission period, two submissions were received with one submission indicating their wish to be heard.

Submitter one outlined the following to the Committee of Council:

- This facility is recognised as an early year’s service provider and should remain as such.
- They indicated that any occupants of this facility should not only provide respite.
- Concerned that there may not be adequate services to children (0-8) with disabilities therefore will result in extensive travel for parents.
- Proposed provider not a registered ECIS provider.

10.4 Notice of Intention to Lease – 72 Francis Crescent, Ferntree Gully (Illoura House) (cont'd)

Submission two outlined the following:

- Concern that preferred provider was not an early childhood intervention provider.
- Council should ensure that tenant be an early childhood intervention provider to maintain the high standards for this age level.

Both submissions are attached as Confidential Appendix A.

The Committee of Council considered the submissions and:

1. Agreed that the tenant at 72 Francis Crescent, Ferntree Gully must be an early year's service provider as well as an NDIS provider.
2. Requested information from officers as to methods to progress '1' above.
3. That a further meeting be reconvened to discuss '1' and '2' above.

The Committee of Council reconvened on Tuesday, 13 March 2018. At this meeting, the Committee received information from officers regarding the appropriate process to ensure that any future lessee at 72 Francis Crescent, Ferntree Gully be both a NDIS and Early Year's provider.

The Committee of Council is now recommending the following:

1. Not enter into a lease with Interchange Outer East for the occupancy of the Council facility at 72 Francis Crescent, Ferntree Gully known as Illoura House having regard to a change in outcomes by Council following the consideration of public submissions.
2. Terminate the Expression of Interest process in respect of the lease of 72 Francis Crescent, Ferntree Gully known as Illoura House.
3. Receive a further report on a new procurement process and associated evaluation criteria to lease 72 Francis Crescent, Ferntree Gully.

3. CONSULTATION

Public notice was given in the Knox Leader on 5 December 2017. At the conclusion of the submission period, two submissions were received with one requesting to be heard in support of their submission. The submissions hearing was held on 22 January 2018 with the Committee of Council reconvening on 13 March 2018.

10.4 Notice of Intention to Lease – 72 Francis Crescent, Ferntree Gully (Illoura House) (cont'd)

4. ENVIRONMENTAL/AMENITY ISSUES

Illoura House is one of 264 community facilities owned by Council on behalf of the Knox community. As described in the Community Facilities Planning Policy, it is important that these facilities be utilised and adapted to meet current and future community need.

The Registration of Interest (ROI) revealed considerable interest from disability service providers to occupy the facility. The EOI that followed the ROI to establish a lease for this purpose returned four high calibre submissions.

5. FINANCIAL & ECONOMIC IMPLICATIONS

Council allocated funds in the 2016/17 financial year to transition out of ECIS and lease Illoura House at a commercial rate. The rental of this facility was set at \$45,000 per annum for a nine year period. A proportion of the rental income will be used to offset resourcing required for Council to manage the tenancy into the future.

6. SOCIAL IMPLICATIONS

The NDIS is a new way of providing individualised support for eligible people with disabilities. It intends to provide an all of life approach for people with disabilities where they can make decisions on the support they need to enable them to participate in their community and achieve their goals. Extending the use of Illoura to NDIS provider/s demonstrates Council's continued support to people with disabilities and the broader Knox community.

7. RELEVANCE TO KNOX COMMUNITY AND COUNCIL PLAN 2017-2021

This report relates to the following goals and strategies within the Knox Community and Council Plan 2017-2021 as outlined below:

Goal 7 We are inclusive, feel a sense of belonging and value our identity
Strategy 7.3 - Strengthen community connections.

Goal 8 We have confidence in decision making
Strategy 8.1 - Build, strengthen and promote good governance practices across government and community organisations.

8. CONFLICT OF INTEREST

Under section 80c of the Local Government Act 1989, officers providing advice to Council must disclose any interests, including the type of interest.

Officer Responsible – (Dale Monk, Manager Business and Financial Services)
- In providing this advice as the Officer Responsible, I have no disclosable interests in this report.

Author – (Angela Mitchell, Coordinator Property Management) - In providing this advice as the Author, I have no disclosable interests in this report

10.4 Notice of Intention to Lease – 72 Francis Crescent, Ferntree Gully (Illoura House) (cont'd)**9. CONCLUSION**

Following the hearing of submissions and the reconvened meeting by the Committee of Council and having undertaken the required statutory procedures, it is recommended to:

1. Not enter into a lease with Interchange Outer East for the occupancy of the Council facility at 72 Francis Crescent, Ferntree Gully known as Illoura House having regard to a change in outcomes by Council following the consideration of public submissions.
2. Terminate the Expression of Interest process in respect of the lease of 72 Francis Crescent, Ferntree Gully known as Illoura House.
3. Receive a further report on a new procurement process and associated evaluation criteria to lease 72 Francis Crescent, Ferntree Gully.

10. CONFIDENTIALITY

The two submissions are attached as Confidential Appendix A.

COUNCIL RESOLUTION

MOVED: CR. KEOGH

SECONDED: CR. PEARCE

That Council, having undertaken the statutory procedures in accordance with the Local Government Act 1989, resolves to:

1. Not enter into a lease with Interchange Outer East for the occupancy of the Council facility at 72 Francis Crescent, Ferntree Gully known as Illoura House having regard to a change in outcomes by Council following the consideration of public submissions.
2. Terminate the Expression of Interest process in respect of the lease of 72 Francis Crescent, Ferntree Gully known as Illoura House.
3. Receive a further report on a new procurement process and associated evaluation criteria to lease 72 Francis Crescent, Ferntree Gully.
4. Advise each of the submitters of Council's decision, the reason for its decision and thank them for their submission.
5. Advise all the organisations who submitted an Expression of Interest to lease 72 Francis Crescent, Ferntree Gully of Council's decision.

CARRIED

10.4 Notice of Intention to Lease – 72 Francis Crescent, Ferntree Gully (Illoura House)

Confidential Appendix A is circulated under separate cover.

Official Minutes of Knox City Council

ALL WARDS**11.1 WORKS REPORT AS AT 2 MARCH 2018**

SUMMARY: *Coordinator – Capital Works (Gene Chiron)*

The Works Report shows projects on Council's Capital Works Program and indicates the status of each project as at 2 March 2018.

RECOMMENDATION

That the works report, as at 2 March 2018, be received and noted.

1. INTRODUCTION

This report summarises Council's Capital Works Program for the 2017/2018 financial year. The aim of this report is to provide a regular and succinct status summary of each project over the last month. The Capital Works Report, as of 2 March 2018, is attached as Appendix A.

Highlights of the Works Report as at 2 March, 2018 include:

- Lewis Park, Wantirna South Oval 1 Renewal - Oval growth is progressing well.
- Suffern Avenue (Waldheim Street) Wetland - Construction works nearing completion.
- Park Crescent, Woodvale Road, Erica Avenue, Boronia, Reconstruction – Contract complete.
- Score Boards - Design and Installation Program – Nearing Completion.
- Alice Johnson Preschool Upgrade - Works Complete.
- Forest Road Ferntree Gully, Shared Path Bridge Renewal Works - Now complete.

COUNCIL RESOLUTION

MOVED: CR. PEARCE

SECONDED: CR. TAYLOR

That the works report, as at 2 March 2018, be received and noted.

CARRIED

Knox City Council Project Status Report

02-Mar-2018

Project Number	Project Name	Total Approved Budget
APPENDIX A		
1	Bridges Renewal Program	\$599,093
All Wards	Forest Road bridge works have been completed. Renewal bridge works at Ferntree Gully Library entrance from Burwood Hwy to follow.	
4	High Risk Road Failures	\$500,000
All Wards	Reactive works to be undertaken to complete this program.	
7	Road Surface Renewal Program	\$4,000,000
All Wards	Program progressing well with 75% of works undertaken and 55 streets completed. Works were on hold during Christmas/January shutdown period.	
8	Drainage Pit and Pipe Renewal Program	\$2,000,000
All Wards	Drainage works have been undertaken at Allanfield Crescent, Wantirna South and Rickards Avenue North, Knoxfield, has recently commenced.	
9	Footpath Renewal Program	\$1,900,000
All Wards	Program progressing on schedule at 80% expended.	
10	Bicycle / Shared Path Renewal Program	\$500,000
All Wards	Shared path adjacent to Underwood Road, Ferntree Gully – scoping works currently being undertaken.	
16	Building Renewal Program	\$6,094,500
All Wards	Program is 46% committed/expended. Works nearing completion/commencing over March include: Knox LeisureWorks stage 2 - male/female change rooms and accessible toilet, structural investigation report and pool plant renewal works, Rowville Community Centre Hall One - timber flooring replacement and associated works, Rosa Benedikt Community Centre - accessible ramp, Orana - external painting, Bellbird Senior Citizen Club - both internal and external painting, State Basketball Centre - air-conditioning renewal works.	
17	Playground Renewal Program	\$1,434,367
All Wards	2017/18 4 of 6 playgrounds are now at Practical Completion. Eildon Reserve playground nearing completion. Balmoral Reserve to start demolition by early March. Knox Playspace Renewal 2017/18 design and documentation is approaching completion. Tender documents to follow.	
22	Fire Hydrant Replacement Program	\$250,000
All Wards	Final Payment to be made in June.	

Knox City Council Project Status Report

02-Mar-2018

Project Number	Project Name	Total Approved Budget
24	Car Park Renewal	\$550,000
All Wards	Scoresby Road shopping centre and Bayswater (Railway Avenue) car park renewal works have been completed.	
25	Plant & Machinery Replacement Program	\$2,985,330
All Wards	Fleet Renewal Program 52% of funding committed.	
26	Street Tree Replacement Program	\$755,000
All Wards	Bulk removals have begun from 26 February to 16 March. Nursery visits completed and stock secured.	
31	Stamford Park Redevelopment	\$9,256,618
Tirhatuan	Homestead – services (sewer, fire, heating/cooling) complete, internal flooring and wall repairs complete, verandah and ramps complete. Awaiting internal painting, accessible toilet and kitchen extension. Works in accordance with heritage conservation report. Homestead Gardens - design almost finalised. Tender works in early March. Parklands - progressing with design works and have commenced planning process.	
43	Shade Sails & Play Structure Maintenance	\$3,193
All Wards	Project completed.	
104	Roadside Furniture Renewal Program	\$100,000
All Wards	Budget 28% expended. Road furniture program focusing on reactive based works referrals. Funding being expended throughout the year as required.	
147	Energy & Greenhouse Program for Council Facilities	\$70,000
All Wards	Scoping completed. Projects will include Energy Efficiency works at Tim Neville Arboretum including efficient fountain pumping schedule and installation of solar cells to control lighting. Lighting improvements and energy monitoring across a number of buildings.	
229	Building Code Australia Compliance	\$100,000
All Wards	Remaining projects to be rolled out between March and June.	
345	Asbestos Removal	\$100,000
All Wards	Bena Angliss Preschool asbestos removal works completed. Remaining projects to be undertaken between March and June.	

Knox City Council Project Status Report

02-Mar-2018

Project Number	Project Name	Total Approved Budget
347	Miscellaneous Industrial Roads - Pavement Rehabilitation	\$250,000
All Wards	Asphalt works to be undertaken shortly at Rocco Drive, Scoresby, and Corporate Avenue, Rowville.	
409	Parks Furniture Renewal	\$50,000
All Wards	Installations ongoing and nearing completion.	
410	Parks Signage Renewal	\$20,000
All Wards	Installations of replacement signs to begin in March.	
412	Water Sensitive Urban Design Renewal	\$326,061
All Wards	Water balance analysis of Waterford Valley Golf Course lake system has been completed. Design of the swales underway.	
441	Tim Neville Arboretum Renewal	\$280,000
Dobson	Consultant has provided refined concept drawings for the gazebo lake structure. Geotech and structural investigations currently being undertaken.	
443	Reserves Paths Renewal	\$60,000
All Wards	Wallace Road Reserve works are now in the final stage.	
459	Dobson Street Reserve Retarding Basin	\$738,692
Friberg	Contract works completed and Practical Completion certificate provided.	
492	Food Act Compliance - Kitchen Retrofitting	\$50,000
All Wards	Projects finalised with works expected to occur over March - April seasonal changeover period.	
494	Cathies Lane - Landfill Rehabilitation Works	\$175,000
Scott	Reinstatement of inadequate capping around gas wells exposed in cells 1 and 2 and also topsoiling of exposed areas of capping and depressions completed in February.	
	<p>Recommendation from consultant's investigations is that there is no current requirement to lower leachate at the site. Investigations underway on stability of embankment near leachate pond. Installed drains at top and toe of embankment and undertaking periodic surveys over twelve months to ascertain if the embankment is moving.</p> <p>Investigation underway to determine if high carbon dioxide levels in landfill gas monitoring bores are from the landfill or other sources. EPA have issued a draft Post Closure Pollution Abatement Notice which will govern the management of the site.</p>	

Knox City Council Project Status Report

02-Mar-2018

Project Number	Project Name	Total Approved Budget
516	Rumann and Benedikt Reserves - Open Space Upgrade	\$176,094
Tirhatuan	Design plans finalised and plans reviewed. Propose to advertise tender from 3 March with tenders closing 27 March.	
536	Parkland Asset Renewal	\$64,000
All Wards	Renewal works continuing throughout March.	
537	Bush Boulevard Renewal	\$30,000
All Wards	Plants ordered for Autumn planting.	
543	Llewellyn Park - Landfill Rehabilitation Works	\$175,000
Scott	Drainage improvements on the site completed in December 2017. Investigation is being undertaken to determine if a landfill gas extraction system is required. This is being done by installing replacement monitoring bores further away from the landfill. The replacement bores were installed in November 2016 and are now being monitored. Work to remove exposed waste in the south west and north west areas of the site was completed in December 2017. Investigation being undertaken on high carbon dioxide readings in monitoring bores to determine if this is from the landfill or background sources.	
566	Artwork Renewal	\$30,463
All Wards	Restoration of the Placemaker Legacy continues. Remaining works are being reviewed in March via a deaccession process (as outlined in the Knox Public Art Implementation Plan). It is expected this budget will be fully spent by end of financial year.	
576	Early Years Facility Emergency Warning System	\$50,000
All Wards	Projects are being scoped and quoted with implementation planned for April holidays. Rowville Preschool has been replaced with higher priority Goodwin Estate to tie in with security gate provision.	
587	Upper Ferntree Gully Neighbourhood Activity Centre - Design	\$472,867
Dobson	Project on hold at Council request.	
589	KEYS - Application Review and Solution Remediation	\$70,000
All Wards	Initial scoping and discussions with business being scheduled.	

Knox City Council Project Status Report

02-Mar-2018

Project Number	Project Name	Total Approved Budget
593	Marie Wallace Reserve - Masterplan Implementation	\$416,876
Dinsdale	(1) Access road carpark - works completed.	
	(2) Pedestrian bridge - survey completed and concept plans prepared following on-site meeting. Works to include renewal of existing shared use pedestrian bridge as well as design of new bridge between ovals. Design & construct documentation to commence in late April.	
607	Ashton Road, FTG - Reconstruction	\$350,000
Friberg	Stage 2 of Ashton Road road works packaged with Stage 2 of Kingston Street. Contractor appointed. Anticipate construction to commence by mid-March.	
608	Kingston Street, FTG - Reconstruction	\$265,000
Friberg	Stage 2 of Kingston Street road works packaged with Stage 2 of Ashton Road. Contractor appointed. Anticipate construction to commence by mid-March.	
630	Early Years Hubs - Bayswater	\$5,925,571
Dinsdale	Contractor has been appointed and works commenced on 19 February.	
649	Scoresby (Exner) Reserve - Masterplan Implementation	\$430,000
Tirhatuan	Scoresby Reserve Carpark - Old tennis courts on low side of access road to be converted to carpark, with existing tennis court lighting to those courts being de-commissioned.	
	Quote is being sought to undertake the carpark works and expect up to a 10 week construction timeframe. Anticipate early March start and late April finish.	
660	Mountain Highway (No. 598), Bayswater Drainage - Design	\$15,015
Dinsdale	Consultant has provided the final detailed design. We are awaiting the final cost estimate.	
664	Stormwater Harvesting Program Development	\$92,961
All Wards	Consultants have been appointed in February to undertake full analysis and functional design solutions for the upgrading of old technology harvesting systems at Eildon Park, Batterham Reserve, Fairpark Reserve and Knox Gardens. Site meetings have been conducted to assess current issues and challenges.	
667	Dobson Creek Catchment - Streetscape Water Sensitive Urban Design	\$186,587
Chandler	Stage 2 - Wicks Road Water Sensitive Urban Design project design is underway. The project is scheduled to be completed by June.	
668	Knox Active Aging Management System (KAAMS)	\$36,266
All Wards	Project completed.	

Knox City Council Project Status Report

02-Mar-2018

Project Number	Project Name	Total Approved Budget
675	Public Art Project	\$160,858
All Wards	<p>Knox's most significant public artwork to date, Aeroplane Boy is due to be installed at Bayswater Station in March/April as part of the Level Crossing Removal works. Other public art projects in the last few months include 'Untitled House' (the mirror house), a partnership with Swinburne University, Cinema Lane light box renewal, Billboard renewal, and mural and other commissions in Council facilities as part of the Immerse program.</p> <p>A scoping document outlining the process, implementation and management of public art at Stamford Park is currently being drafted.</p> <p>A request for quote has been sent to various artists regarding potential artwork commissions at Marie Wallace Reserve.</p>	
689	Lewis Park, Wantirna South Oval 1 Renewal	\$700,000
Dinsdale	Oval growth is progressing well.	
708	Cricket run ups and goal squares	\$44,000
All Wards	Turf grass currently unavailable (Australia wide). Renewal works at remaining reserves will occur when supply of turf grass is obtained.	
710	Colchester Reserve Rugby Pitches	\$17,160
Chandler	Project completed.	
716	Early Years Hubs - Wantirna South	\$13,511,821
Scott	Post tensioned slab works have been completed. Steelwork has commenced.	
717	Knox Central Package	\$8,085,000
Dinsdale	Negotiations to acquire parcels for future road corridor and delivery of Knox Central Masterplan continue, with conclusion expected in this financial year. Residual funding from the Operations Centre land acquisition to remain allocated to the project should additional land be required.	
718	Bulk Replacement of Street Lights with LED	\$500,000
All Wards	Project completed.	
721	Eildon Park Reserve (Pavilion upgrade), Rowville	\$97,600
Taylor	Project completed.	
724	Knox (Interim) Library	\$674,215
Dinsdale	Awaiting confirmed start date from Westfield.	

Knox City Council Project Status Report

02-Mar-2018

Project Number	Project Name	Total Approved Budget
725	Placemakers Site - Design	\$222,263
Dobson	Detailed design has been completed. Cost plan is significantly in excess of budget. Options being worked through to source extra funding/reduce scope prior to tender period. Project is expected to be carried forward.	
727	Knox Community Arts Centre - Outdoor Furniture	\$9,517
Dinsdale	Project completed.	
733	Preschool Office/Storage - Minor Works	\$50,000
All Wards	Works now largely complete and program will be finalised in early March.	
735	Family & Children Services Buildings Door Jamb Protectors	\$25,000
All Wards	Project completed.	
737	Meals on Wheels site reconfiguration - Stage 2	\$50,000
Dinsdale	Strategic review of Meals on Wheels configuration is underway. Plan to be developed over the next six months.	
746	Revegetation Plan	\$100,000
All Wards	Site preparation has been completed. Mulch has been delivered to site and spread. Planting to be completed end of June.	
747	Chandler Park, Boronia - Masterplan Implementation	\$57,128
Chandler	Project completed.	
751	Tim Neville Arboretum - Lake Structure Upgrade	\$141,750
Dobson	Consultant has provided refined concept drawings for Design and Construction of the Lake Structure. Geotech and structural investigations currently being undertaken.	
752	Mountain Gate Shopping Centre Reserve - Design	\$154,425
Friberg	Quote documentation being finalised. Quotes for the works to follow in March.	
755	Talaskia Reserve, Upper Ferntree Gully	\$300,000
Dobson	Reducing scope and re-tender construction works in March.	
757	Carrington Park, Knoxfield - Masterplan	\$88,644
Friberg	Seats have been ordered for installation by Parks team in March.	

Knox City Council Project Status Report

02-Mar-2018

Project Number	Project Name	Total Approved Budget
761	Dandenong Creek Gateways - Strategic Road Corridors Revegetation	\$95,795
All Wards	Open Space team to prepare draft sketch plan for planting works.	
769	Mint Street Wetland System - Stage 2a	\$364,038
Collier	Project completed.	
771	Colchester Road, Boronia – Wetland and Raingarden	\$40,000
Chandler	Project completed.	
773	Suffern Avenue (Waldheim Street) Wetland	\$368,345
Dinsdale	Construction works nearing completion with works expected to be completed by end of February/early March 2018.	
785	Printer Upgrade	\$43,000
All Wards	Project completed.	
786	Microsoft Office 365	\$200,000
All Wards	All Council directorates migrated to MS Exchange (cloud) and Office 365. Councillors and CEO to be migrated in March.	
787	Website Redevelopment	\$436,000
All Wards	Initial planning has commenced with the objective of selecting an Implementation Partner by end of June.	
788	Network Drive Migration	\$225,000
All Wards	Project completed.	
789	Facilities Booking Review/Upgrade	\$71,300
All Wards	Project on hold until software release available from Priava.	
791	Computer Lease	\$120,000
All Wards	Leased software and hardware expenses are incurred throughout the year.	
792	PC/Device Rollout Lease	\$280,000
All Wards	Leased software and hardware expenses are incurred throughout the year.	

Knox City Council Project Status Report

02-Mar-2018

Project Number	Project Name	Total Approved Budget
793	Non Leased Software and Hardware	\$120,000
All Wards	Leased software and hardware expenses are incurred throughout the year.	
794	Switch Replacement Program (Leased)	\$250,000
All Wards	Leased software and hardware expenses are incurred throughout the year.	
796	Park Crescent, Boronia - Reconstruction	\$383,040
Baird	Project completed.	
798	Woodvale Road, Boronia - Reconstruction	\$114,240
Baird	Project completed.	
799	Windermere Drive, Ferntree Gully - Reconstruction	\$305,446
Friberg	Project packaged with Smithfield Square project. Contract works in Windermere Drive completed with practical completion inspection planned for 23 February. Plateau speed hump modification completed.	
800	Smithfield Square, Wantirna - Reconstruction	\$281,205
Collier	Construction completed with practical completion inspection imminent.	
801	Sasses Avenue, Bayswater - Reconstruction	\$344,202
Dinsdale	Contract works completed.	
802	Erica Avenue, Boronia - Reconstruction	\$70,725
Baird	Project completed.	
803	Macquarie Place, Boronia - Reconstruction	\$270,289
Chandler	Contract works completed. Practical completion inspection to be arranged with contractor.	
804	Dorset Road (169), Boronia - Flood Mitigation	\$97,000
Baird	Project completed.	
806	Cash Fues Place Wetland System - Design	\$60,765
Collier	Works to commence by early March.	

Knox City Council Project Status Report

02-Mar-2018

Project Number	Project Name	Total Approved Budget
809	Bayswater Activity Centre Streetscape Improvements	\$1,620,411
Dinsdale	Footpath and landscaping works are nearing completion. There are some minor rehabilitation works to be completed. VicRoads has issued a contract for all the works associated with the undergrounding of the powerlines. The electrical contractor has commenced preliminary works on site. It is anticipated that power undergrounding works may take 4-5 months.	
812	Asset Management System	\$20,000
All Wards	Project planned to commence in March.	
813	Information architecture design and planning	\$280,000
All Wards	Cumulative extracts built for Asset Management (LifeCycle, ProjectsPro, additions for IT Service Management and Corporate Reporting (Interplan)).	
814	Standard Operating Environment Upgrade	\$130,336
All Wards	New devices being rolled out with the new Standard Operating System.	
815	Pathway Smartclient implementation	\$90,000
All Wards	Ongoing training being delivered. Additional vendor resource being scheduled to facilitate refresher training.	
816	ePathway Payment enhancements/extension	\$80,000
All Wards	Additional online payment options created in line with new application types published online.	
817	WAN Network Enhancements	\$50,000
All Wards	Project completed.	
818	DRP Update and full test	\$141,360
All Wards	Disaster recovery resources have been moved to NextDC a purpose built DR centre (Port Melbourne). Full DR test planned for March.	
819	IT Security Audit (policies & procedures)	\$50,000
All Wards	Penetration testing rescheduled for March.	
820	Mobile phone refresh (iPhone)	\$20,000
All Wards	Replacement program in progress.	

Knox City Council Project Status Report

02-Mar-2018

Project Number	Project Name	Total Approved Budget
821	Storage	\$60,000
All Wards	Project completed.	
822	Security, Email Filtering and Firewall	\$57,581
All Wards	Scheduled to commence in April.	
823	DC1 - Server Room AC & UPS	\$100,000
All Wards	Waiting on residual activities to be completed before releasing final payment.	
825	Microsoft Licensing (True Up)	\$150,000
All Wards	True-up scheduled to commence in April/May.	
826	Microsoft SQL Licence	\$220,000
All Wards	Expenses are incurred throughout the year as required.	
827	Intranet Update (2018/9)	\$615,000
All Wards	Project to be undertaken in 2018/19.	
829	Knox Community Art Centre, Bayswater	\$10,000
Dinsdale	Project completed.	
830	Park Ridge Reserve, Rowville - Oval Renewal	\$56,500
Taylor	Club is back training at venue, grass coverage is nearly 100%.	
831	Templeton Reserve, Wantirna - Oval Renewal	\$38,000
Collier	Club is back at venue, grass coverage is nearly 100%.	
832	Knox Gardens Reserve, Wantirna South - Oval 2 Renewal	\$14,788
Scott	Club is back at venue. Grass is nearly at 95% coverage.	
833	Knox Gardens Reserve, Wantirna South - Tennis Court Renewal	\$294,000
Scott	Leisure and club consulted on design. Design and documentation completed and plan to tender from 3 March with tenders closing 27 March.	

Knox City Council Project Status Report

02-Mar-2018

Project Number	Project Name	Total Approved Budget
834	Oversowing of Sports Fields	\$30,000
All Wards	Seed has been selected and purchased.	
837	Westfield (Permanent) Library - Design	\$200,000
Dinsdale	Awaiting outcomes of discussions with Westfield.	
838	Bayswater Community Hub - Scoping	\$120,000
Dinsdale	Council officers engaging with the broader community on what their current service delivery needs are/gap analysis in the Bayswater area. Issues Briefing report going to Council in March to discuss potential purchase of land.	
839	Preschool Bathroom Upgrades - Bena Angliss Preschool	\$222,000
All Wards	Construction onsite has commenced and is tracking as scheduled. Works will be completed for handover by mid-March.	
842	Knox Athletics - Hammer Throw Cage Upgrade	\$56,549
Friberg	Detailed design finalised. Club have offered additional funding and have asked Council to fund remainder for preferred design. Additional funding approved. To be packaged with discus cage once design completed. Athletics Club have requested construction be delayed until the period 6 June to 20 July.	
844	Score Boards - Design and Installation	\$390,000
All Wards	Project list has been finalised and approved. Approved projects have been commenced and all projects expected to be completed by June.	
845	Carrington Park Leisure Centre - Basketball Rings	\$35,000
Friberg	Project completed.	
846	Knox Gardens Reserve - Lower Oval Shelters	\$39,015
Scott	Project completed.	
847	Boronia Basketball Stadium - Safety Padding	\$36,000
Baird	Project completed.	
849	Repurposing Scoping of Facilities from Hub Projects.	\$93,550
All Wards	Scoping the future use of Family and Children's Services Child Care Centres is tracking late with low impact due to other early years priorities. Once scoping is complete, information will go to Council for further advice.	

Knox City Council Project Status Report

02-Mar-2018

Project Number	Project Name	Total Approved Budget
851	Senior Citizens Centres - Facilities Development Plan	\$60,000
All Wards	The consultants have been delayed. We are still waiting on the final report as there was a delay in the consultant receiving costing information to finalise the report.	
853	Aimee Seebeck Hall, Amenities Design	\$20,000
Taylor	Project completed.	
854	Knox Community Gardens/Vineyard Pergola Upgrade	\$10,000
Dinsdale	Knox Community Gardens Group informed Council officers that the upgrade to the pergola is no longer required.	
860	Bergins Road, Rowville - Fowler Road to Kalimna Court	\$125,000
Taylor	Project completed.	
862	Burwood Highway Shared Path - Traydal Close to Knox School	\$137,900
Collier	Pine trees have been removed. Preparing application to VicRoads to approve construction works along Burwood Hwy.	
866	Ferntree Gully Village Square - Masterplan Implementation	\$183,585
Dobson	On hold. Design subject to future development plans at the site, following Council purchase of adjoining land.	
867	Knox Regional Netball Centre, Ferntree Gully - Masterplan	\$131,872
Dobson	Consultants currently updating Feasibility Study in regard to the next steps in the development of the Masterplan, including additional information as requested by Council.	
868	H V Jones, Ferntree Gully Masterplan Implementation	\$143,000
Friberg	Consultants to refine initial draft masterplan, following comments from Council officers.	
869	Gilbert Park, Knoxfield - Masterplan Review	\$177,000
Friberg	Draft masterplan is being updated with minor edits as required. Officers to consult with the club on the proposed changes.	
871	Energy Performance Audit for Community Buildings	\$418,636
All Wards	Detailed facility study covering all energy saving opportunities will be delivered for user group consultation by early March.	

Knox City Council Project Status Report

02-Mar-2018

Project Number	Project Name	Total Approved Budget
874	Fulham Road, Rowville Reconstruction	\$125,000
Tirhatuan	Design completed and review imminent. Consultation with Stud Park Centre Management and retirement village has occurred. Plan to tender project from mid-March with construction planned from mid-late April, to enable use of overlapping funds so as to complete works as one continuous contract package in July.	
875	Parkhurst Drive, Knoxfield Reconstruction	\$120,000
Dinsdale	Detailed design nearing completion with design review to follow. It is proposed to defer the funding for this project to next financial year and package with the remaining two (2) stages as one tender. Construction planned for March 2019 to enable use of overlapping funds so as to complete total necessary works as one contract early in 2019/20.	
876	Eastgate Court, Wantirna South Reconstruction	\$295,000
Dinsdale	Contract advertised with tenders having closed on 6 February. Contractor appointed with construction likely to commence from mid-March.	
877	Rosehill Street, Scoresby Reconstruction	\$530,000
Tirhatuan	Contractor appointed and possession of site to be provided on approval of contract documentation. Commencement of construction works delayed with works now anticipated to commence around after Easter and be completed by June.	
878	Alma Avenue, Ferntree Gully Reconstruction	\$330,000
Dobson	Contract packaged with Winwood Drive and Helene Court projects. Contract works completed in Helene Court and works now well underway with Winwood Drive. This is to be followed up by Alma Avenue works which are anticipated to be completed by around May.	
879	Winwood Drive, Ferntree Gully Reconstruction	\$398,000
Dobson	Contract packaged with Alma Avenue and Helene Court projects. Contract works completed in Helene Court and works now well underway with Winwood Drive with kerb & channel on south side completed and footpath works around 70% complete. This is to be followed up by Alma Avenue works.	
880	Helene Court, Boronia Reconstruction	\$337,000
Chandler	Contract packaged with Winwood Drive and Alma Avenue projects. Contract works completed in Helene Court with Winwood Drive well underway and Alma Avenue works to follow around April.	
884	Glenfern Road Footpath - Burwood Highway to Brenock Park Drive	\$36,961
Dobson	Project completed.	

Knox City Council Project Status Report

02-Mar-2018

Project Number	Project Name	Total Approved Budget
886	Schultz Reserve - Internal Pavilion Upgrades (Female Friendly)	\$100,000
Collier	Tender has closed. Submissions are currently being assessed with view to have a contractor appointed in mid-March.	
888	Batterham Reserve Floodlighting Upgrade	\$200,000
Chandler	Contractor appointed and works have commenced with completion expected mid to late April.	
889	Wally Tew Reserve Floodlighting Upgrade	\$200,000
Dobson	Foundations and boring all now completed.	
891	Henderson Road Bridge - Preconstruction	\$545,900
Friberg	Concept design is being discussed with Melbourne Water to seek in principal agreement prior to undertaking further design work.	
907	JW Manson Reserve WSUD - Construction	\$240,793
Collier	Council is currently under negotiations with VicRoads for the purchase of the easement. The high cost implications to Council could signify that additional funding would be required to continue with the project. Funding may be available from Melbourne Water through the Enhancing of Dandenong Creek Program.	
923	679 Boronia Road - Service Road, Wantirna - Reconstruction	\$10,000
Collier	Project deferred indefinitely to allow for scoping and complex title investigations.	
924	Cherrington Square, Wantirna - Design	\$15,000
Collier	Survey planned for early March.	
925	1101 Burwood Hwy, Ferntree Gully - Design	\$5,000
Dobson	Survey, design and estimate completed.	
926	Windermere Drive, Ferntree Gully - Design	\$25,000
Friberg	Detailed design approximately 60% complete.	
927	Selman Avenue, Ferntree Gully - Design	\$30,000
Dobson	Geotech investigation and survey completed and design nearing completion with design review to follow.	

Knox City Council Project Status Report

02-Mar-2018

Project Number	Project Name	Total Approved Budget
928	Barmah Drive, Wantirna - Design	\$5,000
Collier	Geotech investigation completed. Survey is completed and design is underway.	
929	Albert Avenue, Boronia - Design	\$55,000
Chandler	Geotechnical report and survey completed with design 95% complete and design review to follow.	
930	Forest Road, Ferntree Gully - Design	\$40,000
Dobson	Survey completed and detailed design about to commence.	
931	Underwood Road, Ferntree Gully - Design	\$30,000
Dobson	Design completed.	
932	Burwood Highway - service road, Ferntree Gully - Design (1)	\$10,000
Dobson	Geotech investigation and survey completed.	
933	Burwood Highway - service road, Ferntree Gully - Design (2)	\$5,000
Dobson	Geotech work completed and plan to survey site in March.	
934	Sheraton Cres, Ferntree Gully - Design	\$20,000
Friberg	Geotech work completed and plan to survey site in March.	
935	Scoresby (Exner) Reserve - Tennis Court Renewals	\$250,000
Tirhatuan	Contractor appointed and works delayed and timed to commence once proposed Masterplan carpark works are close to completion. Anticipate construction to commence in April.	
936	Carrington Park Reserve - Tennis Court Renewals	\$155,000
Friberg	Survey completed and design underway. Quotes to be called over March to replace synthetic surface.	
937	Kings Park Baseball Diamond - Safety Fencing	\$60,000
Dobson	Works have been on hold since November. Club is still considering the appropriate design for cages.	
938	Kings Park Reserve - Drainage Renewal Works Oval #1	\$150,000
Dobson	Works completed.	

Knox City Council Project Status Report

02-Mar-2018

Project Number	Project Name	Total Approved Budget
939	Millers Reserve - Oval Renewal - Design	\$15,000
Chandler	Contractors have commenced design drawings.	
940	Wally Tew Reserve - Cricket net renewals - Design	\$10,000
Dobson	Survey planned for March with detailed design to follow.	
941	Knox Regional Netball Centre - Court Renewals	\$20,000
Dobson	Extensive internal consultation undertaken. Sports surface consultant has completed pavement detailed design with treatment required. Estimate, design & documentation will be submitted soon to allow business case to be established by Parks for construction funding.	
942	Tree Management	\$100,000
All Wards	Works to be carried out as required.	
943	Early Years Security Keypads	\$30,000
All Wards	Projects currently being scoped and quoted. Implementation is expected during the April school holidays.	
944	Knox Central (Operations Centre Relocation)	\$500,000
Dinsdale	Design development works are progressing. Aiming for detailed design completion July 2018. Remediation and assessment works (relating to contaminated soil at current Centre) have commenced in conjunction with an independent environmental auditor.	
945	ICT - Website Redevelopment (Part of Project 787)	\$824,500
All Wards	Initial planning commenced with objective of selecting preferred implementation partner by end of June.	
946	Boronia Precinct Planning	\$390,000
Baird	A preliminary Key Directions report has been prepared based on data collected to date. A summary of the community engagement, including feedback received from 4 community workshops, survey and several consultation events as well as social media in Stage 1 will be presented to Council at Issues Briefing. The Issues Briefing report includes all the technical background reports. Stage 1 is on track to be reported to Council in March.	
947	Knox Skate & BMX Park - New Youth Pavilion	\$75,000
Friberg	Concept design and cost plan will be prepared for 2018/2019 SRV application. Project scheduled to commence in April.	

Knox City Council Project Status Report

02-Mar-2018

Project Number	Project Name	Total Approved Budget
948	Alternative Buildings Program (Pavilions)	\$550,000
All Wards	Batterham and Knox Gardens have proceeded to re-tender with submissions to be provided by early March.	
949	The Basin Neighbourhood House Redevelopment at The Basin Primary School	\$2,500,000
Chandler	Progressed establishing an agreed list of fittings, furniture and equipment with a view to finalise by end of June.	
950	Family & Childrens Services Buildings & Facilities	\$270,000
All Wards	Alice Johnson Preschool Bathroom upgrade works are complete.	
951	Community Toilet Replacement Program	\$220,000
All Wards	Tender submissions currently being assessed with view to have contractor appointed by mid-March.	
952	HV Jones Reserve Floodlighting Upgrade	\$250,000
Friberg	Contractor appointed and works have commenced. Power upgrade works (and associated cabling/panel upgrades) have also been commissioned.	
953	Schultz Reserve - New Floodlighting	\$150,000
Collier	Quotes have been received and are currently being assessed with view to appoint contractor by mid-March.	
954	Knox BMX Track - New Storage & Start Gate Structure	\$200,000
Friberg	The proposed designs are being revised to reduce the scope of works. The initial cost estimates are higher than the allocated funds. The revised documentation will be completed by early March.	
955	Gilbert Park Skate Park Lighting	\$25,000
Friberg	Project completed.	
956	Knox Athletics Track - Discus Cage Upgrade	\$75,000
Friberg	Survey completed and design underway. Intend packaging this project with the Knox Athletics hammer-throw cage project after Easter. Athletics Club have requested construction be delayed until the period 6 June to 20 July.	
957	Kings Park - New Floodlighting (Oval 2) - Design	\$2,000
Dobson	Project completed.	

Knox City Council Project Status Report

02-Mar-2018

Project Number	Project Name	Total Approved Budget
958	Liberty Avenue Reserve - New Floodlighting - Design	\$2,000
Taylor	Project completed.	
959	Rowville Community Centre - Lighting Upgrade	\$50,000
Taylor	Project currently being quoted with contractor to be appointed by early March.	
960	Knox Regional Netball Centre Improvements to Outdoor Amenities	\$150,000
Dobson	Contractor has commenced with works expected to be completed by mid-March.	
961	Knox Regional Netball Centre Floodlight Outdoor Courts 5 to 8	\$200,000
Dobson	The project is on hold. Waiting for revised masterplan from Leisure Services and Open Space & Landscape team.	
962	Knox Regional Sports Park Signage	\$130,000
Scott	Concept design is completed. New location has been confirmed. Awaiting authority consent and update to concept design to proceed to request for quotation.	
963	Family & Children Services - Site Master Plans - Stages 1 & 2	\$50,000
All Wards	Remaining feature site plans to be completed by end of April.	
964	Relocate Preschool Bag Lockers	\$32,000
All Wards	Mariemont Preschool has been completed. Remaining works to be undertaken over the April school holidays.	
965	Billoo Park Preschool - Toilet and Storage Upgrade Design	\$10,000
Collier	Project to be placed on hold until the childcare has relocated to the new Hub and then revisit the facility to scope works.	
966	Alexander Magit Preschool - Verandah Replacement Design	\$10,000
Friberg	Concept design has commenced with an expected completion by end of March.	
967	Goodwin Estate Preschool - Verandah Replacement Design	\$10,000
Chandler	Concept design has commenced with an expected completion by end of March.	
968	Flamingo Preschool - Verandah Replacement Design	\$10,000
Collier	Concept design completed.	

Knox City Council Project Status Report

02-Mar-2018

Project Number	Project Name	Total Approved Budget
969	Orana Neighbourhood House Kitchen Upgrade	\$5,000
Dinsdale	Project has proceeded to design phase. Design completion expected by early March.	
970	Bayswater Scout Hall at Marie Wallace	\$150,000
Dinsdale	Awaiting scoping/funding information.	
971	Mountain Highway, The Basin Footpath (Basin Primary School)	\$10,000
Chandler	Works completed.	
972	Mountain Highway, The Basin Footpath (Dorrigo Drive)	\$40,000
Chandler	Project completed.	
973	Mountain Highway, The Basin Footpath (Wicks Road and Basin Shops)	\$340,000
Chandler	Contractor appointed and awaiting pre-construction documentation to be submitted and approved. Construction works now anticipated to commence by mid-March.	
974	Bergins Road right turn lane	\$150,000
Taylor	Contract works now well underway with works approximately 25% complete.	
975	Function Rooms - Audio Upgrade	\$150,000
All Wards	Upgrades to Meeting Rooms 1 & 2 on track.	
976	HR System Enhancements	\$117,400
All Wards	Business case development continuing.	
977	Pathway Online Applications / Permits / Registrations	\$127,000
All Wards	Number of application types are ready for deployment, awaiting business readiness. Scoping Underway.	
978	Microsoft Exchange Upgrade	\$50,000
All Wards	Project completed.	
979	GIS Phase 3	\$200,000
All Wards	3D GIS development underway. Preparing scope/RFQ for VicMap data migration project expected to commence in April to June.	

Knox City Council Project Status Report

02-Mar-2018

Project Number	Project Name	Total Approved Budget
981	Applications Support - Mobile Computing & Information Integrity (EFT) (2018/9)	\$90,000
All Wards	Project to be undertaken in 2018/19.	
982	Anne Road, Knoxfield LATM	\$10,000
Friberg	Preparing initial consultation letter.	
983	Stewart Street LATM	\$90,000
Chandler	First draft of design plans for traffic devices received from consultant for comment.	
984	Napoleon Road, Lysterfield Shared Path	\$200,000
Taylor	The consultant is in the process of providing a detailed survey and design for VicRoads' approval.	
985	Napoleon Road, Lysterfield, Shared Path 4 - Design	\$10,000
Taylor	Survey completed and concept plan prepared and submitted for consideration. Detailed design underway.	
986	Boronia Road Activity Centre Bike Parking	\$1,500
Baird	Materials have been received. Bike hoops scheduled for installation in March.	
987	Wayfinding Signage for Cyclists	\$5,000
All Wards	Installation plans completed. Seeking estimate for construction works.	
988	Marie Wallace Bicycle Repair Station	\$3,000
Dinsdale	Project completed.	
989	George Street, Scoresby Bicycle Improvements	\$139,000
Scott	Stage 1 between Zarro Street and Berrabri Drive was completed. Waiting on VicRoads to approve Stage 2 construction works.	
990	Tyner Rd, Wantirna South New School Crossing	\$28,000
Scott	Project completed.	
991	Wellington Road, Rowville Footpath Connection	\$40,000
Tirhatuan	Construction programmed for March.	

Knox City Council Project Status Report

02-Mar-2018

Project Number	Project Name	Total Approved Budget
992	Karoo Rd, Rowville Footpath Connection	\$25,000
Friberg	Project completed.	
993	Ferntree Gully Road, Scoresby Footpath Connection	\$10,000
Tirhatuan	Feature survey completed and licensed surveyor has confirmed title boundary. Design underway.	
994	Picketts Reserve, Ferntree Gully Masterplan Implementation	\$100,000
Baird	All works completed except for some of the line marking, which is expected to occur shortly.	
995	Peregrine Reserve, Rowville - Masterplan	\$45,000
Taylor	The draft masterplan is currently in community consultation phase, seeking feedback prior to developing the final issue. A copy of the draft masterplan is located at the reserve and posted on Council's social media.	
996	Arcadia Reserve, Rowville - Masterplan	\$100,000
Tirhatuan	Contractors have been engaged. Works scheduled to commence in early March.	
997	Llewellyn Reserve, Wantirna South - Masterplan	\$100,000
Scott	Indigenous planting to disturbed area north of site, embankment planting and entry planting to commence in Autumn. Entry signage to be developed for Llewellyn Park Drive and Helpmann Street.	
998	Templeton Reserve, Wantirna - Masterplan	\$170,000
Collier	Area adjacent to cricket club pavilion essentially completed late January with remainder of works approaching tennis club completed by 16 February. Completion of contract works delayed due to additional works request by club. Additional funds to be sought by Leisure.	
999	Lewis Park, Wantirna South - Masterplan	\$200,000
Dinsdale	Internal Council officer consultation to commence in late February. Project team to meet with Melbourne Water in late February and other stakeholders in March.	
1000	Stud Park Reserve, Rowville - Masterplan	\$40,000
Tirhatuan	Detailed design and documentation scheduled to commence in March.	
1001	Scoresby Village Reserve - Masterplan	\$20,000
Tirhatuan	Design stage scheduled to commence in March.	

Knox City Council Project Status Report

02-Mar-2018

Project Number	Project Name	Total Approved Budget
1002	RD Egan Lee Reserve, Knoxfield	\$45,000
Scott	The draft masterplan has been submitted to Council for review.	
1003	Wantirna Reserve - Masterplan	\$50,000
Collier	Draft masterplan supplied for initial officer comment. Consultant to refine and resubmit draft masterplan for consultation in March.	
1004	Knox Park, Knoxfield - Relocation of Playground	\$20,000
Friberg	Project completed.	
1005	Neighbourhood Green Streets	\$50,000
All Wards	Open Space to prepare sketch plans for planting.	
1006	Bush Boulevards	\$50,000
All Wards	Open Space to prepare sketch plans for planting including rocks, logs to restrict parking where required.	
1007	Upper Blind Creek (Catchment 910) Scale Feasibility	\$50,000
Dobson	A consultant has been hired to look at the flood mitigation impact of the proposed project on Catchment 910. The result will be completed by early March. The results will guide the design of this project. Design to commence in March.	
1008	Mont Albert to Forest Roads - Drainage improvements	\$20,000
Dobson	A consultant has been hired to look at the flood mitigation impact of the proposed project on Catchment 910. The result will be completed by early March. Should the results produce a beneficial outcome for the community, consultation with the relevant stakeholders will be undertaken to address the issue of funding for the design and construction of the project.	
1009	Talking Tanks Initiative - Flood Protection	\$30,000
All Wards	Initial feasibility modelling looked at two catchments; applied a 3 tanks per property scenario; with a 30% uptake. Results were less than favourable using private land solely. A variation to the project scope was agreed (late December) to investigate below ground storages to contain excess flood volumes (combination of above and below ground solutions). A desktop analysis is currently underway and if results are positive, these will be applied to solution options going forward.	

Knox City Council Project Status Report

02-Mar-2018

Project Number	Project Name	Total Approved Budget
1010	Dam Condition Audit & Concept Design Solutions	\$50,000
All Wards	An internal review found that the additional retarding basins within the municipality do not meet the ANCOLD definition of a large dam and thus no dam condition audits are required at these sites.	
1011	The Basin Triangle Public Toilet - Installation of Change Table	\$3,500
Dobson	Project completed.	
1013	Marie Wallace Bayswater Solar Panel Installation	\$40,910
Dinsdale	Project completed.	
1014	Batterham Reserve Solar Panel Installation	\$9,091
Chandler	Project completed.	
1015	Tormore Reserve Solar Panel Installation	\$40,910
Baird	Project completed.	
1016	Kings Park Solar Panel Installation	\$9,091
Dobson	Awaiting on the club to complete verandah project. Solar panel works will commence afterwards.	
1024	ICT - Information architecture design and planning (Part of Project 813) (2018/9)	\$150,000
All Wards	Project to be undertaken in 2018/19.	
1025	ICT - Pathway Smartclient implementation (Part of Project 815)	\$100,000
All Wards	Funds transferred to project 815.	
1026	ICT - DRP Update and full test (Part of Project 818)	\$140,000
All Wards	KCC DR resources have been relocated to NextDC Disaster Recovery Centre, local DR capabilities at EastGate North have been decommissioned. Full DR test to occur in February.	
1027	ICT - Agenda & Minutes Management (Phase 2 - delegations/authorisations)	\$80,000
All Wards	ICT/Digital Strategy funding approval given.	
1028	ICT - Microsoft Sharepoint Upgrade (Part of Project 827) (2018/9)	\$415,000
All Wards	Project to be undertaken in 2018/19.	

Knox City Council Project Status Report

02-Mar-2018

Project Number	Project Name	Total Approved Budget
1029	ICT - iChris - Chris21 upgrade (Part of Project 976) All Wards Project scheduled to commence in March.	\$50,000
1030	ICT - Microsoft Exchange Upgrade (Part of Project 978) All Wards Project completed.	\$100,000
1031	ICT - Data Integration - Spatial (2018/9) All Wards Project to be undertaken in 2018/19.	\$70,000
1032	ICT - CRM Citizen Portal for Web All Wards Funding approval given for project to commence.	\$65,000
1033	ICT - CMS Integration and Portal (2018/9) All Wards Project to be undertaken in 2018/19.	\$160,000
1034	ICT - CRM Pilot, Enterprise Solution All Wards Awaiting ICT/Digital Strategy funding approval.	\$1,100,000
1035	ICT - Payment Gateway All Wards Awaiting ICT/Digital Strategy funding approval.	\$150,000
1036	ICT - HR System Enhancements All Wards Process mapping underway with 'roadmap' of work packages due early March.	\$300,000
1037	ICT - Key Project Initiation Documentation All Wards Initiation document delivered by Pario.	\$145,500
1038	ICT - Business Strategy and Benefits Identification All Wards Benefits report has been delivered and reviewed.	\$75,000
1039	ICT - IT Network Security Evaluation and Upgrade (2018/9) All Wards Project to be undertaken in 2018/19.	\$554,000
1040	Dandenong Creek Amenity Improvements All Wards Site maps for quoting purposes are currently being prepared. Works to be implemented following Melbourne Water daylighting of Dandenong Creek.	\$70,800

Knox City Council Project Status Report

02-Mar-2018

Project Number	Project Name	Total Approved Budget
1041	11 Nathan Street, Ferntree Gully - Flood Mitigation	\$97,000
Dobson	The draft detailed design has been completed and is currently being reviewed with the Project Delivery team.	
1045	Egan Lee Reserve - Internal Pavilion Upgrades (Female Friendly)	\$3,000
Scott	SRV application has been submitted and waiting for the funding outcome.	
1046	Scoresby Recreation Reserve - Pavilion Lift Installation	\$70,000
Tirhatuan	Project completed.	
1047	Colchester Reserve Safety Fencing	\$5,800
Chandler	Project completed.	
1052	Coonara House Solar Panels	\$13,636
Dobson	Project completed.	
1053	Eildon Park - New Shade Structure	\$10,000
	Construction complete. Awaiting internal transfer of funds to finalise project.	
1054	Knox Regional Sports Park - Masterplan	\$150,000
Scott	Additional stakeholder information is being collated and another masterplan option prepared to be considered by Council at the April Council meeting.	
1063	Sasses Reserve Safety Fencing	\$15,500
Dinsdale	Works have commenced. Project set to be completed by early March.	
1068	Rowville Recreation Reserve - Multipurpose Community Workshop	\$350,000
Taylor	The feature survey of the proposed site completed to assist with the sketch concept development of the multipurpose community workshop. Site analysis and investigation undertaken to investigate feasibility of all the required services for the community workshop space.	
	Total:	\$95,794,463

ALL WARDS**11.2 ASSEMBLIES OF COUNCILLORS**

SUMMARY: *Governance Advisor (Rodney McKail)*

This report provides details of Assembly of Councillors established under section 80A of the Local Government Act as required under section 80A(2) of the Act.

RECOMMENDATION

That Council

1. Note the written record of Assemblies of Councillors as attached to this report.
2. Incorporate the records of the Assemblies into the minutes of the meeting.

1. INTRODUCTION

Under section 80A(2) of the Local Government Act, the Chief Executive Officer must present a written record of an Assembly of Councillors to an ordinary meeting of Council as soon as practicable after an Assembly occurs. This written record is required to be incorporated into the minutes of the meeting.

Details of Assemblies of Councillors that have occurred up to Sunday 11 March 2018 are attached to this report.

COUNCIL RESOLUTION

MOVED: CR. PEARCE
SECONDED: CR. TAYLOR

That Council

1. Note the written record of Assemblies of Councillors as attached to this report.
2. Incorporate the records of the Assemblies into the minutes of the meeting.

CARRIED



Record of Assembly of Councillors

(Section 80A Local Government Act)

Complete this Section

Date of Assembly: 13/12/2017

Name of Committee or Group (if applicable): Knox Arts & Culture Advisory Committee

Time Meeting Commenced: 6.30pm

Name of Councillors Attending:

Cr Peter Lockwood

Cr Jackson Taylor

Name of Members of Council Staff Attending:

Peter Gore

Elissa Pachacz

Jenny Gay

Matters Considered:

1. Creative Victoria Funding Update: Knox Amplify 2018
2. Inside Story: Cultural Venues Program 2018
3. Project in Focus: Knox Factor
4. Arts Presentation: SLAMS Musical Theatre Inc

Any conflict of interest disclosures made by a Councillor attending: *Nil

Name	Disclosure (refer front of form)	Relevant Matter	Left Assembly **
			Yes/No
			Yes/No
			Yes/No

Name of Person Completing Record: Elissa Pachacz

* Note: A Councillor making a disclosure must (80A(3)) make a disclosure under s79 and complete a Disclosure of Conflict of Interest Form.

** Councillor disclosing to an assembly that he or she has a conflict of interest must leave the assembly prior to the matter being discussed and not return until the item has been considered.

Complete this Section

Date of Assembly: 6/2/2018

Name of Committee or Group (if applicable): Youth Advisory Committee

Time Meeting Commenced: 6.30pm

Name of Councillors Attending:

Cr Jake Keogh, Deputy Mayor

Cr Jackson Taylor

Name of Members of Council Staff Attending:

Katie Scott

Tony Justice

Peter Gore

Matters Considered:

1. Induction
2. Terms of Reference

Any conflict of interest disclosures made by a Councillor attending: * Nil

Name	Disclosure (refer front of form)	Relevant Matter	Left Assembly **
			Yes/No
			Yes/No
			Yes/No

Name of Person Completing Record: Katie Scott

* Note: A Councillor making a disclosure must (80A(3)) make a disclosure under s79 and complete a Disclosure of Conflict of Interest Form.

** Councillor disclosing to an assembly that he or she has a conflict of interest must leave the assembly prior to the matter being discussed and not return until the item has been considered.

Complete this Section

Date of Assembly: 12/2/2018

Name of Committee or Group (if applicable): Special Issues Briefing

Special Issues Briefing

Time Meeting Commenced: 7.25pm

Name of Councillors Attending:

Cr Adam Gill

Cr John Mortimore, Mayor

Cr Tony Holland

Cr Jake Keogh, Deputy Mayor

Cr Lisa Cooper

Cr Peter Lockwood

Cr Darren Pearce

Cr Jackson Taylor

Cr Nicole Seymour

Name of Members of Council Staff Attending:

Tony Doyle

Rodney McKail

Ian Bell

Andrew Dowling

Michael Fromberg

Peter Gore (Item 1)

Angelo Kourambas

Daniel Clarke (Item 1)

Kerry Stubbings

Matters Considered:

1. Eastern Football League
2. Ferntree Gully Cemetery
3. Draft Submission – Local Government Act Exposure Draft

Any conflict of interest disclosures made by a Councillor attending: * Nil

Name	Disclosure (refer front of form)	Relevant Matter	Left Assembly **
			Yes/No
			Yes/No
			Yes/No

Name of Person Completing Record: Rodney McKail

* Note: A Councillor making a disclosure must (80A(3)) make a disclosure under s79 and complete a Disclosure of Conflict of Interest Form.

** Councillor disclosing to an assembly that he or she has a conflict of interest must leave the assembly prior to the matter being discussed and not return until the item has been considered.

Complete this Section

Date of Assembly: 13/2/2018

Name of Committee or Group (if applicable): Knox Central Advisory Committee

Time Meeting Commenced: 6.00pm

Name of Councillors Attending:

Cr Jake Keogh, Deputy Mayor

Cr Lisa Cooper

Cr Peter Lockwood

Cr Darren Pearce

Cr Jackson Taylor

Name of Members of Council Staff Attending:

Tony Doyle

Angelo Kourambas

Samantha Mazer

Tanya Clark

Matters Considered:

1. Project Delivery Update
 - Operations Centre Relocation
 - Site Design and Development
 - Civic Amenity
2. Knox Central – Planning and Development Approach

Any conflict of interest disclosures made by a Councillor attending: * Nil

Name	Disclosure (refer front of form)	Relevant Matter	Left Assembly **
			Yes/No
			Yes/No
			Yes/No

Name of Person Completing Record: Samantha Mazer

* Note: A Councillor making a disclosure must (80A(3)) make a disclosure under s79 and complete a Disclosure of Conflict of Interest Form.

** Councillor disclosing to an assembly that he or she has a conflict of interest must leave the assembly prior to the matter being discussed and not return until the item has been considered.

Complete this Section

Date of Assembly: 15/2/2018

Name of Committee or Group (if applicable): Knox Community Safety, Health and Wellbeing Advisory Committee

Time Meeting Commenced: 9.30am

Name of Councillors Attending:

Cr John Mortimore, Mayor

Cr Jackson Taylor

Name of Members of Council Staff Attending:

Lisette Pine

Rosie Tuck

Samantha Spooner

Tony Justice

Matters Considered:

1. Draft Terms of Reference
2. Mental Health/Suicide Prevention Part 2 Discussion
3. Mental Health Service Mapping
4. Proposal for Mental Health Working Group
5. Organisational Updates – Current Health and Wellbeing Issues, Activities, Challenges and Opportunities
6. Funding Opportunities Update

Any conflict of interest disclosures made by a Councillor attending: * Nil

Name	Disclosure (refer front of form)	Relevant Matter	Left Assembly **
			Yes/No
			Yes/No
			Yes/No

Name of Person Completing Record: Lisette Pine

* Note: A Councillor making a disclosure must (80A(3)) make a disclosure under s79 and complete a Disclosure of Conflict of Interest Form.

** Councillor disclosing to an assembly that he or she has a conflict of interest must leave the assembly prior to the matter being discussed and not return until the item has been considered.

Complete this Section

Date of Assembly: 19/2/2018

Name of Committee or Group (if applicable): Special Issues Briefing

Time Meeting Commenced: 6.30pm

Name of Councillors Attending:

Cr John Mortimore, Mayor

Cr Tony Holland

Cr Jake Keogh, Deputy Mayor

Cr Lisa Cooper

Cr Peter Lockwood

Cr Darren Pearce

Cr Jackson Taylor

Cr Nicole Seymour

Cr Adam Gill

Name of Members of Council Staff Attending:

Tony Doyle

Sam Mazer

Ian Bell

Dale Monk

Michael Fromberg

Matt Hanrahan

Angelo Kourambas

James Morris

Kerry Stubbings

Andrew Dowling

Matters Considered:

1. Long Term Financial Forecast

2. Capital Works Major Projects

Any conflict of interest disclosures made by a Councillor attending: * Nil

Name	Disclosure (refer front of form)	Relevant Matter	Left Assembly **
			Yes/No
			Yes/No
			Yes/No

Name of Person Completing Record: Rodney McKail

* Note: A Councillor making a disclosure must (80A(3)) make a disclosure under s79 and complete a Disclosure of Conflict of Interest Form.

** Councillor disclosing to an assembly that he or she has a conflict of interest must leave the assembly prior to the matter being discussed and not return until the item has been considered.

Complete this Section

Date of Assembly: 21/2/2018

Name of Committee or Group (if applicable): Knox Arts & Culture Advisory Committee

Time Meeting Commenced: 6.30pm

Name of Councillors Attending:

Cr Peter Lockwood

Cr Jackson Taylor

Name of Members of Council Staff Attending:

Peter Gore

Elissa Pachacz

Jo Herbig

Jeannie Mueller

Matters Considered:

1. Consultation:
 - a) Knox Civic Art Collection Management Policy
 - b) Knox Public Art Advisory Group Consultation
 - c) Immerse Review Consultation
2. 2018 Planning: KACAC 2018 Action Plan

Any conflict of interest disclosures made by a Councillor attending: * Nil

Name	Disclosure (refer front of form)	Relevant Matter	Left Assembly **
			Yes/No
			Yes/No
			Yes/No

Name of Person Completing Record: Elissa Pachacz

* Note: A Councillor making a disclosure must (80A(3)) make a disclosure under s79 and complete a Disclosure of Conflict of Interest Form.

** Councillor disclosing to an assembly that he or she has a conflict of interest must leave the assembly prior to the matter being discussed and not return until the item has been considered.

Complete this Section

Date of Assembly: 22/2/2018

Name of Committee or Group (if applicable): Early Years Advisory Committee

Time Meeting Commenced: 6.30pm

Name of Councillors Attending:

Cr Adam Gill

Name of Members of Council Staff Attending:

Vicky Kindilien

Robyn Renkema

Beck Wright

Matters Considered:

1. Early Years Advisory Committee Terms of Reference and Membership
2. Early Childhood Reform Plan, Department of Education and Training
3. Early Years Advisory Committee Workplan 2018
4. Early Years Advisory Committee Roundtable Discussion and Key Themes

Any conflict of interest disclosures made by a Councillor attending: * Nil

Name	Disclosure (refer front of form)	Relevant Matter	Left Assembly **
			Yes/No
			Yes/No
			Yes/No

Name of Person Completing Record: Beck Wright

* Note: A Councillor making a disclosure must (80A(3)) make a disclosure under s79 and complete a Disclosure of Conflict of Interest Form.

** Councillor disclosing to an assembly that he or she has a conflict of interest must leave the assembly prior to the matter being discussed and not return until the item has been considered.

Complete this Section

Date of Assembly: 27/2/2018

Name of Committee or Group (if applicable): Knox Multicultural Advisory Committee

Time Meeting Commenced: 6.30pm

Name of Councillors Attending:

Cr Jake Keogh, Deputy Mayor

Cr Peter Lockwood

Name of Members of Council Staff Attending:

Joan Pepi

Kathy Parton

Joy Temple

Matters Considered:

1. Welcoming Cities Presentation
2. Knox City Council Transport and Traffic Team Presentation
3. Reports from Knox Multicultural Advisory Committee Members
4. Knox City Council Community Access and Equity Implementation Plan Report

Any conflict of interest disclosures made by a Councillor attending: * Nil

Name	Disclosure (refer front of form)	Relevant Matter	Left Assembly **
			Yes/No
			Yes/No
			Yes/No

Name of Person Completing Record: Joan Pepi

* Note: A Councillor making a disclosure must (80A(3)) make a disclosure under s79 and complete a Disclosure of Conflict of Interest Form.

** Councillor disclosing to an assembly that he or she has a conflict of interest must leave the assembly prior to the matter being discussed and not return until the item has been considered.

Complete this Section

Date of Assembly: 27/2/2018

Name of Committee or Group (if applicable): Youth Advisory Committee

Time Meeting Commenced: 6.30pm

Name of Councillors Attending:

Cr Jackson Taylor

Name of Members of Council Staff Attending:

Katie Scott

Tony Justice

Elissa Pachacz

Brit Josephs

Matters Considered:

1. Knox Community Arts Centre Consultation – exploring the use of KCAC by young people

Any conflict of interest disclosures made by a Councillor attending: * Nil

Name	Disclosure (refer front of form)	Relevant Matter	Left Assembly **
			Yes/No
			Yes/No
			Yes/No

Name of Person Completing Record: Katie Scott

* Note: A Councillor making a disclosure must (80A(3)) make a disclosure under s79 and complete a Disclosure of Conflict of Interest Form.

** Councillor disclosing to an assembly that he or she has a conflict of interest must leave the assembly prior to the matter being discussed and not return until the item has been considered.

Complete this Section

Date of Assembly: 5/3/2018

Name of Committee or Group (if applicable): Special Issues Briefing

Time Meeting Commenced: 6.31pm

Name of Councillors Attending: Cr Adam Gill (from 7.04pm)

Cr John Mortimore, Mayor Cr Tony Holland

Cr Jake Keogh, Deputy Mayor Cr Lisa Cooper

Cr Peter Lockwood (from 6.57pm) Cr Darren Pearce

Cr Jackson Taylor Cr Nicole Seymour

Name of Members of Council Staff Attending:

Tony Doyle Andrew Dowling

Michael Fromberg Dale Monk

Paul Dickie James Morris

Kerry Stubbings

Ian Bell

Matters Considered:

1. 2018-19 Draft Annual Plan

2. 2018-19 Business Cases

3. Operational Budget

4. Fees and Charges

Any conflict of interest disclosures made by a Councillor attending: * Nil

Name	Disclosure (refer front of form)	Relevant Matter	Left Assembly **
			Yes/No
			Yes/No
			Yes/No

Name of Person Completing Record: Rodney McKail

* Note: A Councillor making a disclosure must (80A(3)) make a disclosure under s79 and complete a Disclosure of Conflict of Interest Form.

** Councillor disclosing to an assembly that he or she has a conflict of interest must leave the assembly prior to the matter being discussed and not return until the item has been considered.

Complete this Section

Date of Assembly: 8/3/2018

Name of Committee or Group (if applicable): Knox Affordable Housing Advisory Committee

Time Meeting Commenced: 6.30pm

Name of Councillors Attending:

Cr John Mortimore, Mayor

Cr Peter Lockwood

Name of Members of Council Staff Attending:

Sharon Barker

Anthony Petherbridge

Matters Considered:

1. Social Housing Opportunities in Knox – Update
 - Stamford Park
 - Kingston Links
 - Boral Scoresby
 - 609-621 Burwood Highway, Knoxfield
 - Former Boronia Heights School
 - Correspondence to Department of Health and Human Services
 - Engagement with potential partners
2. Social Housing Investment Planning 2017-18 Grants for Local Government
3. Wantirna Caravan Park Closure – Update
4. Eastern Affordable Housing Alliance – Update
5. Knox City Council's Advisory Committees
6. Feedback from Advisory Committee Members

Any conflict of interest disclosures made by a Councillor attending: * Nil

Name	Disclosure (refer front of form)	Relevant Matter	Left Assembly **
			Yes/No
			Yes/No
			Yes/No

Name of Person Completing Record: Sharon Barker

* Note: A Councillor making a disclosure must (80A(3)) make a disclosure under s79 and complete a Disclosure of Conflict of Interest Form.

** Councillor disclosing to an assembly that he or she has a conflict of interest must leave the assembly prior to the matter being discussed and not return until the item has been considered.

12. MOTIONS FOR WHICH NOTICE HAS PREVIOUSLY BEEN GIVEN**12.1 NOTICE OF MOTION 76 – AMENDMENT TO THE ELECTRONIC GAMING POLICY****COUNCIL MEETING – 27 MARCH 2018****NOTICE OF MOTION - No. 76****Amendment to the Electronic Gaming Policy (Policy no. 2001/09)**

I hereby give notice that it is my intention to move at the Ordinary Meeting of Council on 27 March 2018 the following motion:

That Council:

1. Add a new action to the Electronic Gaming Policy (Policy no. 2001/09) under section 6.4.1 (*Plan and Manage*) to further mitigate the harmful impacts of electronic gaming machines on individuals and the community which states:
 - No Knox City Council ratepayer funded or sponsored meeting, function or event of any kind will be held at a Knox hotel, club or premises that operate electronic poker machines.

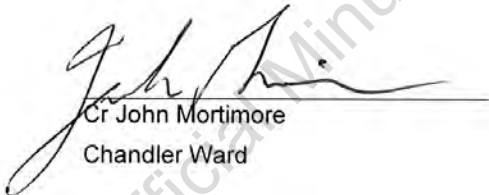

Cr John Mortimore
Chandler Ward



12.1 NOTICE OF MOTION 76 – AMENDMENT TO THE ELECTRONIC GAMING POLICY**COUNCIL RESOLUTION****MOVED: CR. MORTIMORE****SECONDED: CR. KEOGH**

That Council:

1. Add a new action to the Electronic Gaming Policy (Policy no. 2001/09) under section 6.4.1 (Plan and Manage) to further mitigate the harmful impacts of electronic gaming machines on individuals and the community which states:
 - No Knox City Council ratepayer directly funded or sponsored meeting, function or event of any kind will be held at a Knox hotel, club or premises that operate electronic poker machines.

CARRIED UNANIMOUSLY

Official Minutes of Knox City Council

13. SUPPLEMENTARY ITEMS**ALL WARDS****13.1 DRAFT MEETING PROCEDURE AND USE OF COMMON SEAL LOCAL LAW OF 2018****SUMMARY:** *Coordinator Governance (Andrew Dowling)*

A draft of the proposed Meeting Procedure and Use of Common Seal Local Law of 2018 has been prepared to replace the current local law which will sunset on 10 July 2018.

RECOMMENDATION

That Council

1. Commence the statutory process in accordance with Part 5 of the Local Government Act 1989 to make the Meeting Procedure and Use of Common Seal Local Law of 2018.
2. Endorse the draft Meeting Procedure and Use of Common Seal Local Law of 2018 in Attachment 1 for the purposes of community consultation and invite submissions under Section 223 of the Local Government Act 1989 to be received at the Council Offices no later than 5.00pm on Tuesday 3 May 2018.
3. Appoint the following Committee of Council comprising Cr _____, Cr _____, and Cr _____ to consider any submissions received.
4. To authorise the Chief Executive Officer or such person as the Chief Executive Officer nominates for the purposes of giving effect to this resolution, to:
 - a. fix the day, time and place of the meeting to consider submissions; and
 - b. provide any person who has requested to appear in person to be heard in support of their submission with reasonable notice of that meeting.

1. INTRODUCTION

The Local Government Act 1989 (the Act) requires Council to make a local law governing the conduct of meetings of the Council and of Special Committees of Council.

The current Meeting Procedure and Use of Common Seal Local Law of 2008 (the current MPLL) commenced operation on 10 July 2008 and is due to expire (i.e. its 'sunset date') on 10 July 2018. After this date, the Local Law will cease to apply.

13.1 Draft Meeting Procedure and Use of Common Seal Local Law of 2018 (cont'd)

In order to comply with the requirements of the Act, Council must make a new local law, which is proposed to be titled the Meeting Procedure and Use of Common Seal Local Law of 2018 (The MPLL18).

Officers consider that the current MPLL has been generally successful in regulating the security and use of Council's common seal; regulating the proceedings for the election of the Mayor; and regulating proceedings of Ordinary and Special meetings of Council and Meetings of Special Committees.

As such, officers consider it appropriate that the new local law be generally consistent with its predecessor and the MPLL18 has been prepared on that basis.

2. DISCUSSION

The draft MPLL18 has been prepared based on the current MPLL with amendments to:

- ensure compliance with the Local Government Act, but with a view to the Act being re-made later this year;
- improve the structure, clarity or readability of the local law;
- improve, simplify or clarify procedural matters;
- reflect changes current custom and practice and business norms;
- correct incidental formatting, numbering, and/or grammatical issues;

The draft MPLL18 is included as Appendix 1 to this report and the track changes tool has been used to highlight the changes from the current MPLL.

A schedule of the changes, outlining the rationale for each change is included as part of the Community Impact Statement in Appendix 2. Changes of note include:

- Removal of references to advisory committee meetings. (Council may still regulate the conduct of such committees by reference to the MPLL18 through for example, Council policy or committee terms of reference.)
- Formalisation of Council's decision to appoint a Deputy Mayor
- A requirement that notices of motion be submitted 2 working days prior to the meeting to allow more time for Councillors to consider such motions to and facilitate greater public transparency.
- Introduction of a requirement that notices of rescission or amendment be supported by a mover and seconder before they can be lodged. Additional clarification has also been provided regarding the type of decisions which may not be the subject of such notices, and circumstances in which a decision is taken to have been "acted upon".

13.1 Draft Meeting Procedure and Use of Common Seal Local Law of 2018 (cont'd)

- Clarification of the minimum timelines for circulating agendas, and the inclusion of digital delivery as a means of distribution.
- Inclusion of new provisions regarding supplementary reports to draw a clear distinction between supplementary reports and urgent business
- Clarification of provisions regarding Reports by Councillors to reflect current custom and practice.
- Provisions regarding recording of proceedings have been amended to:
 - Ensure broadcasting meetings is also regulated, in addition to recording;
 - Enable staff to record proceedings for the purposes of preparing the Minutes or keeping a record of the meeting.
 - Clarify that recording and or broadcasting of proceedings may be authorised by the Mayor / Chairperson; or by resolution of Council.
- Inclusion of a new provision formalising the process for determining “leave of the meeting” as required by certain provisions of the local law.

3. CONSULTATION

Before the draft Local Law can be adopted, Council is required to place the draft MPLL18 on public exhibition and to hear submissions if requested under section 223 of the Local Government Act. This provides the community with an opportunity to make submissions in relation to the proposed local law. The community will be informed of this process by way of a Public Notice and a notice in the Government Gazette.

Consultation to date on the draft MPLL18 has been largely internal, focusing on practical or procedural issues that have arisen over the 10 years of operation of the current MPLL. A key consideration for the draft however, was the Exposure Draft of the Local Government Bill released by for public consultation in December 2017, as changes to the Act could have significant implications for the MPLL18. This was particularly the case given the Victorian Government’s timeline indicates transitioning to a new Act commencing from 1 July 2018.

Reviewing the Local Government Bill has consequently delayed the review of the MPLL18 and the timelines for public consultation and the making of a new MPLL18 are now quite tight, due to the sunset date of the local law in July 2018.

The timeframe is considered adequate however, taking into consideration the relatively few changes proposed to the current MPLL, and that being generally consistent with the current MPLL, the MPL18 is expected to be largely uncontroversial.

13.1 Draft Meeting Procedure and Use of Common Seal Local Law of 2018 (cont'd)

It is also noted that the prospect of a change to the Local Government Act 1989 means that while the local law is made with a 10 year horizon, the lifecycle of the MPLL2018 may be as short as 18 months. This is because if the Local Government Bill is enacted, Governance Rules to replace the MPLL18 are expected to be required to be in place by 1 January 2020. This would require a further round of community consultation on the new Governance Rules.

The timeline for the making of the MPLL18 is set out below and includes public consultation and consideration of public submissions in accordance with Section 223 of the Local Government Act:

27 March 2018	Supplementary report to the Council meeting to commence the process to make a local law
28 March to 1 May 2018	Public notice period including notices in the Government Gazette and local papers
11 May to 15 June 2018	Consideration of submissions and hearing of public submissions by committee
25 June 2018	Consideration and adoption of a new local law by Council
26 June to 10 July 2018	Gazettal and commencement of the new local law

The date, time and place of the meeting to hear submissions on the proposed Local Law will be directly notified to those who have asked to be heard. The date, time and place will be determined with the committee once established.

4. ENVIRONMENTAL/AMENITY ISSUES

There are no environmental or amenity issues arising as a consequence of this report or the adoption of the Meeting Procedure and Use of Common Seal Local Law of 2018.

5. FINANCIAL & ECONOMIC IMPLICATIONS

The costs to develop and implement the Meeting Procedure and Use of Common Seal Local Law of 2018 will be met within the current budget and include the cost of legal advice and public notices.

6. SOCIAL IMPLICATIONS

Adoption of a new Meeting Procedure and Use of Common Seal Local Law of 2018 will ensure Council continues to comply with its obligations under the Act. A robust and effective local law will assist Council to ensure that decision-making is transparent and that high standards of integrity and accountability promoting public confidence in Council's processes and decisions.

13.1 Draft Meeting Procedure and Use of Common Seal Local Law of 2018 (cont'd)**7. RELEVANCE TO KNOX COMMUNITY AND COUNCIL PLAN 2017-2021**

Goal 8 “We have confidence in decision making”.

8. CONFLICT OF INTEREST

Under section 80c of the Local Government Act 1989 officers providing advice to Council must disclose any interests, including the type of interest.

Officer Responsible – Rodney McKail - In providing this advice as the Officer Responsible, I have no disclosable interests in this report.

Author – Andrew Dowling - In providing this advice as the Author, I have no disclosable interests in this report

9. CONCLUSION

In order to ensure Council meets its obligations under the Local Government Act 1989, it is recommended that Council commencing the statutory processes to make the Meeting Procedure and Use of Common Seal Local Law of 2018, as detailed in this report.

Council will then have an opportunity to consider any submissions received during the public exhibition period, before considering the final draft of the Meeting Procedure and Use of Common Seal Local Law of 2018 for adoption at its meeting on 25 June 2018.

10. CONFIDENTIALITY

There are no confidentiality issues related to this report

**13.1 Draft Meeting Procedure and Use of Common Seal Local Law of 2018
(cont'd)****COUNCIL RESOLUTION****MOVED: CR. LOCKWOOD****SECONDED: CR. KEOGH****That Council**

- 1. Commence the statutory process in accordance with Part 5 of the Local Government Act 1989 to make the Meeting Procedure and Use of Common Seal Local Law of 2018.**
- 2. Endorse the draft Meeting Procedure and Use of Common Seal Local Law of 2018 in Attachment 1 for the purposes of community consultation and invite submissions under Section 223 of the Local Government Act 1989 to be received at the Council Offices no later than 5.00pm on Tuesday 3 May 2018.**
- 3. Appoint the following Committee of Council comprising Cr Lockwood, Cr Mortimore, and Cr Keogh to consider any submissions received.**
- 4. To authorise the Chief Executive Officer or such person as the Chief Executive Officer nominates for the purposes of giving effect to this resolution, to:**
 - a. fix the day, time and place of the meeting to consider submissions; and**
 - b. provide any person who has requested to appear in person to be heard in support of their submission with reasonable notice of that meeting.**

CARRIED



KNOX CITY COUNCIL

PROPOSED

**Meeting Procedure and
Use of Common Seal
Local Law
2018**

TABLE OF CONTENTS

PART 1 - INTRODUCTION		1
1. Title		1
2. Period of Operation		1
3. Purpose		1
4. Authorising Provisions		1
5. Area of Operation		1
6. Definitions		2
7. Form and Use of the Common Seal		43
8. Authority for Use of Common Seal		43
9. Keeping of the Common Seal		43
10. Unauthorised Use of the Common Seal		43
11. Procedure for Election of Mayor		54
12. Election of Deputy Mayor, Chairpersons and Committee Members		76
13. Chairperson		76
PART 4 - MEETING PROCEDURES DIVISION 1 - COUNCIL AND SPECIAL MEETINGS		98
14. General		98
15. Date, Time and Place of Meetings		98
16. Notice of Meeting		98
17. Agendas		98
18. Order of Business		109
19. Business Notices of Motion		119
20. Notice of Amendment or Rescission		1140
21. Reports by Councillors		1211
22. Urgent Business		1311
23. Questions without Notice		1311
24. Suspension of Standing Orders		1412
25. No Motions may be accepted during Suspension of Standing Orders		1412
26. Special Meetings		1412
27. Minutes		1412
28. Confirmation of Minutes		1513
29. Quorum and Adjournment		1513
30. Failure to Raise a Quorum		1614
31. Failure to Maintain a Quorum		1614
32. Time Limit for Meetings		1614
33. Addressing Meetings		1714
34. Motions and Amendments		1715
35. Procedure for Moving a Motion		1715
36. Procedure for Moving an Amendment		1816
37. Foreshadowing Motions		1916
38. Withdrawal of Motions		1917
39. Separation of Motions		2018
40. Debate		2018
41. Order of Speaking		2018
42. Chairperson May Speak		2018
43. Speaking to Subject Matter		2018
44. Points of Order		2018
45. Interruptions, Interjections and Relevance		2018
46. Resumption of Adjourned Debate		2118
47. Disorderly Expressions		2119
48. Personal Explanation		2119
49. Time Limits		2119
50. Gallery to be Silent		2119
51. Removal of Disorderly Visitors		2119

52.	Chairperson May Adjourn Disorderly Meeting	<u>2119</u>
53.	Suspensions	<u>2119</u>
54.	Removal from the Meeting	<u>2219</u>
55.	Procedural Motions	<u>2220</u>
56.	Voting	<u>2220</u>
57.	Vote to be Taken in Silence	<u>2220</u>
58.	Casting Vote	<u>2220</u>
59.	Divisions	<u>2320</u>
60.	Leave of the meeting	<u>2321</u>
61.	Public Question Time	<u>2321</u>
62.	Addressing the Council	<u>2522</u>
63.	Production of Documents	<u>2522</u>
64.	Recording and Broadcasting Proceedings	<u>2522</u>
65.	Petitions	<u>2622</u>
66.	Offences	<u>2623</u>

DIVISION 2 - PROVISIONS APPLYING ONLY TO SPECIAL COMMITTEE

MEETINGS	<u>2724</u>	
67.	Purpose	<u>2724</u>
68.	Application Generally	<u>2724</u>
69.	Quorum	<u>2724</u>
70.	Notice of Meetings	<u>2724</u>
71.	Public Submissions	<u>2724</u>
72.	Application Specifically	<u>2824</u>
73.	“Call-Up” Requests by Other Councillors	<u>2825</u>

DIVISION 3 - OTHER COMMITTEES

2825		
74.	Purpose	<u>2825</u>
75.	Application Generally	<u>2825</u>
76.	Application Specifically	<u>2825</u>

Official Minutes of Knox City Council

PART 1 - INTRODUCTION

1. Title

This Local Law is known as the Meeting Procedure and Use of Common Seal Local Law of 2018.

2. Period of Operation

This Local Law commences to operate on [11 July 2018](#) and ceases to operate on [11 July 2028](#) unless revoked earlier. Upon its commencement, [the Meeting Procedure and Use of Common Seal Local Law 2008](#) is revoked.

3. Purpose

The purposes of this Local Law are to:

- (a) Revoke [the Meeting Procedure and Use of Common Seal Local Law 2008](#);
- (b) Regulate the use and control of the **Council's common seal**;
- (c) Prohibit unauthorised use of the **common seal** or any device resembling the **common seal**;
- (d) Regulate the proceedings for the election of the **Mayor**;
- (e) Regulate proceedings of Ordinary and **Special meetings of Council and Meetings of Special Committees and Advisory Committees of Council**;
- (f) Provide penalties for non observance of the provisions of this Local Law;
- ~~(g) Authorise the charging of fees as permitted by the Act for the provision of information; and~~
- (h) Generally maintain the peace, order and good government of the municipal district.

4. Authorising Provisions

This Local Law is made by the Knox City **Council** under the provisions of Sections 91 and 111 and Schedule 8 to the **Act**.

5. Area of Operation

This Local Law operates throughout the whole of the municipal district.

6. Definitions

Unless inconsistent with the subject matter, the following words and phrases in this Local Law have the meaning indicated:

WORD(S)	MEANING
Act	The Local Government Act 1989 <u>or its successor</u> ;
Advisory Committee	An Advisory Committee established by Council.
Agenda	The notice of a Meeting setting out the business to be transacted at the Meeting .
<u>Amendment</u>	<u>A minor alteration to a motion designed to improve the motion without altering its intent or material impact.</u>
Authorised Signatory	Includes any Director , the Manager <u>Governance & Strategy</u> and any Councillor .
Chairperson	The Chairperson of the Meeting and includes an acting, temporary or substitute Chairperson.
Chief Executive Officer	The Chief Executive Officer of Council .
common seal	The common seal of Council .
<u>Communicate electronically</u>	<u>In respect of communication to and from councillors includes an email sent to the email account that is provided by the Council or the provision of documents transmitted via a secure software application to a digital device</u>
Council	Means Knox City Council
Council Meeting (or 'Meeting')	Any Ordinary Meeting or Special Meeting of Council .
Councillor	A Councillor of Council .
Director	A member of staff occupying a second-level position in the core part of the organisational structure of Council .
<u>Deputy Mayor</u>	<u>The Deputy Mayor of Council, elected by Council whether in accordance with the Act, this Local Law or otherwise</u>
formal motion	A motion set out in Schedule 1.
Mayor	The Mayor of Council and includes a person acting as the Mayor.
Meeting	An Ordinary Meeting or a Special Meeting of Council , or a Special Committee meeting or an Advisory Committee meeting.
Minutes	The collective record of proceedings of Council Meetings .
Notice of Motion	A notice setting out the text of a motion which is proposed to be moved at the next relevant Meeting .
offence	A wilful act or default contrary to the Local Law.
Officer	A person employed on Council staff.
Ordinary Meeting	<u>An Ordinary Meeting of Council, at which only general business may be transacted.</u> <u>Has the same meaning as in Local Government Act 1989</u>
Penalty Unit	Has the same meaning as in the Sentencing Act 1991.
point of order	A procedural point, not involving the substance of a matter before a Meeting .
<u>procedural motion</u>	<u>A motion set out in Schedule 1.</u>

WORD(S)	MEANING
<u>reasonable notice</u>	<u>Generally includes, but is not limited to, -a notice in a newspaper circulating in the municipal district; -or a notice board accessible to the public at Council's offices; or a notice on Council's website.</u>
<u>recording or broadcasting device</u>	<u>means any device which is being used to:</u> <ul style="list-style-type: none"> • <u>photograph or otherwise record visual images;</u> • <u>to make an audio recording;</u> • <u>to broadcast photographs or visual images; and or</u> • <u>to make an audio broadcast;</u>
Special Committee	<u>A committee with delegated powers established pursuant to the Act.</u> A special committee established pursuant to Section 86, 87 or 88 of the Act.
Special Meeting	<u>Has the same meaning as in Local Government Act 1989</u> A Meeting convened under section 84 of the Act.
Statutory Meeting	A Special Meeting held for the election of Mayor , <u>and which may also include (but is not limited to):</u> <ul style="list-style-type: none"> • <u>the election of a Deputy Mayor;</u> • and <u>appointment of Councillors to various Council and external Committees; and</u> • <u>Taking the Oath of Office</u> Taking the Oath of Office
<u>Supplementary Report</u>	<u>A report circulated by the Chief Executive Officer in relation to matters that have arisen since the publication of the Agenda</u>

Official Minutes of Knox City Council

PART 2 - THE COUNCIL'S COMMON SEAL

7. Form and Use of the Common Seal

- (1) The **common seal** must have in it the words "Knox City Council".
- (2) The **common seal** must be used only on the authority of **Council** or the **Chief Executive Officer** and every document to which the common seal is affixed must be signed by the **Chief Executive Officer** and an **Authorised Signatory of Council**.

8. Authority for Use of Common Seal

The **common seal** must be affixed to a document ~~only~~:

(a) on the authority of Council, a Special Committee, or the Chief Executive Officer; and

(b) for the purpose of giving effect to a decision which has been made by:

- (i) resolution of an Ordinary or Special Council Meeting ~~made by Council resolution~~;
- (ii) ~~made by~~ resolution of a **Special Committee** to which power to use the **common seal** has been delegated; or
- (iii) ~~made by~~ the **Chief Executive Officer** or a **Director** under delegation.

9. Keeping of the Common Seal

The **Chief Executive Officer** ~~or the Officer to whom the duty has been delegated~~ must keep the **common seal** in safe custody.

10. Unauthorised Use of the Common Seal

Any person who uses the **common seal** or any device resembling the **common seal** other than in accordance with **clause 8** is guilty of an **offence**.

PENALTY: 10 Penalty Units

PART 3 - ELECTION OF MAYOR AND DEPUTY MAYOR

11. Procedure for Election of Mayor

- (1) The **Mayor** must be elected at a **Statutory Meeting** specifically convened for the purpose and held:
 - (a) annually, or otherwise in accordance with section 74 of the Act; or
 - (b) as soon as possible after there occurs any vacancy in the office of **Mayor**.
- (2) The **Chief Executive Officer** must prepare the **Agenda** for the **Statutory Meeting** in time to give each **Councillor** not later than 5pm on the working day prior to the day fixed for the holding at least 24 hours notice of the **Statutory Meeting**.
- ~~(3) Only the business specified in the Statutory Meeting Agenda can be transacted at the Statutory Meeting.~~
- ~~(3) At the commencement of the Statutory Meeting, the Chief Executive Officer must act as temporary Chairperson and Returning Officer.~~
- ~~(4) The Agenda for the Statutory Meeting must include the making of the declaration of office and taking the oath of allegiance by each Councillor in accordance with sections 63 and 64 of the Act.~~
- ~~(4a) The Chief Executive Officer must open the Statutory Meeting and may then preside over the meeting until a Mayor is elected.~~
- ~~(4b) Once all Councillors have made the declaration of office and taken the oath of allegiance the meeting may elect a temporary Chairperson.~~
- ~~(4c) The Chief Executive Officer will seek nominations for a temporary Chairperson of the Statutory Meeting at which the election of Mayor is to be conducted.~~
- ~~(4d) The temporary Chairperson must not be a candidate for the position of Mayor at that meeting.~~
- ~~(5) At the commencement of proceedings to elect the Mayor At any Meeting to elect the Mayor the temporary Chairperson must deal with:~~
 - ~~(a) the receipt of nominations for the election of Mayor; and~~
 - ~~(b) the election of the Mayor.~~
- (6) ~~Only the business specified in the Statutory Meeting Agenda can be transacted at the Statutory Meeting.~~
- ~~(7) Any Councillor is eligible for election or re-election to the office of Mayor¹.~~

¹ Under Section 78(1) of the Local Government Act 1989, a candidate for the office of **Mayor** must not be precluded from participating in the debate or voting on the election of **Mayor**.

(87) In determining the election of **Mayor** the following will apply²:

- (a) The **Chief Executive Officer** must invite nominations for the office of **Mayor**. If there is only one nomination (which must be seconded), the candidate nominated must be deemed to have been duly elected.
- (b) If there is more than one nomination (each of which must be seconded), the **Councillors** present at the **Meeting** must vote for one of the candidates by a show of hands ~~(or by secret ballot if **Council** so resolves)~~.
- (c) In the event of a candidate receiving an absolute majority of the votes, that candidate must be declared to have been duly elected.
- (d) In the event of no candidate receiving an absolute majority of the votes the candidate with the fewest number of votes must be declared to be a defeated candidate. If because of an equality of votes no candidate can be declared to be a defeated candidate a second vote will be taken. If after the second vote there is still an equality of votes and no candidate can be declared to be a defeated candidate, the defeated candidate will be determined by lot. In conducting the lot the names of all candidates that have the least number of votes must be placed in a container. The first name drawn will be deemed to be the defeated candidate.

No further nominations must be accepted and the **Councillors** present at the **Meeting** must then vote for one of the remaining candidates by a show of hands ~~(or by secret ballot if **Council** so resolves)~~.
- (e) If one (1) of the remaining candidates receives an absolute majority of the votes, he or she must be declared to have been duly elected. If none of the remaining candidates receives an absolute majority of the votes, the process of declaring the candidates with the fewest number of votes a defeated candidate and voting for the remaining candidates by a show of hands ~~(or by secret ballot if **Council** so resolves)~~ must be repeated until one (1) of the candidates receives an absolute majority of the votes. That candidate must be declared to have been duly elected.
- (f) In the event of two (2) remaining candidates having an equality of votes and one (1) of them having to be declared duly elected, the result will be determined by lot. In conducting the lot, the names of the remaining candidates, having an equality of votes, will be placed in a container. The first name drawn will be deemed to have been duly elected.
- (g) The **Chief Executive Officer** will conduct the lot.

Note: "an equality of votes" takes place when all votes cast are evenly distributed between two or more nominees.

This would not be so where for example there were four votes for one nominee, four votes for another and one vote for a third candidate. In such case, resort would be had to the process in clause 11(7)(d) whereby the candidate with the fewest votes (1) would be eliminated.

Where for example, the distribution of votes was three votes for each of three nominees, resort would be had to the process in clause 11(7)(d) whereby if, after a second vote, there remains an equality of votes, the a lot shall be conducted to determined the defeated candidate.

² Given the provisions of section 90(1)(d) of the Act, it is assumed that "an equality of votes" can only take place when all votes cast are evenly distributed between two or more nominees. This would not be so where for example there were four votes for one nominee, four votes for another one and one for another (in which case resort would then be had to the clause 11(d) process). If alternatively the distribution were to be three votes for each of three nominees, paragraph (iv) and section 90(2) would require determination by lot (regardless of the fact that no nominee had a majority of votes).

11A12. Election of Deputy Mayor, Chairpersons and Committee Members Delegates

(1) Council may elect a Deputy Mayor for a period of time specified by the Council or otherwise in accordance with the Act;

(4a2) The procedure used for the election of Mayor shall, as nearly as is practicable, be used for:

a. the election of Deputy Mayor;

b. The election of a temporary chairperson for an ordinary Council meeting, Special Council Meeting or Special Committee; and

c. the appointment of Councillors to positions on Council Committees and external committee where the number of candidates exceeds the number of vacant positions;

(4b3) Where there is an equality of votes between candidates under this clause the Chairperson has a second vote.

In determining:

_____ (a) _____ the Deputy Mayor (if Council resolves to appoint a Deputy Mayor)

_____ (b) _____ the **Chairperson** for a **Special Committee**; or

_____ (c) _____ delegates to another organisation

_____ **Council** must follow, as nearly as is practicable, the procedure for election of **Mayor**.

_____ (2) _____ This clause is subject to:

_____ (a) _____ the requirements of the **Act** in relation to the chairing of **Meetings**; and

_____ (b) _____ the requirements of the **Act** in relation to voting.

_____ (3) _____ The **Mayor** (if present) will preside over an election of the Deputy Mayor.

1213. Chairperson

(1) After the election of the **Mayor** is determined at the Statutory Meeting, the **Mayor** must assume the position of **Chairperson**.

(2) The **Mayor** must chair all **Council Meetings** at which he or she is present.

(3) Unless Council resolves otherwise, the **Mayor** must chair all **Special Committee Meetings** at which he or she is present.

13. Where Mayor is Absent

(4) If the **Mayor** is unable to attend ~~absent from~~ or remain at a **Council Meeting** for any reason; is not present within 15 minutes of the scheduled commencement time of a Council meeting, or is required to declare a conflict -of interest:

(a) The Deputy Mayor will act as Chairperson; or if not present

(b) A Councillor who was the immediate past Mayor will act as Chairperson; or if not present

(c) a temporary Chairperson is to be elected.

(1) ~~the Chief Executive Officer must take the Chair and invite nominations from the Councillors present for a temporary Chairperson. If there is more than one nomination~~

~~the **Chief Executive Officer** will act as Returning Officer for the election of a temporary **Chairperson**. If there is more than one nomination the procedure for determining the temporary **Chairperson** will be in accordance with clause 11.~~

- ~~(2) The **Chairperson** may vacate the Chair for the duration of any item under discussion whereupon a temporary **Chairperson** elected by the **Meeting** must take the Chair until such item has been determined.~~

Official Minutes of Knox City Council

PART 4 - MEETING PROCEDURES

Division 1 - Council and Special Meetings

14. General

- (1) In all cases not otherwise provided for herein, the rules, forms and usages of the Victorian Parliament are to apply, so far as they are applicable, to the proceedings of **Council**.
- (2) Where a circumstance has not been provided for in this Local Law, or it is unclear how it should be dealt with, **Council** may determine the matter by resolution.
- (3) **Council** may, by resolution, adopt policies which complement this Part and which facilitate the conduct of **Meetings** or the conduct and actions of **Councillors** in the proper and appropriate fulfilment of their role and function in the public office of **Councillor**.

15. Date, Time and Place of Meetings

- (1) The dates, times and places of **Meetings** are within the discretion of **Council**.
- (2) **Council** may, by resolution, at an **Ordinary Meeting** or, where permissible, a **Special Meeting** fix the day and time upon which any **Ordinary Meeting** or [Special Committee meeting](#) must be held.
- (3) **Council** may change the date, time and place of any **Council Meeting** which has been fixed and must provide **reasonable notice**³ of the change to the public.

16. Notice of Meeting

~~For the purposes of section 89(4) of the Act, t~~The **Chief Executive Officer** must give **reasonable notice** to the public of any **Council Meeting**.

17. Agendas

- (1) ~~The **Chief Executive Officer** must, subject to Clause 17(2), send (whether personally, by mail, or otherwise) or communicate electronically to every Councillor the **Agenda** for an **Ordinary Meeting** not later than 5pm on the working day prior to the day fixed for the holding of the **Meeting**.~~
~~The **Chief Executive Officer** must send the **Agenda** for an **Ordinary Meeting** to every **Councillor**, at his or her residential address or such other address as nominated by that **Councillor**, not less than 48 hours before the time fixed for the holding of the **Meeting**.~~
- (2) Subject to any resolution of **Council**, the **Chief Executive Officer** will consult with individual **Councillors** to determine the method of delivery to be used under clause 17(1).
- (3) An **Agenda** ~~need not be~~ **must not be** delivered to a **Councillor** who has been granted leave of absence unless the **Councillor** has, in writing, requested the **Chief Executive Officer** to continue to provide **Agendas** for **Meetings** held during the period of leave.
- (4) The **Chief Executive Officer** may include any matter on an **Agenda** which he or she thinks should be considered by **Council** at the **Ordinary Meeting** to which the **Agenda** relates.

³Reasonable notice generally includes an advertisement in a newspaper circulating in the municipal district, a notice on a notice board accessible to the public at Council's offices and on Council's website.

- (5) The **Chief Executive Officer** may, after distribution of the **Agenda** pursuant to Clause 17(1) prepare a **supplementary report** for inclusion in the **Agenda**. A **supplementary report** sent to **Councillors** less than 1 working day before the time fixed for holding the **Meeting** shall be considered under **Urgent Business** pursuant to Clause 22.

~~18. Business~~

- ~~(1) Unless otherwise provided in this Local Law, no business may be conducted at an **Ordinary Meeting** unless it is business notice of which has been given either by inclusion in the **Agenda** or any report accompanying the **Agenda** or in a **Notice of Motion**.~~
- ~~(2) A **Councillor** may up to one hour before the commencement time of a **Meeting** lodge any **Notice of Motion** on any item that they wish to move at the **Meeting**, and:~~
- ~~(a) if lodged must be lodged in writing with the **Chief Executive Officer**;~~
- ~~(b) if received more than 24 hours before the **Meeting**, the **Chief Executive Officer** must distribute a copy of the **Notice of Motion** to all **Councillors** prior to commencement of the **Meeting**;~~
- ~~(c) if received within 24 hours of the **Meeting**, the **Chief Executive Officer** must distribute a copy of the **Notice of Motion** to all **Councillors** attending the **Meeting** prior to commencement of the **Meeting**;~~
- ~~(d) if lodged, the **Chairperson** must call on the **Councillor** to move the **Notice of Motion** in conjunction with clause 19(1)(i) of the **Agenda**; and~~
- ~~(e) must be deemed withdrawn if not moved by the **Councillor** when invited by the **Chairperson** to do so.~~

1918. Order of Business

- (1) ~~(1) Unless otherwise provided in this Local Law, no business may be conducted at an **Ordinary Meeting** unless it is business notice of which has been given either by inclusion in the **Agenda** or any report accompanying the **Agenda** or in a **Notice of Motion** or **Notice of Amendment or Rescission**.~~
- (2) Unless **Council** resolves otherwise but subject to clause 19(3), the business of an **Ordinary Meeting** must be conducted in the following order:
- (a) Opening
- (b) Apologies and requests for leave of absence;
- (c) Disclosures of interest or conflict of interest of any **Councillor**;
- (d) Confirmation of **Minutes**;
- (e) Presentations of petitions and memorials;
- (f) Reports by **Councillors**:
- (a) Committees, delegates, professional development and conferences; and
- (b) Ward Issues.
- (g) Consideration of reports by **Officers**;
- (h) Matters deferred or continued from previous **Meetings**;
- (i) Motions for which notice has previously been given;

- (j) Supplementary ~~items~~ reports;
 - (k) Urgent business;
 - (l) Call up items;
 - (m) Questions without notice; and
 - (n) Confidential business where the **Meeting** is closed to the public ~~under section 89(2) of in accordance with~~ the **Act**.
- (23) Public Question Time will be held following the completion of business on the **Agenda** relating to planning matters unless determined otherwise by resolution of **Council**.

19. Business Notices of Motion

- ~~(21) A Councillor may, up to the close of business two working days prior to up to one hour before the commencement time of a Meeting, lodge any Notice of Motion on any item that they wish to move at the Meeting, and:~~
- ~~(a) if lodged must be lodged in writing with the Chief Executive Officer;~~
 - ~~(b) if received in time for inclusion on the Agenda for the Meeting, the Chief Executive Officer must include the Notice of Motion in that Agenda;~~
 - ~~(c) If not received in sufficient time for inclusion on the Agenda, the Chief Executive Officer must distribute a copy of the Notice of Motion to all Councillors and publish the Notice of Motion on the Council website as soon as is practicable;~~
 - ~~(b) if received more than 24 hours before the Meeting, the Chief Executive Officer must distribute a copy of the Notice of Motion to all Councillors prior to commencement of the Meeting;~~
 - ~~(c) if received within 24 hours of the Meeting, the Chief Executive Officer must distribute a copy of the Notice of Motion to all Councillors attending the Meeting prior to commencement of the Meeting;~~
- (2) If a **Notice of Motion** is lodged other than in accordance with Clause 19(1) it must, unless withdrawn, be included in the Agenda for the following **Meeting**.
- ~~(d) if lodged, the Chairperson must call on the Councillor to move the Notice of Motion in conjunction with clause 19(1)(i) of the Agenda; and~~
- (3) If a **Councillor** who has lodged a **Notice of Motion** is absent from the **Meeting** or fails to move the motion when called upon by the **Chairperson**, any other **Councillor** may himself or herself move the motion.
- ~~(e) must be deemed withdrawn if not moved by the Councillor when invited by the Chairperson to do so.~~
- (4) If a notice of motion is not moved in accordance with clause 19(3) the **Notice of Motion** shall be deemed to have lapsed for want of a mover.
- (5) A **Notice of Motion** may be withdrawn by a request in writing lodged with the **Chief Executive Officer** at any time prior to the publication of the notice in an **Agenda** or on Council's website. Otherwise, the item must be dealt with at a **Meeting**

20. Notice of Amendment or Rescission

- (1) Subject to Clause 20(2), two or more **Councillors** may propose a motion to amend or rescind a decision of **Council** provided:

- (a) a notice is delivered to the **Chief Executive Officer** not later than the close of business on the working day following the **Meeting** at which the decision was made outlining:
- (i) the decision proposed to be amended or rescinded; and
- (ii) the **Meeting** and date when the decision was made; and
- (b) the previous motion has not been acted upon.
- (2) Rescission or amendment motions are not permissible in respect of planning permit resolutions, planning scheme amendment resolutions or contract / tender acceptance resolutions.
- (3) A Notice of Amendment or Rescission will be considered and managed as a **Notice of Motion** under this Local Law except as provided in this Clause.
- (4) For the purposes of clause 20(1)(b) the grounds on which a motion will be deemed to have been acted upon include, but are not limited to:
- a) the contents or substance of a motion have been formally communicated to a person whose interests are materially affected by it; or
- b) a statutory process has been commenced;
- (5) No action or further action must be taken to implement a resolution of which a **Notice of Amendment or Rescission** has been given.
- (6) The **Chief Executive Officer** must:
- (a) Advise all **Councillors** of any **Notice of Amendment or Rescission** delivered under this clause within 24 hours of receiving it.
- (b) List any such **Notice of Amendment or Rescission** on the **Agenda** of the next **Ordinary Meeting** under the heading of **Notices of Motion** for consideration and debate.
- (7) A rescission or amendment of a previous motion must be passed by a majority of the elected **Councillors**.
- (8) A second or subsequent **Notice of Amendment or Rescission** must not be considered by **Council** until a period of three (3) months has elapsed after the date of the **Meeting** at which the first or last **Notice of Amendment or Rescission** was dealt with.
- (4A) A Notice of Motion cannot be considered in relation to a matter that is subject of a rescission motion within three calendar months of the rescission having been dealt with, unless a notice signed by a majority of elected **Councillors** is submitted to the **Chief Executive Officer**.

2021. Reports by Councillors

- (1) A report of a **Councillor** may include advice regarding:
- ~~(a) a report on any committee on which a **Councillor** represents **Council** and will generally provide an update of any meeting or action that has occurred since the last **Council Meeting**;~~
- (a) meetings of any committees on which a **Councillor** represents **Council** that have been held since the last **Council Meeting**;
- (b) other meetings the **Councillor** has attended, or actions undertaken since the last **Council Meeting**;

~~(c) any professional development activity undertaken or conference attended in association with his or her role as a Councillor; and~~

~~(b) an update of up to four minutes on Ward issues of which Council should be made aware. A maximum of two such issues can be raised at any Meeting.~~

~~(d) an update of up to four minutes on Ward issues of note.~~

~~(2) A **Special Committee** is not required to report on matters delegated to that **Special Committee**.~~

(2) **Councillors** may report to **Council** in a written or verbal form ~~on any issue in respect of which they are acting as a delegates of **Council**.~~

2422. Urgent Business

(1) Business must not be admitted as urgent business unless it:

(a) relates to or arises out of a matter which has arisen since distribution of the **Agenda**; and

(b) cannot safely or conveniently be deferred until the next **Ordinary Meeting**.

(2) **Council** may resolve by a majority of those present to admit (without the required notice) an item considered to be urgent business.

(3) The process for raising urgent business will be as follows:

(a) a **Councillor** will indicate to the **Chairperson** his or her intention to request consideration of an item of urgent business.

(b) when called upon by the **Chairperson**, the **Councillor** must state the nature of the business and the nature of urgency, also explaining why it could not have been incorporated on the initial **Agenda** or reasonably deferred to a subsequent **Council Meeting**, and why it cannot be considered as a "Call Up" item.

(c) after this brief explanation by the **Councillor**, the **Chairperson** will call on the **Councillor** to move that the item be considered in accordance with Clause 34. In doing so **Council** will be aware of the provisions of ~~sub-clause 22(1)~~.

~~Once moved and seconded the motion to include an item of Urgent business may be debated like any other normal motion.~~

(d) once an urgent item has been admitted, the **Councillor** must first move the motion in its entirety. in accordance with Clause 34. ~~If the motion is seconded the normal debate will pursue. If it is not seconded the motion lapses for want of a seconder.~~

(e) if requested by the **Chairperson**, the motion must be written and presented to the **Chairperson** when moved and seconded.

(f) if the motion to ~~consider/admit~~ the ~~additional~~ item of urgent business is not carried, no further discussion can occur.

~~(4) The **Chief Executive Officer**, in consultation with the **Mayor**, may prepare a written **supplementary report** on any item of business that has arisen since the preparation of the **Agenda**. **Councillors** must receive a copy of any **supplementary report** at least 24 hours before the time fixed for holding the **Meeting**.~~

2223. Questions without Notice

(1) Any **Councillor** may ask a question without notice.

- (2) The question must be directed to the **Chairperson** but may require an answer from the **Chairperson**, a **Councillor** or an **Officer**.
- (3) The **Chairperson** or **Councillor** may respond if he or she deems it appropriate, however the **Chairperson**, **Councillor** or **Officer** may take the question on notice and provide written advice within 5 working days.

2324. Suspension of Standing Orders

- (1) Subject to clause 19, the provisions of this Local Law may be suspended for a particular purpose by resolution of **Council**.
- (2) The suspension of such provisions (standing orders) may only be used to enable full discussion of any issue without the constraints of formal Meeting procedure.
- (3) The purpose of such suspension is to enable the formalities of Meeting procedure to be temporarily suspended while an issue is discussed.
- (4) Such suspension should not be used purely to dispense with the processes and protocol of the government of **Council**.
- (5) Once the discussion has taken place and before any motions can be put, standing orders must be resumed.

2425. No Motions may be accepted during Suspension of Standing Orders

No motion may be accepted by the Chair or be lawfully dealt with during any suspension of standing orders.

2526. Special Meetings

- (1) The **Mayor** or at least three **Councillors** may by a written notice to the **Chief Executive Officer** call a **Special Meeting** of the **Council**.
- (2) The notice necessary to call a **Special Meeting** must be delivered to the **Chief Executive Officer** in sufficient time to enable reasonable notice to be given to **Councillors** and members of the public.
- (3) In giving such notice, **Councillors** should have regard to any need for preparatory investigations to enable the business to be undertaken.
- (4) The notice referred to in clause 25(1) must specify the date and time of the **Special Meeting** and the business to be transacted.
- (5) The **Chief Executive Officer** must call the **Special Meeting** as specified in the notice.
- (6) Unless all **Councillors** are present and unanimously agree to deal with another matter, only the business specified in the notice may be transacted.

2627. Minutes

The **Minutes** must record the business of the **Meeting** and in particular:

- (1) The name of the **Councillors**:
 - (a) who were present and a record of their attendance relative to items considered during the entire **Meeting**; and
 - (b) who submitted apologies or have been granted leave of absence;
- (2) The names of Executive **Officers** in attendance and their organisational titles;
- (3) Any disclosures of interest or conflicts of interest;

- (4) Arrivals and departures (including temporary departures) of **Councillors** during the course of the **Meeting**;
- (5) Each motion and amendment moved (including motions and amendments that lapse for want of a seconder) and motions and amendments withdrawn by resolution or by leave of the **Meeting**;
- (6) Whether motions or amendments were carried or lost;
- (7) The vote cast by each **Councillor** upon a division, either FOR or AGAINST or any Councillor who has abstained, and the declaration of the result of the division on the motion or amendment;
- (8) The failure of a quorum;
- (9) Closure of the **Meeting** to members of the public in accordance with the provisions of section 89(2) of the Act;
- (10) When specifically requested by a **Councillor**, a record of his or her support or opposition for any motion; and
- (11) Any other matter which the **Chief Executive Officer** thinks should be recorded to clarify the intention of the **Meeting** or the reading of the **Minutes**.

2728. Confirmation of Minutes

- (1) At every **Council Meeting**, the **Minutes** of the preceding **Meeting** must be dealt with as follows:
 - (a) if the **Minutes** have been delivered to each **Councillor** at least 48 hours before the **Meeting**, a motion can be passed for confirmation of the **Minutes**; or
 - (b) if the **Minutes** have not been so delivered, a motion may be proposed to allow any adjournment to allow time for the **Minutes** to be read after which a motion can be passed for confirmation of the **Minutes**.
- (2) No discussion is permitted on the **Minutes** except as to their accuracy as a record of proceedings.
- (3) If a **Councillor** is dissatisfied with the accuracy of the **Minutes**, then the **Councillor** must:
 - (a) state the item or items with which he or she is dissatisfied; and
 - (b) propose a motion clearly outlining the alternative wording to amend the **Minutes**.
- (4) Once the **Minutes** are confirmed, the last page must be certified by the **Chairperson**.

2829. Quorum and Adjournment

- (1) A quorum is a majority of the number of **Councillors** within the whole of **Council** as constituted or members of a **Special Committee** which the whole **Special Committee** as constituted comprises, present at the **Meeting**.
- (2) Business must not be conducted at any **Council Meeting** or a **Special Committee Meeting** unless a quorum is present.
- (3) The **Councillors** present at any **Council Meeting** may from time to time adjourn the **Meeting**.
- (4) No discussion is allowed on any motion for adjournment of the **Meeting**, but if on being put the motion is defeated, the subject then under consideration or the next on the

Agenda ~~or any other that may be allowed precedence~~ must be discussed before any subsequent motion for adjournment is moved.

2930. Failure to Raise a Quorum

- (1) If a quorum is not present within 30 minutes of the time appointed for the commencement of a **Council Meeting**:
 - (a) the **Meeting** lapses;
 - (b) the **Chairperson** or in his/her absence the **Chief Executive Officer** must convene another **Council Meeting** to be held within 14 days of the adjourned **Meeting** and ensure that the **Agenda** for it is identical to the **Agenda** for the **Meeting** which has lapsed; and
 - (c) the **Chief Executive Officer** must give all **Councillors** notice of the reconvened **Meeting**.
- (2) ~~Notice pursuant to Despite clause 2930(1)(c), is not required this requirement does not apply~~ in respect of any **Councillor** who has been granted leave of absence pursuant to ~~section 69 of the Act~~ and who has not requested the **Chief Executive Officer**, in writing, to continue to give notice of **Meetings** to be held during the period of leave of absence.

3031. Failure to Maintain a Quorum

- (1) If a quorum cannot be maintained after a **Council Meeting** has commenced the **Chairperson** must adjourn the **Meeting**, and then reconvene the **Meeting** within 30 minutes after it was adjourned, in which case:
 - (a) if a quorum is then present the **Meeting** must resume; or
 - (b) if a quorum is not then present and if, after using his or her best endeavours to restore a quorum, the **Chairperson** is unsuccessful, the **Chairperson** must announce that the **Meeting** has lapsed, whereupon the **Meeting** lapses.
- (2) If a **Meeting** lapses under clause 30(1)(b), the undisposed business must, unless it has already been disposed of at a **Special Meeting**, be included in the **Agenda** for the next **Ordinary Meeting**.
- (3) Despite the loss of a quorum in the circumstances set out in this clause, the business transacted at the **Meeting** to that point will remain valid and be capable of being acted upon.

3132. Time Limit for Meetings

- (1) A **Council Meeting** must not continue after 10.30 pm unless a majority of **Councillors** present at the **Meeting** votes in favour of its continuance.
- (2) In the absence of such continuance resolution, the **Meeting** must stand adjourned to a time, date and place to be determined by the **Chairperson**.
- (3) Where practicable, the **Chairperson** will determine, and advise all **Councillors** present of, the adjourned time, date and place of meeting, prior to closing the **Meeting**.

- (4) In the event that it is impracticable to comply with clause 31(3) the **Chief Executive Officer** must give reasonable notice to each **Councillor** and the public of the date, time and place to which the **Meeting** stands adjourned and of the business remaining to be considered.
- (5) Notice pursuant to ~~Despite~~ clause 31(4), is not required this requirement does not apply in respect of any **Councillor** who has been granted leave of absence pursuant to section 69 of the Act and who has not requested the **Chief Executive Officer**, in writing, to continue to give notice of **Meetings** to be held during the period of leave of absence.

3233. Addressing Meetings

- (1) Once acknowledged by the **Chairperson** as being the next speaker on an item, the **Councillor** has the floor and may stand when addressing the **Meeting** and must not be interrupted unless called to order or time has expired.
- (2) Except for the **Chairperson**, any **Councillor** or person who addresses the **Meeting** must direct all remarks through the Chair.

3334. Motions and Amendments

- (1) Motions and amendments must relate to the powers or functions of **Council**, be clear and unambiguous and not be defamatory or objectionable in language or nature. Except in the case of urgent business, a motion or amendment must be relevant to an item of business on the **Agenda**.
- (2) The **Chairperson** may require any motion or amendment to be put in writing before it is considered.
- (3) The **Chairperson** may refuse to accept any motion or amendment which contravenes this or any other clause.

3435. Procedure for Moving a Motion or Amendment

- (1) The mover must state the motion without speaking to it.
- (2) The **Chairperson** must call for a seconder unless the motion is a call to enforce a **point of order** or a **formal procedural motion** that does not require a seconder.
- (3) If there is no seconder, the motion lapses.
- (4) If there is a seconder, the **Chairperson** must call on the mover to address the **Meeting**. The mover may, without speaking to the motion, reserve his or her address until later in debate.
- (5) After the mover has addressed the **Meeting** (or reserved his or her right to speak), the seconder may address the **Meeting**.

~~(6) After the seconder has addressed the **Meeting** (or after the mover has addressed the **Meeting** if the seconder does not address the **Meeting**), the **Chairperson** must call upon any **Councillor** who wishes to speak against the motion~~

~~(7) If no **Councillor** speaks against the motion, then the **Chairperson** may put the motion or call any other member to speak.~~

~~(6) After the seconder has addressed the **Meeting** (or after the mover has addressed the **Meeting** if the seconder does not address the **Meeting**), the **Chairperson** may call for speakers in alternate sequence speaking against or for the motion.~~

~~(8) Any **Councillor** except the mover or seconder of the original motion may move or second an amendment.~~

(97) A **Councillor** may speak once on the motion except for the mover of the original motion and once on any amendment except for the mover of the original motion (but not the mover of an amendment) who has the right of reply after which the motion must be put to the **Meeting** for decision. The mover may not exercise the right of reply when he or she is the only speaker to the motion, or the last person to speak having reserved the right to speak later in the debate.

(408) A **Councillor** may be permitted by the **Chairperson** to speak more than once to a motion to make a personal explanation.

(449) A **Councillor** calling the attention of the **Chairperson** to a **point of order** is not regarded as speaking to the motion or the amendment.

(4210) No motion or amendment may be altered or withdrawn without the consent of the seconder.

~~(13) Amendments must be dealt with one at a time.~~

~~(14) An amendment must be relevant to the motion upon which it is moved and not negate the original motion.~~

~~(15) A subsequent amendment must not be considered until any previous amendment is decided upon but amendments may be foreshadowed.~~

~~(16) No right of reply is available to an amendment.~~

(4711) The mover and seconder of a motion may propose a variation to the motion if leave of the **Meeting** is granted.

(4812) If leave is granted to vary a motion in accordance with clause 34(11) a **Councillor** who has spoken to motion prior to the variation being permitted, may be permitted by the **Chairperson** to speak more than once to the motion.

~~(18) No further amendments or debate may be accepted after the mover of the original motion has exercised his or her right of reply.~~

(4913) The mover of a motion must not introduce new material when exercising any right of reply.

36. Procedure for Moving an Amendment

~~(1) Any **Councillor** except the mover or seconder of the original motion may move or second an amendment.~~

~~(2) The mover must state the amendment without speaking to it.~~

~~(3) The **Chairperson** must call for a seconder. If there is no seconder, the motion lapses.~~

~~(4) If there is a seconder, the **Chairperson**:~~

~~a) may ask "Is the amendment opposed?"; and~~

~~b) must call on the mover to address the Meeting. The mover may, without speaking to the amendment, reserve his or her address until later in debate.~~

~~(5) After the mover has addressed the **Meeting** (or reserved his or her right to speak), the seconder may address the **Meeting**.~~

~~(6) After the seconder has addressed the **Meeting** (or after the mover has addressed the **Meeting** if the seconder does not address the **Meeting**), the **Chairperson** may call for speakers in alternate sequence speaking against or for the motion.~~

- (7) Any **Councillor** may speak once on any amendment. No right of reply is available to an amendment.
- (8) A **Councillor** calling the attention of the **Chairperson** to a point of order is not regarded as speaking to the amendment.
- (9) No amendment may be altered or withdrawn without the consent of the seconder.
- (10) The mover and seconder of an amendment motion may propose a variation to the amendment if leave of the **Meeting** is granted.
- (11) An amendment must be relevant to the motion upon which it is moved and not negate the original motion.
- (12) Amendments must be dealt with one at a time. A subsequent amendment must not be considered until any previous amendment is decided upon but subsequent amendments may be foreshadowed.
- (13) If an amendment is carried it becomes the substantive motion. The mover and seconder of the amendment become the mover and seconder of the substantive motion. Debate commences as for a new motion.

3537. Foreshadowing Motions

- (1) At any time during debate, a **Councillor** may foreshadow a motion to inform **Council** of his or her intention to move a motion at a later stage in the **Meeting**, but this does not extend any special right to the foreshadowed motion.
- (2) A motion foreshadowed may be prefaced with a statement that, in the event that a particular motion before the Chair is resolved in a certain way, a **Councillor** intends to move an alternative or additional motion.
- (3) A motion foreshadowed has no procedural standing and is merely a means to assist the flow of the **Meeting**.
- (4) The **Chief Executive Officer** is not required to have foreshadowed motions recorded in the **Minutes** until the foreshadowed motion is formally moved. ~~but may do so if it is considered that this would improve clarity in recording the outcomes of the **Meeting**.~~

3638. Withdrawal of Motions

Subject to clauses 35(10) and 36(9) before any motion is put to the vote, it may be withdrawn with leave of the **Meeting**.

3739. Separation of Motions

(1) [The Chairperson may decide to put any motion to the vote in several parts.](#)

(2) Where a motion contains more than one part, a **Councillor** may request the **Chairperson** to put the motion to the vote in separate parts.

3840. Debate

A **Councillor** may speak only when called by the **Chairperson**:

- (a) to speak in debate;
- (b) to ask or answer a question;
- (c) on a **point of order**; or
- (d) to make a personal explanation.

3941. Order of Speaking

If two or more **Councillors** wish to speak at the same time, the **Chairperson** will determine the order of speakers.

4042. Chairperson May Speak

The **Chairperson** may address a **Meeting** upon any matter under discussion, and is not deemed to have left the Chair on such occasions. However, such address should only take place after all other **Councillors** have had the opportunity to address the **Meeting**.

4143. Speaking to Subject Matter

A **Councillor** must not digress from the subject matter of the motion, amendment or business under discussion.

4244. Points of Order

- (1) The **Chairperson** is the final arbiter of all points of order.
- (2) The **point of order** may be taken on the ground that a matter is:
 - (a) contrary to this Local Law;
 - (b) defamatory;
 - (c) irrelevant;
 - (d) outside **Council's** functions or powers;
 - (e) improper; or
 - (f) frivolous or vexatious.
- (3) The ruling of the **Chairperson** upon any **point of order** is not open to any discussion and will be final and conclusive.
- (4) The **Chairperson** may take a **point of order**.

4345. Interruptions, Interjections and Relevance

- (1) A **Councillor** must not be interrupted except by the **Chairperson** or upon a **point of order**.
- (2) If a **Councillor** is interrupted by the **Chairperson** or upon a **point of order**, he or she must remain silent until the **Chairperson** has ceased speaking, or the **point of order** has been determined.

4446. Resumption of Adjourned Debate

If a debate is adjourned by motion, the **Councillor** moving the adjournment has the right to be the first speaker upon the resumption of debate unless he or she has already spoken to the motion or amendment.

4547. Disorderly Expressions

If a **Councillor** or an **Officer** uses any expression that is disorderly or offensive to any other **Councillor** or **Officer**, the **Chairperson** must require the offending **Councillor** or **Officer** to withdraw the expression and make a satisfactory apology to the **Meeting**. A **Councillor** or **Officer** required to withdraw a remark must do so immediately without qualification or explanation.

4648. Personal Explanation

- (1) A **Councillor** or an **Officer** may, at any **Council Meeting** and at a time decided by the **Chairperson**, make a personal explanation for a period not exceeding two (2) minutes on any statement made (whether made at a **Council Meeting** or not) affecting that **Councillor** or **Officer**.
- (2) A personal explanation must not be debated or made for the purpose of furthering debate.

4749. Time Limits

- (1) A **Councillor** must not speak longer than the time set out below unless granted an extension by the **Meeting**:
 - the mover of a motion or amendment - 5 minutes
 - the mover of a motion exercising a right or reply - 2 minutes
 - ~~any Councillor on update of Ward issues under clause 19(1)(f)~~ - ~~2 minutes (per item)~~
 - any Reports by Councillors under Clause 21 - 4 minutes
 - any other **Councillor** on any other matter - 3 minutes
- (2) A motion for the extension of time will, if carried, allow a **Councillor** a further two minutes to speak but ~~no~~ further extensions must not be permitted.

4850. Gallery to be Silent

Any person in the Public Gallery must not, during a **Council Meeting**, interject or take part in the debate and must preserve silence at all times other than where people are permitted to address the **Meeting** as provided elsewhere in this Local Law.

4951. Removal of Disorderly Visitors

If a person in the Public Gallery is called to order by the **Chairperson** and thereafter again acts in breach of this Local Law, the **Chairperson** may order him or her to leave, failing which the **Chairperson** may order him or her to be removed from the Public Gallery.

5052. Chairperson May Adjourn Disorderly Meeting

If the **Chairperson** is of the opinion that disorder in the vicinity of the **Meeting** makes it desirable to adjourn the **Meeting**, he or she may adjourn the **Meeting** to a later time on the same day or to some later day as he or she thinks proper.

5153. Suspensions

Council by resolution may suspend from a **Meeting**, and for the balance of the **Meeting**, any **Councillor** whose actions have disrupted the business of **Council**, and have impeded its orderly conduct.

5254. Removal from the Meeting

The **Chairperson**, or **Council** in the case of a suspension, may ask any **Authorised Officer** or member of the Police Force to remove from the **Meeting** any person who acts in breach of this Local Law or whom the **Chairperson** has ordered to be removed from the Public Gallery under the provisions of this Local Law.

53. Notice of Amendment or Rescission

- ~~(1) A Councillor may propose a motion to amend or rescind a decision of Council provided:~~
- ~~(a) a notice is delivered to the Chief Executive Officer within 24 hours of the Meeting at which the decision was made outlining:~~
- ~~(i) the decision proposed to be amended or rescinded; and~~
- ~~(ii) the Meeting and date when the decision was made; and~~
- ~~(b) the previous motion has not been acted upon.~~
- ~~(2) No action or further action must be taken to implement a resolution of which a notice to rescind or amend has been given.~~
- ~~(3) (a) The Chief Executive Officer must advise all Councillors of any Notice of Motion delivered under this clause within 24 hours of receiving it.~~
- ~~(b) The Chief Executive Officer must list any such Notice of Motion on the Agenda of the next Ordinary Meeting for consideration and debate.~~
- ~~(c) Such Notice of Motion must be deemed withdrawn if not moved at the next Ordinary Meeting.~~
- ~~(4) A second or subsequent Notice of Motion to revoke or amend an earlier resolution must not be considered by Council until a period of three (3) months has elapsed after the date of the Meeting at which the first or last motion of revocation was dealt with.~~

5455. Formal Procedural Motions

Unless otherwise prohibited, **formal procedural motions** may be moved at any time and must be dealt with in accordance with Schedule 1 to this Local Law.

5556. Voting

- (1) When called upon by the **Chairperson**, the **Councillors** present must vote by a show of hands or as **Council** otherwise determines.
- (2) For the purposes of voting at a **Council Meeting**, the **Chairperson** must put the motion or amendment first in the affirmative, then in the negative.
- (3) The **Chairperson** may require that the vote be re-counted as often as may be necessary for him or her to satisfy himself or herself of the result.

5657. Vote to be Taken in Silence

Except that a **Councillor** may call a division, **Councillors** must remain seated in silence while a vote is being taken.

5758. Casting Vote

- (1) In the event of an equality of votes, subject to the **Act** and this Local Law, the **Chairperson** has a second vote.

- (2) Clause ~~5758~~(1) does not apply in the event of an equality of votes in respect of the election of the **Mayor**, or in cases where the **Act** or this Local Law provides that a matter is to be determined by lot.

5859. Divisions

- (1) Immediately after any question is put to a meeting and before the next item of business has commenced, a **Councillor** may call for a division.
- (2) When a division is called for, the vote already taken must be treated as a nullity and the division shall decide the question, motion or amendment.
- (a) As a division is a separate and distinct vote, no Councillor is prevented from changing his or her original vote at the voting on the division.
- (3) If a division is called for, the **Chairperson** must:
- (a) first ask each **Councillor** wishing to vote in the affirmative to rise, or raise a hand (as directed by the **Chairperson**) and must then state the names of those **Councillors** voting in the affirmative; and
- (b) then ask each **Councillor** wishing to vote in the negative to rise, or raise a hand (as directed by the **Chairperson**) and must then state the names of those **Councillors** voting in the negative; and
- (c) if required, then ask each **Councillor** wishing to abstain from voting to rise, or raise a hand (as directed by the **Chairperson**) and must then state the names of those **Councillors** abstaining from voting; and
- (d) declare the result of the division.
- ~~(1) If a division is called by a **Councillor** immediately after a motion is put to the **Meeting** and before the next item of business has commenced, the vote must be taken by **Councillors** voting in the affirmative first rising and then those voting in the negative rising. The **Chairperson** must state the names of **Councillors** so voting, declare the result and have the details recorded in the **Minutes**.~~
- ~~(2) As a division is a separate and distinct vote, no **Councillor** is prevented from changing his or her original vote at the voting on the division, and the voting by division will determine **Council's** resolution on the issue.~~

60. Leave of the meeting

- (1) Where an action or decision under this Local Law is dependent upon obtaining leave of the meeting, the **Chairperson** shall, before taking the action or making the decision:
- (a) outline the action or decision that is proposed to be taken or made to the meeting;
- (b) ask any **Councillor** present to indicate if they oppose the proposed action or decision; and
- if no Councillor indicates opposition, leave of the meeting shall be taken to have been granted.

5961. Public Question Time

- (1) ~~(a)~~ Members of the public are permitted to prepare and submit to an **Ordinary Meeting** up to two (2) questions on any **Council** matter.
- ~~(b) All questions to be asked must be registered by completion of the appropriate form which must be lodged prior to the commencement of Public Question Time. Questions may be lodged online or by facsimile transmission, to the main facsimile transmission number as advertised, up to one (1) hour~~

~~before the published commencement time of the **Meeting**, or in person at the Civic Centre, 511 Burwood Highway, Wantirna South during normal office hours. Any questions being lodged after this time must be done so in person and placed in the question box provided at the place of the **Meeting**.~~

- (a) All questions to be asked must be registered by completion of the appropriate form which must be lodged:
- (i) online via Council's website by close of business on the day fixed for the **Ordinary Meeting**; or
 - (ii) in person at the Civic Centre, 511 Burwood Highway, Wantirna South during normal office hours prior to or on the day fixed for the **Meeting**; or
 - (iii) in the question box provided at the place of the **Meeting** prior to the commencement of the public question time at the **Meeting**.
- (eb) The presentation and answering of questions from persons present in the Public Gallery will occur in accordance with clause 18(3).
- (ec) Questions will be directed to the **Chairperson** who will read the question and ascertain whether the questioner is present in the Public Gallery.
- (ed) If present in the Public Gallery, the questioner will have the right to make a brief introductory statement. The time allowed for such statement and question will be up to two (2) minutes.
- (ee) Where a meaningful response to the question cannot be provided at the **Meeting** by the **Chairperson, Councillors** or staff, or a detailed or researched response is required, the question may be taken on notice, in which case an answer must be provided by letter in writing to the questioner within five (5) working days.
- (ef) Any **Councillor** wishing to provide a personal response to a question will be permitted to do so after the **Chairperson** has had the opportunity to respond.
- (eg) If the questioner is not present in the Public Gallery, the question will not be read; or included in the minutes of the meeting, except at the discretion of the **Chairperson**. A response must be supplied in writing.
- (eh) Where the **Chairperson** deems appropriate, a response must be supplied in writing.
- (ei) Questions and answers should be as brief as possible and no discussion will be allowed on any question except for the introductory statement as provided in paragraph (e).
- (ej) The number of questions that may be asked during a **Meeting** on any one (1) issue will be limited to two. It is at the total discretion of the **Chairperson** which two (2) questions will be asked where there are more than two (2) submitted.
- (ek) The **Chairperson** will have the right to refuse to receive or answer any question, or to take the question on notice.
- (el) A time limit of 30 minutes will apply to Public Question Time but may be extended by resolution of **Council**.
- (em) Meeting procedures as detailed in this Local Law apply during Public Question Time.

~~(2) In the case of **Advisory Committee** or **Special Committee Meetings**, no visitor is entitled to address the **Meeting** without the prior approval of the **Chairperson**.~~

6062. Addressing the Council

Except as provided for in clause ~~61(1)(d) 59(1)(e)~~, a person other than a **Councillor** or **Officer** must not address the **Council Meeting** except:

(a) where until a resolution approving such has been carried by a majority of **Councillors** present at the **Meeting**.

(b) With the approval of the Chairperson and leave of the meeting.

~~**61. Election of Chairpersons and Delegates**~~

~~(1) In determining:~~

~~(a) the **Chairperson** for an **Advisory Committee** or a **Special Committee**; or~~

~~(b) delegates to another organisation~~

~~**Council** must follow, as nearly as is practicable, the procedure for election of **Mayor**.~~

~~(2) This clause is subject to:~~

~~(a) the requirements of section 73 of the **Act** in relation to the chairing of **Meetings**; and~~

~~(b) the requirements of section 90 of the **Act** in relation to voting.~~

6263. Production of Documents

(1) A **Councillor** may, at a **Council Meeting**, require the production of any documents kept in the municipal offices that are directly relevant to the business being considered at the **Meeting**.

(2) The **Chief Executive Officer** must use his or her best endeavours to produce the documents at the **Meeting** or, if this is not feasible, as soon as practicable after that time.

6364. Recording and Broadcasting Proceedings

(1) A person must not operate any recording or broadcasting device at any Council Meeting or Special Committee Meeting without first obtaining:

a. The consent of the **Mayor** or **Chairperson** (as the case may be); or

b. Consent of Council by resolution of the meeting.

(2) Consent granted under Clause 64(1)(a) or Clause 64(1)(b) may be revoked at any time during the course of a Council Meeting or Special Committee Meeting by resolution of Council or the Special Committee.

~~A person must not operate audio tape or other recording equipment at any **Council Meeting**, **Advisory Committee** or **Special Committee Meeting** without first obtaining the consent of the **Mayor** or **Chairperson** (as the case may be). Such consent may at any time during the course of such **Meeting** be revoked whereupon any person operating the audio tape or other recording equipment must cease operating it.~~

(3) Nothing in clause 64(1) applies to any member of Council staff operating any camera or recording device for the purpose of production of the minutes of the meeting or any presentations or keeping a record of the **Council Meeting** or **Special Committee Meeting**.

- (3) Where a **Council Meeting** or **Special Committee Meeting** is to be recorded pursuant to this clause the **Chairperson** must as soon as practicable after the opening of the meeting advise those who are in attendance that their images and/or voices are likely to be recorded during the course of the meeting.

6465. Petitions

- (1) A petition:
- (a) must be in a legible and permanent form of writing, typing or printing;
 - (b) must not be defamatory, indecent, abusive or objectionable in language or substance; and
 - (c) must not relate to a matter beyond the powers of **Council**.
- (2) Every page of a petition must bear the wording of the whole of the petition or request.
- (3) Any signature appearing on a page of a petition which does not bear the wording of the whole of the petition or request must not be considered by **Council**.
- (4) Every page of a petition must be a single piece of paper and must not be affixed to any piece of paper other than another page of the petition.
- (5) No motion may be made on any petition until the next **Ordinary Meeting**, except if the matter or issue is already listed for consideration of **Council** on the **Agenda** for the **Meeting** at which it is presented in accordance with this Local Law, or if **Council** determines by a majority of those present that the matter is urgent and should be dealt with at the **Meeting** at which it is presented or by a **Special Committee**.
- (6) A **Councillor** presenting a petition must state the number of signatures attached to it and the subject matter. The **Councillor** may also speak to the petition.
- (7) A **Councillor** may, when presenting a petition, refer the specific request to an **Officer** for referral to a specific program. An example of the intent of this clause would be to refer a request for playground equipment to the following year's capital work program. If any action would require unallocated expenditure or would change an adopted program within the current financial year, it must be referred back to **Council**. Should a referral occur, there is no requirement for the matter or issue to be considered at the next **Ordinary Meeting** in accordance with clause 65(5).
- (8) After a petition is tabled, the head petitioner must be advised of progress of the particular issue.

6566. Offences

It is an **offence**:

- (a) for a **Councillor** to not withdraw an expression considered by the **Chairperson** to be offensive or disorderly, and to not satisfactorily apologise when called upon twice by the **Chairperson** to do so.

PENALTY: 20 Penalty Units

- (b) for any person, not being a **Councillor**, who is guilty of any improper or disorderly conduct to not leave the Council Chamber when requested by the **Chairperson** to do so.

PENALTY: 20 Penalty Units

- (c) for any person to fail to obey a direction of the **Chairperson** in relation to the conduct of the **Meeting** and the maintenance of order.

PENALTY: 20 Penalty Units

- (d) for any person to append to a petition or joint letter a signature purporting to be that of any other person or in the name of any other person.

PENALTY: 10 Penalty Units

- (e) for a **Councillor** to fail or refuse to leave the Council Chamber after being suspended from a **Meeting**.

PENALTY: 20 Penalty Units

Division 2 - Provisions Applying only to Special Committee Meetings

6667. Purpose

The purpose of this Division is to regulate:

- (a) proceedings at **Meetings of Special Committees** composed solely of **Councillors**; and
- (b) notice to be given of **Meetings of Special Committees** composed solely of **Councillors**.

6768. Application Generally

- (1) Except as provided in this Part, if **Council** establishes a **Special Committee** composed solely of **Councillors**, Part 4, Division 1 of this Local Law applies with any necessary modifications.
- (2) For the purposes of sub-clause (1), a reference in Part 4, Division 1 to:
 - (a) a **Council Meeting** is to be read as a reference to a **Meeting** of the **Special Committee**;
 - (b) a **Councillor** is to be read as a reference to a member of the **Special Committee**; and
 - (c) the **Mayor** is to be read as a reference to the **Chairperson** of the **Special Committee**.

6869. Quorum

The quorum for a **Meeting** of a **Special Committee** composed solely of **Councillors** is the number specified in the most recent instrument of delegation, or, if no number has been specified in an instrument of delegation, a majority of the number of members which the whole **Special Committee** as constituted comprises.

6970. Notice of Meetings

The requirements for notice to the public of any **Council Meeting** also apply to any **Meeting** of a **Special Committee** composed solely of **Councillors** to which powers have been delegated.

7071. Public Submissions

- (1) A **Special Committee** must, at such time as is allocated by it or by **Council**, hear any person wishing to be heard in respect of his or her submissions to **Council** under Section 223 of the [Local Government Act 1989 Act](#).
- (2) Special Committee members may, through the Chair, question any submitter in relation to his or her submission.

7472. Application Specifically

If **Council** establishes a **Special Committee** composed solely of **Councillors**:

- (a) **Council** may; or
- (b) that **Special Committee** may, with the approval of **Council**

resolve that a provision of Part 4, Division 1 does not apply, whereupon that provision will cease to apply to the **Special Committee**.

7273. "Call-Up" Requests by Other Councillors

- (1) If **Council** establishes a **Special Committee** to which powers have been delegated, the **Chief Executive Officer** must ensure that all **Agendas** for **Meetings** of that **Special Committee** are provided to all **Councillors** (whether or not members of the **Special Committee**).
- (2) A **Councillor** who is not a member of a **Special Committee** to which powers have been delegated may give written notice to the **Chairperson** of that **Special Committee** that an item on the **Agenda** is to be "called-up" for consideration by **Council**.
- (3) If a **Chairperson** receives notice that an item is to be "called-up" the **Special Committee** may consider that item and make a recommendation to **Council** about it, but must not exercise a delegated power in relation to it.

Division 3 - Other Committees**7374. Purpose**

The purpose of this Division is to regulate proceedings at **Meetings of Special Committees** (other than those composed solely of **Councillors**) ~~and of **Advisory Committees**.~~

7475. Application Generally

- (1) If **Council** establishes ~~:-~~

~~_____ (a) a **Special Committee**; ~~or~~~~

~~_____ (b) an **Advisory Committee**~~

~~_____ Part 4, Division 1 of this Local Law applies with any necessary modifications.~~

- (2) For the purposes of sub-clause (1), a reference in Part 4, Division 1 to:
 - (a) a **Council Meeting** is to be read as a reference to a **Meeting** of the **Special Committee** ~~of **Advisory Committee**~~ (as appropriate).
 - (b) a **Councillor** is to be read as a reference to a member of the **Special Committee** ~~or **Advisory Committee**~~ (as appropriate); and
 - (c) the **Mayor** is to be read as a reference to the **Chairperson** of the **Special Committee** ~~or **Advisory Committee**~~ (as appropriate).

7576. Application Specifically

If **Council** establishes ~~:-~~

~~_____ (a) a **Special Committee**; ~~or~~~~

~~_____ (b) an **Advisory Committee**,~~

_____ then

- (i) **Council** may; or
- (ii) that **Special Committee** ~~or **Advisory Committee**~~ (as appropriate) may, with the approval of **Council**,

resolve that a provision of Part 4, Division 1 does not apply, whereupon that provision will cease to apply to the **Special Committee** ~~or **Advisory Committee**~~ ~~(as the case may be)~~.

Official Minutes of Knox City Council

PART 5 – SUPPLY OF INFORMATION

76. — Purpose

~~— The purpose of this Division is to enable charging of fees for the supply of information.~~

77. — Supply of Information

~~— Council may set from time to time, fees for the supply of records of Council to members of the public.~~

Official Minutes of Knox City Council

Resolution for making this Local Law was agreed to by the Knox City **Council** on _____ and

THE COMMON SEAL of the)
 KNOX CITY COUNCIL was)
 hereunto affixed in the presence of:)
)
)
Chief Executive Officer)
)
)
Mayor)
)
)
Councillor)

"I certify that this is a true copy of the Meeting Procedure and Use of Common Seal Local Law [2018](#) made by the Knox City Council on _____ in accordance with the requirements of the Local Government Act 1989.

The notices required to be given by the Act appeared in Government Gazette on _____ and in the [<details of newspaper advertising>](#).

A copy of the Local Law was sent to the Minister for Local Government in a letter dated _____.

The Local Law commenced operation on _____ and will expire on _____ unless revoked earlier."

Chief Executive Officer

Official Minutes of Knox City Council

Schedule 1

**FORMALPROCEDURAL MOTIONS
PROCEDURE AND EFFECT**

FORMALPROCEDURAL MOTION	FORM	WHO CAN MOVE OR SECOND	IS A SECONDER REQUIRED?	MATTER IN RESPECT OF WHICH MOTION MAY BE MOVED	WHEN MOTION PROHIBITED	EFFECT IF CARRIED	EFFECT IF LOST
Adjournment of debate to later hour/date	That this matter be adjourned until	Any Councillor	Yes	Any matter	(a) During the election of the Chairperson (b) When another Councillor is speaking	Motion and amendments postponed to the stated time/date	Debate continues unaffected
Adjournment of debate indefinitely	That this matter be adjourned until further notice	Any Councillor	Yes	Any matter	(a) During the election of the Chairperson (b) When another Councillor is speaking (c) When the matter is one in respect of which a call of Council has been made	Motion and amendments postponed but may be resumed: (a) At the same meeting upon motion to resume (b) At any later Meeting if on the Agenda	Debate continues unaffected
Adjournment of meeting to later hour/date	That the meeting be adjourned until	Any Councillor	Yes	Any meeting	(a) During the election of the Chairperson (b) When another Councillor is speaking	Meeting adjourns immediately until the stated time (or date)	Debate continues unaffected

FORMAL PROCEDURE MOTION	FORM	WHO CAN MOVE OR SECOND	IS A SECONDER REQUIRED?	MATTER IN RESPECT OF WHICH MOTION MAY BE MOVED	WHEN MOTION PROHIBITED	EFFECT IF CARRIED	EFFECT IF LOST
Adjournment of Meeting indefinitely	That this Meeting be adjourned until further notice	Any Councillor	Yes	Any matter	(a) During the election of the Chairperson (b) When another Councillor is speaking (c) During a meeting which is a call of the Council	Meeting adjourns until further notice	Debate continues unaffected
The Closure	That the question be now put	A Councillor who has not moved, seconded or spoken to the motion or any amendment of it	No	Any matter	During nominations for Chairperson (NB A closure motion shall not be accepted by the Chairperson unless the Chairperson considers there has been sufficient debate for and against the original motion or amendment)	Motion or amendment in respect of which the closure carried is put to the vote immediately	Debate continues unaffected

FORMALPROCEDURAL MOTION	FORM	WHO CAN MOVE OR SECOND	IS A SECONDER REQUIRED?	MATTER IN RESPECT OF WHICH MOTION MAY BE MOVED	WHEN MOTION PROHIBITED	EFFECT IF CARRIED	EFFECT IF LOST
Laying the question on the table	That the matter lie on the table	A Councillor who has not moved, seconded or spoken to the motion or any amendment of it	Yes	Any matter	(a)During the election of the Chairperson (b)During a Meeting which is a call of the Council	Motion and amendments not further discussed or voted on until: (a) Council resolves to take the question from the table at the same Meeting (b)Matter is placed on an Agenda and the Council resolves to take the question from the table	Debate continues unaffected
Proceeding to the Next Business	That the Meeting proceed to the next business	A Councillor who has not moved, seconded or spoken to the matter which the motion relates	Yes	Any matter	(a)During the election of the Chairperson (b)During a Meeting which is a call of the Council	(a)If carried in respect to a formalprocedural motion , its effect is to remove that motion from consideration (b)If carried in respect to an amendment, its effect is to dispose of the amendment and debate resumes upon the substantive motion	Debate resumed at point of interruption



Community Impact Statement

Meeting Procedure and Use of Common Seal Local Law 2018

Contents

1. Introduction	2
2. Background.....	2
3. Objectives.....	2
4. Evaluation of the proposed Local Law	3
5. Outline of changes introduced by the proposed Local Law.....	8



1. Introduction

Council's Meeting Procedure and Use of Common Seal Local Law 2008 (the current Local Law) was adopted by Council on 24 June 2008 and commenced on 10 July 2008.

The current Local Law is due to expire (i.e. its 'sunset date') on 10 July 2018.

Council is therefore proposing to make the Meeting Procedure and Use of Common Seal Local Law 2018 (the proposed Local Law) to replace the current Local Law. Council provides the following information to the community in respect of the proposed changes introduced as part of the proposed Local Law.

2. Background

The current Local Law was made consistent with the requirements of Section 91(1) of the Local Government Act 1989 which requires a council to make a local law governing the conduct of Council and Special Committee meetings.

The current Local Law has been generally successful in regulating the election of the Mayor; the use of the common seal; and the conduct of Council and Special Committee Meetings over the past decade.

The proposed Local Law is therefore generally consistent with the current Local Law, with changes that are considered:

- necessary as a consequence of changes to the Local Government Act 1989 and the prospect of that Act being re-made in the near future;
- appropriate to improve the structure and readability of the local law;
- prudent following a review of the operation of the current local law;
- appropriate in the experience of officers or Councillors having regard to the operation of the current Local Law.

Changes have also been made as required to correct grammatical errors, capitalization and italicization, or to ensure cross references are correct.

3. Objectives

The purpose of the proposed Local Law is to:

- (a) Revoke the Meeting Procedure and Use of Common Seal Local Law 2008;
- (b) Regulate the use and control of the Council's common seal;
- (c) Prohibit unauthorised use of the common seal or any device resembling the common seal;
- (d) Regulate the proceedings for the election of the Mayor;
- (e) Regulate proceedings of Ordinary and Special meetings of Council and Meetings of Special Committees;
- (f) Provide penalties for non-observance of the provisions of this Local Law;
- (g) Generally maintain the peace, order and good government of the municipal district.

The purpose of the proposed Local Law is generally consistent with the current Local Law, however regulating the proceeding of advisory committee meetings is no longer considered an appropriate purpose for the local law. While regard to the proposed Local Law may be useful or informative for the conduct of advisory committee meetings from time to time, application of the proposed Local Law is not necessary for the efficient conduct of such meetings.

Authorising the charging of fees is also no longer a necessary purpose of the local law. Fees and charges are sufficiently regulated by the provisions of the Local Government Act 1989 (the Act) and adopted as part of Council's annual budget process. As such, the regulation of such fees and charges is no longer a necessary part of the local law.

4. Evaluation of the proposed Local Law

An evaluation of the proposed Local Law follows.

Issue	Evaluation
Measures of success	<p>The success of the proposed Local Law will be best measured by:</p> <ol style="list-style-type: none"> 1. The extent to which it provides for and facilitates the orderly, efficient and fair conduct of elections of the Mayor and Deputy Mayor. 2. The extent to which it provides for and facilitates the orderly, efficient, participative and fair conduct of meetings to which it applies. 3. The extent to which it effectively regulates the use of the common seal.
Existing legislation that might be used instead	<p>Existing legislation cannot be used to achieve the objectives of the proposed Local Law on the basis that:</p> <ol style="list-style-type: none"> 1. Section 91 of the Local Government Act 1989 specifically requires a council to make a local law governing the conduct of Council and Special Committee meetings. 2. Section 5 of the <i>Local Government Act 1989</i> provides that Council must have a common seal the use of which must be in accordance with the local laws of the Council.
State legislation more appropriate	<p>There is no State legislation that can achieve the objectives of the proposed Local Law. As indicated above, State legislation specifically requires the making of a local law governing the conduct of Council and Special Committee meetings use of the Council's common seal.</p>
Overlap of existing legislation	<p>There are provisions in the <i>Local Government Act 1989</i> with respect to the conduct of Council and Special Committee meetings.</p> <p>In light of the recent release of an exposure draft of the Local Government Bill which will be considered by Parliament in mid-2018, particular regard has been had to ensuring there is no overlap, duplication or repetition of the Act in the proposed Local Law.</p> <p>To the extent that the proposed Local Law addresses the same subject material as the Act, it does so in a manner which is consistent with the requirements of the legislation and with a view to possible re-making of the act later in 2018.</p>
Overlap of planning scheme	<p>There are no provisions in the proposed Local Law which overlap with the Knox Planning Scheme.</p>

Issue	Evaluation
Risk assessment	As the proposed Local Law is generally consistent with the current Local Law, a specific risk assessment has not been undertaken.
Legislative approach adopted	<p>The proposed Local Law is necessitated by the provisions of the Act.</p> <p><u>Council's Common Seal</u></p> <p>The MPLL2018 adopts a high impact regulatory approach.</p> <p>This approach is considered appropriate as it provides clear accountability for appropriate use and safekeeping of the Council seal.</p> <p><u>Election of the Mayor and Deputy Mayor</u></p> <p>The proposed Local Law adopts a high impact regulatory approach, setting out the procedural aspects of mayoral elections in a highly prescriptive manner. There are no discretionary provisions or processes for the election of the Mayor.</p> <p>This approach is considered appropriate as it provides certainty and transparency to participants and the community, and ensures elections are conducted in fair and equitable manner.</p> <p>The provisions of this Part of the proposed Local Law also extend to the position of Deputy Mayor and the appointment of Chairpersons and Committee members. In these regards, the proposed local law retains an appropriate level of procedural discretion for Council.</p> <p><u>Conduct of meetings</u></p> <p>The proposed Local Law adopts a medium impact regulatory approach.</p> <p>As it prescribes, with a level of detail, the business that can and can't be transacted and the procedures and protocols of participation, the proposed Local Law is an integral part of Council's governance structure. It provides a foundation for the efficient conduct of the decision making process, and the framework for fair and equitable access and participation of Councillors, Committee members, and where appropriate officers and the community.</p> <p>Whilst being largely prescriptive, the proposed Local Law retains a level of discretion that is considered appropriate to facilitate the orderly conduct of meetings, whilst allowing latitude to deal with particular circumstances of the meeting and business at hand.</p>
Restriction of competition	Having regard to the subject matter of the proposed Local Law, no implications are envisaged with respect to the National Competition Policy.

Issue	Evaluation										
Penalties	<p>The proposed Local Law contains a minimal number of offences which are consistent with the current Local Law.</p> <p>The proposed Local Law contains the following maximum penalties (in general terms):</p> <table border="0" data-bbox="389 524 1203 972"> <tr> <td data-bbox="389 524 986 591">Using the common seal without the authority of Council</td> <td data-bbox="1008 524 1203 557">10 penalty units</td> </tr> <tr> <td data-bbox="389 618 986 685">A Councillor failing to withdraw and apologise for offensive or disorderly expression</td> <td data-bbox="1008 618 1203 651">20 penalty units</td> </tr> <tr> <td data-bbox="389 712 986 779">Not leaving the Chamber when requested by the Chairperson to do so</td> <td data-bbox="1008 712 1203 745">20 penalty units</td> </tr> <tr> <td data-bbox="389 806 986 873">Failing to comply with the Chairperson's direction regarding maintenance of order</td> <td data-bbox="1008 806 1203 840">20 penalty units</td> </tr> <tr> <td data-bbox="389 900 986 967">Signing a purported name to a petition or joint letter</td> <td data-bbox="1008 900 1203 934">10 penalty units</td> </tr> </table> <p>Penalties for some offences are relatively high in comparison to local benchmarking, however the penalties are considered reasonable and appropriate having regard to the effectiveness of the local law in regulating the conduct of council meetings.</p> <p>At the time of writing a penalty unit is \$100.</p>	Using the common seal without the authority of Council	10 penalty units	A Councillor failing to withdraw and apologise for offensive or disorderly expression	20 penalty units	Not leaving the Chamber when requested by the Chairperson to do so	20 penalty units	Failing to comply with the Chairperson's direction regarding maintenance of order	20 penalty units	Signing a purported name to a petition or joint letter	10 penalty units
Using the common seal without the authority of Council	10 penalty units										
A Councillor failing to withdraw and apologise for offensive or disorderly expression	20 penalty units										
Not leaving the Chamber when requested by the Chairperson to do so	20 penalty units										
Failing to comply with the Chairperson's direction regarding maintenance of order	20 penalty units										
Signing a purported name to a petition or joint letter	10 penalty units										
Permits	The proposed Local Law does not make provision for the issue of permits.										
Fees	Fees and charges are considered to be sufficiently regulated by the provisions of the Act and therefore not fees are prescribed by the proposed Local Law.										
Performance standards or prescriptive	<p>It is considered appropriate that the proposed Local Law contains prescriptive standards, to the extent that it sets out the procedures to be followed in the conduct of elections, and Council and Special Committee Meetings. The prescriptive nature of many provisions in the proposed Local Law provide procedural certainty for Councillors, staff and the community.</p> <p>The prescriptive nature of the proposed Local Law also contributes to the fair and equitable application of its provisions.</p>										
Comparison with neighbouring and like Councils	<p>A detailed comparison has not been undertaken with the equivalent local laws of neighbouring municipalities.</p> <p>Each Council develops meeting procedures which address their particular needs and approach to meeting procedure. Anecdotally, there is a both a high degree of similarity and difference in meeting procedures across the local government sector.</p>										
Charter of Human Rights	<p>The proposed Local Law has been reviewed for compatibility with the Charter of Human Rights (the Charter).</p> <p>The key points of engagement with the Charter are in the context of the right to freedom of expression and the right to participate in the conduct of public affairs, directly or through freely chosen representatives.</p>										

Issue	Evaluation
	<p>The proposed Local Law is considered to be fully compatible with the Human Rights Charter. Following is a description of key aspects of the proposed Local Law which are considered relevant to any limitations it imposes upon rights protected by the Charter,</p> <p>The proposed Local Law contains a number of provisions requiring notice to Councillors and the community, facilitating participation in public affairs.</p> <p>It includes prescriptive and performance based approaches, for example including minimum notice period for Councillors and requiring "reasonable" notice for the community. Whilst applying different standards, these provisions are reflective of the relative power of these different groups to access information regarding the business of Council.</p> <p>It also contains a number of provisions which restrict the business which may be conducted at Council meetings and the manner in which councillors or committee members can participate.</p> <p>These could be viewed as limiting freedom of expression and the right to participate in public affairs. Whilst imposing procedural limitations, it does so in a manner which is considered proportionate to the purpose and objectives of both the local law and the meetings it regulates. This includes balancing opportunities for participation (eg during debate for Councillors, or during public question time for the community) with the efficient and orderly conduct of the meeting and the business of Council more generally. Procedural limitations also take into consideration opportunities to ensure the transparency of council decision making. Changes to the submission deadlines for notices of motion for example, restrict the business which may be conducted at a meeting, but enhance opportunities for public participation by facilitating greater notice of the business which may be conducted at a meeting.</p> <p>Rulings on procedural limitations are generally determined by the Chairperson however where appropriate it is clear that rulings may be made by resolution of Council. Whilst these procedural limitations engage the freedom of expression and the right to participate in public affairs, the provisions are expressed in discretionary rather than mandatory form. Such discretion allows rulings to be made in a manner that takes appropriate account of Charter rights where applicable to a decision before the Chairperson or the meeting. The inclusion of a new provisions regarding how 'leave of the meeting' is to be determined is also an appropriate safeguard on the powers of the chairperson, providing an objective process for determining whether such leave granted.</p> <p>The proposed Local Law expressly provides for participation by the community in the conduct of Council meetings through Public Question Time.</p> <p>The proposed Local Law regulates that participation with procedural limitations regarding the form, content and processes to be followed and these limitations engage the freedom of expression and the right to participate in public affairs. The provisions do so however, in a manner which is considered proportionate to the purpose and objectives of both local law and the meetings it regulates, including the efficient and orderly conduct of meetings.</p> <p>Whereas the current Local Law mandates a questioner be in the gallery, an amendment has been made giving the chairperson discretion to relax this requirement. This is considered appropriate where the requirement to be in the chamber for a meeting is</p>

Issue	Evaluation
	<p>an unreasonable limitation on a person's right to participate in the meeting, having regard to their particular circumstances.</p> <p>The proposed Local Law regulates the conduct and behaviors of Councillors, officers and the community. To the extent that it prescribes a standard of behavior that is considered acceptable in the context of Council or committee meetings, it engages both the freedom of expression and right to participate in public affairs. It is considered to do so in a manner which is proportional to the objectives of the local law to provide for the efficient and orderly conduct of meetings.</p> <p>To an extent, the limitations on expression and participation in this section when applied to an individual in context, may also serve to protect the very same rights of another individual. It may also protect their rights to privacy and reputation, and their rights to liberty and security (for example, protection from harassment and threats).</p> <p>The proposed Local Law expands the regulation of recording and broadcasting meetings. While recording and broadcasting can increase the accessibility of meetings and facilitate greater participation, it does so in a way that can impact on a person's right to privacy. New provisions of the proposed Local Law requiring notice of recording or broadcasting provide an appropriate safeguard for attendees concerned for their personal privacy while in attendance at meetings.</p>
Consultation meetings	The amendments proposed to the current Local Law have been developed in consultation with Councillors and Council.
Submissions	<p>Public consultation will be undertaken as part of the process of making the proposed Local Law and anyone interested in making a submission may do so, in accordance with section 223 of the <i>Local Government Act 1989</i>.</p> <p>The written submissions should be addressed to the Chief Executive Officer and should be lodged at or posted to Council's office at 511 Burwood Highway, Wantirna South VIC 3152.</p> <p>Alternatively, submissions may be lodged by email to knoxcc@knox.vic.gov.au or online at Council's website.</p> <p>Written submissions must be received at the Council Offices no later than 5.00pm on Tuesday 3 May 2018.</p> <p>Any person who makes a written submission can ask to be heard by a Council Committee in support of their submission and may be represented by a person (who is specified in their submission), to act on their behalf. The date, time and place of any meeting to hear submissions on the proposed Local Law will be directly notified to those who have asked to be heard.</p> <p>Submitters should note that all submissions received may be made available to the public in full (including any personal information). Submissions may be posted on Council's website. Details from submissions received, including personal information may also be included in the official Council Agenda and Minutes which are permanent public documents and also available on Council's website.</p>



5. Outline of changes introduced by the proposed Local Law

Following is a detailed breakdown of the changes introduced in the Meeting Procedure Local Law 2017, when compared to its predecessor.

The breakdown identifies each section that has been amended, summarising the amendment proposed and providing a brief explanation of the rationale behind the amendment.

This information is provided to assist the community to understand the implications and impact of the differences between the current Local Law and the proposed Local Law.

Official Minutes of Knox City Council

Summary of changes made to the Meeting Procedure and Use of Common Seal Local Law of 2008

Note: Unless otherwise indicated, references to clause numbers in the following table are to the amended clause numbers in the draft Meeting Procedure and Use of Common Seal Local Law of 2018

Clause	Nature of Change	Rationale
1, 2 & 3	Changes to the title and period of operation	Changes reflect the remaking of the Meeting Procedure and Use of Common Seal Local Law of 2008 (the current MPLL) into the Meeting Procedure and Use of Common Seal Local Law of 2018 (MPLL18)
3	Amendments to the purposes of the MPLL18	<p>Reference to regulating Advisory Committees of Council has been removed. The formal meeting procedures in the MPLL18 are not necessarily appropriate to the conduct of Advisory Committees which are typically less formal. While the MPLL18 may be useful or informative for the conduct of advisory committees from time to time, it is not necessary for the MPLL18 to regulate such meetings. It is noted that Council has other appropriate opportunities to require advisory committees to have regard to the MPLL18 if desired, such as in the committee's terms of reference, or in Council policy.</p> <p>Authorising fees and charges has also been removed. Council's power to charge fees for certain documents is established under the Act and fees may be set as part of the Fees and Charges in the annual budget process. As such, this purpose is no longer appropriate to for the MPLL18.</p>
6	Updated definition of "Act"	The definition has been updated to include the successor to the Local Government Act 1989 (the LGA), anticipating it will be remade in the near future.
	New definition of "Amendment"	A definition of "Amendment" will provide greater certainty when applying the provisions of the MPLL18.
	Amended definition of "Authorised Signatory"	The definition has been amended to reflect a change in organisational structure.
	New definition of "Communicated electronically"	The new definition reflects the trend towards digital communication in modern organisations which warrants clear definition of "communicated electronically" to provide certainty in the application of the MPLL18.
	Amended Definition of Council	A grammatical amendment that does not change the substantive effect of the clause.
	New definition of Deputy Mayor	The new definition reflects Council's current practice of appointing a Deputy Mayor and acknowledges the prospect of the role of Deputy Mayor being established in legislation when the LGA is remade.

Summary of changes made to the Meeting Procedure and Use of Common Seal Local Law of 2008

Clause	Nature of Change	Rationale
	Definition of “Formal motion” replaced with “Procedural motion”	The Current MPLL has a schedule of procedural motions which are referred to in the current MPLL as “formal motions”. The change in definition to “procedural motions” is considered clearer drafting.
	Amended definition of Mayor	Council’s practice of appointing a deputy mayor has been reflected where appropriate throughout the MPLL18. Consequently, it is no longer appropriate for the definition of mayor to refer to a person “acting as the Mayor”.
	Change to the definition of “meeting” to remove “Advisory Committees”	While the MPLL18 may be useful or informative for members conducting advisory committees, it is not necessary for the MPLL18 to regulate such meetings.
	Amendment to the definition of Ordinary Meeting by reference to the LGA	Ordinary Meeting is defined under the LGA and the definition has been amended to reference the LGA to avoid duplication and inconsistency.
	A new definition of “reasonable notice” has been inserted	The new definition provides clarity regarding what type of notice will constitute “reasonable notice” for the purposes of the MPLL18.
	A new definition of “recording or broadcasting device” has been included.	The new definition covers any device that is being used to record or broadcast audio or photographs/video of proceedings.
	Amendment to the definition of Special Committee by reference to the LGA	The definition has been updated to remove specific references to the LGA, anticipating it will be remade in the near future.
	Amendment to the definition of Special Meeting by reference to the LGA	Special Meeting is defined under the LGA and the definition has been amended to reference the LGA to avoid duplication and inconsistency.
	Amended definition of “Statutory Meeting”	The definition has been amended to reflect the typical business conducted at Council’s statutory meeting.

Summary of changes made to the Meeting Procedure and Use of Common Seal Local Law of 2008

Clause	Nature of Change	Rationale
	Insertion of a new definition of "Supplementary Report"	The new definition reflects current custom and practice of circulating supplementary reports on occasion.
8	Amendments to provide greater flexibility in the application of Council's common seal.	The LGA provides, generally that a decision of council is a decision made by Council at an ordinary or special council meeting, a resolution of a Special Committee, and includes an officer exercising a delegation. This amendment ensures documents in each of these categories can be sealed if appropriate.
9	Amendments to the Chief Executive Officer's duty to safeguard the Common Seal	Where the duty to safeguard the seal is delegated, it will be done by instrument of delegation, consequently the possibility of delegation is not required to be specified in the MPLL18.
Part 3	Heading updated to Election of Mayor and Deputy Mayor	This change reflects the Council's practice of electing a Mayor and a Deputy Mayor
11	Clarification of provisions regarding the conduct of a Statutory Meeting	<p>References to specific clauses of the Act have been removed in anticipation of the LGA being remade and some references that are no longer correct deleted.</p> <p>Clause 11(1) has been amended to reflect that the Act allows for 2 year mayoral terms.</p> <p>Clause 11(2) has been amended to provide greater clarity regarding the timing of an agenda being distributed for the Statutory meeting.</p> <p>Clause 11(3) has been moved to provide a more logical narrative.</p> <p>Clause 11(4) has been amended to clarify the Chief Executives role in presiding over the meeting until a mayor is elected</p> <p>Clause 11(5) of the MPLL has been deleted as it is considered unnecessary.</p> <p>Clause 11(7) has been amended to remove reference to secret ballots which are no longer permissible under the Act and to refer to the correct chairperson.</p>

Summary of changes made to the Meeting Procedure and Use of Common Seal Local Law of 2008

Clause	Nature of Change	Rationale
12	New Clause regulating the election of the Deputy Mayor, Committee members and chairpersons	Clause 12 provides that the process in Clause 11 for the election of Mayor shall, as nearly as practicable, be used for the election of the Deputy Mayor, Temporary Chairpersons and appointments to Council committees and external committees.
13	Amendments to provisions regarding the Chairperson	<p>Clause 12 has been amended to</p> <ul style="list-style-type: none"> • Clarify the Mayor’s role as Chair of the Statutory Meeting once elected. • Clarify that, unless Council resolves otherwise, the Mayor shall also chair Special Committee meetings at which he or she is present. • Clarify who shall be chairperson in the absence of the Mayor.
15	Amendments to provisions regarding the scheduling of meetings	<p>The changes clarify Council’s power to set the dates of Special Committee meetings.</p> <p>The footnote regarding reasonable notice has been deleted, as this is now a defined term under Clause 6.</p>
16	Amendment of provisions regarding notice of meetings	References to specific clauses of the Act have been removed in anticipation of the LGA being remade. It is noted that references to “reasonable notice”
17	Amendments to provisions regarding agendas	<p>The provisions of Clause 17 set the minimum standard for the distribution of agendas.</p> <p>The minimum standard under the current MPLL is 48 hours’ notice. In the context of Council’s meeting schedule, changes to Clause 17 effectively increase the minimum notice period from the prior Saturday evening to the prior Friday evening. (It is noted that Council has resolved to vary this minimum standard and requires delivery</p> <p>The amendments also reflect the range of modern delivery methods available for the distribution of Agendas. The drafting of Clause 17(2) envisages the method of delivering agendas will be determined on a case-by-case basis with each individual Councillor, in the absence of Council determining the delivery method.</p>

Summary of changes made to the Meeting Procedure and Use of Common Seal Local Law of 2008

Clause	Nature of Change	Rationale
		<p>Clause 17(3) has been amended to be less prescriptive around the delivery of agenda papers to a Councillor who is on a leave of absence.</p> <p>Clause 17(4) of has been amended to clarify it applies only to ordinary Council meetings as the LGA does not give the Chief Executive Officer any discretion to set the agenda for Special Council Meetings. (Special Council Meetings must be called in accordance with the notice or resolution given to the Chief Executive Officer).</p> <p>A new Clause 17(5) has been inserted to provide greater clarity regarding supplementary reports, and the distinction between supplementary reports and urgent business.</p> <p>As previously indicated, the minimum standard for distribution of Agendas under revisions to this clause is the working day prior to the meeting. In the ordinary course of Council's meeting schedule this is the Friday before a Monday meeting, however Council has resolved that agendas be distributed, generally, 7 days before the meeting. Clause 17(5) establishes that supplementary reports may be circulated after an agenda has been circulated, but that any such reports circulated less than 1 working day before the meeting shall be subject considered as Urgent Business according to Clause 22.</p>
18	Consolidation of parts of clauses 18 and 19 of the current MPLL and minor clarifications. Clauses regarding Notices of Motion moved to Clause 19	<p>Clauses 18 and 19 as they are in the current MPLL have been consolidated into a single clause.</p> <p>Clause 18(2)(f)(a) regarding Reports by Councillors has been amended to reflect a broader range of subject matters being reported by Councillors, including attendance at professional development opportunities or conferences. The changes are also reflected at Clause 21.</p>
19	Amendment of provisions regarding notices of motion	<p>Provisions regarding notices of motion have been consolidated into Clause 19.</p> <p>The Victorian Ombudsman's report; <i>Investigation into the transparency of local government decision making December 2016</i> concluded "Where notices of motion are raised without adequate time to be thoroughly researched, they can affect both the quality of decision making and transparency."</p>

Summary of changes made to the Meeting Procedure and Use of Common Seal Local Law of 2008

Clause	Nature of Change	Rationale
20	Provisions regarding Notices of Amendment or Rescission have been moved and clarified	<p>To allow greater opportunity for Councillors to research and consider any proposed notice of motion, the timeline for submitting notices of motion has been reduced from 1 hour prior to the meeting to 2 working days prior to the meeting.</p> <p>The additional notice period also facilitates greater transparency, with a further amendment proposed requiring notices of motion to be made available to the community through publication in the agenda where time allows, and otherwise through publication on Council’s website.</p> <p>Further amendments to clause 19 also clarify how and when a motion may be withdrawn and how a motion must be treated if it is received with insufficient notice.</p>
21	Amendments to provisions regarding reports by Councillors	<p>Given the significance of notices of rescission and amendment, changes to Clause 20 introduce a requirement that a notice have the support of two Councillors before it can be lodged; and support of a majority of elected Councillors to be passed.</p> <p>Changes to Clause 20(2) and 20(4) also clarify when a notice of amendment of rescission cannot be lodged by reference to circumstances in which a decision is taken to have been “acted upon” and by reference to certain decision types (planning permits, planning scheme amendments and the award of contracts/tenders).</p> <p>The provisions also prevent a notice of motion under Clause 19 in relation to the same matter as a notice of rescission, without the support of a majority of Councillors.</p> <p>Clause 21(1) has been revised to provide further examples of matter suitable for inclusion in a Councillor Report and to reflect current custom and practice of Councillors making such reports. While the time limit of up to 4 minutes has been retained for reports of ward issues, the limitation of two ward issues per Councillor has been deleted to provide greater flexibility in reporting.</p> <p>Clause 21(2) has been amended to clarify that Councillors may report to Council in either written or verbal form, reflecting Councillors’ current custom and practice.</p>

Summary of changes made to the Meeting Procedure and Use of Common Seal Local Law of 2008

Clause	Nature of Change	Rationale
		What was clause 20(2) in the current MPLL has been deleted from Clause 21. That clause provided that Special Committees were not required to report to Council, which is not directly related to Reports by Councillors. It is noted that the reporting requirements upon Special Committees can otherwise be established in the Instruments of Delegation for any such committees as required and need not be specified in the MPLL18.
22	Clarification of processes regarding Urgent Business	<p>Minor amendments have been made to Clauses 22(3)(c), (d) and (f) to improve clarity and readability without changing the substantive effect of these provisions.</p> <p>Clause 22(4) has been deleted in favour of a new Clause 17(5) as previously described, which provides greater clarity regarding supplementary reports, and the distinction between supplementary reports and urgent business.</p>
27	Amendments to clarify matters to be recorded in the Minutes	<p>Clause 27(7) has been amended to require the Minutes to record a Councillor abstaining from voting where a division is called.</p> <p>Clause 27(9) has been amended to remove specific references to provisions of the LGA, in anticipation of the legislation being remade.</p>
29	Amendments to provisions regarding adjournment of meetings	Clause 29(4) has been amended to provide greater certainty regarding the next item of business that must to be transacted immediately after a motion for adjournment of the meeting is defeated.
30	Amendments to provisions regarding failure to raise a quorum	Clause 30(2) has been amended to improve clarity and readability without changing the substantive effect of the clause. References to specific provisions of the LGA have also been deleted in anticipation of the legislation being remade.
32	Amendments to provisions regarding time limits for meeting	Clause 32(5) has been amended to improve clarity and readability without changing the substantive effect of the clause.

Summary of changes made to the Meeting Procedure and Use of Common Seal Local Law of 2008

Clause	Nature of Change	Rationale
35	Amendments to provisions regarding moving motions	<p>Provisions for moving a motion have been separated from the provisions regarding moving an amendment to improve clarity and readability.</p> <p>Changes are also made regarding the order of speakers following the Mover and Seconder. The current MPLL makes it mandatory for the Chairperson to call upon speakers opposed to the motion immediately after the mover and seconder have spoken (should they wish to do so). It goes on to provide that if no Councillor speaks against the motion, the Chairperson may then either put the motion, or call on other Councillors to speak.</p> <p>To better reflect current custom and practice, clauses 35(6) and (7) have been replaced with a provision that affords discretion to the Chairperson once the mover and seconder have spoken, to call on speakers to the motion in alternate sequence speaking for and against.</p> <p>Clause 35(12) has been inserted to ensure the Mayor has discretion to allow a Councillor who has spoken to a motion, to speak again where that motion has been varied with the consent of the mover and seconder.</p>
36	A new clause inserted regarding moving amendments	The provisions of clause 36 in relation to moving amendments, are consistent with processes for moving a motion under clause 35.
37	Amendments to provisions regarding foreshadowed motions	Clause 37(4) has been amended to provide certainty that no foreshadowed motion is required to be included in the Minutes of the meeting.
38	Cross references of clauses regarding withdrawal of motions	Clause 38 has been amended to appropriately cross-reference provisions in Clauses 35 and 36 regarding moving and amending motions.
39	Amendment to the Chairperson's power to separate motions	Clause 39 has been amended to provide flexibility to the Chairperson to separate motions at his or her own discretion, as well as at the request of a Councillor.

Summary of changes made to the Meeting Procedure and Use of Common Seal Local Law of 2008

Clause	Nature of Change	Rationale
48	Amendment to provisions regarding personal explanations	Clause 49 has been amended to clarify that a personal explanation must not be used as a means to further debate a matter before Council.
49	Amendment to provisions regarding time limits for speaking	<p>Clause 49(1) has been amended in order to achieve consistency with Clause 21 with regard to report by Councillors.</p> <p>Minor amendments have also been made to Clause 49(2) to improve clarity and readability without changing the substantive effect of the clause.</p>
55	Change of name from Formal to Procedural motions	Clause 55 has been amended to reflect a change in language from “Formal Motion” to “Procedural motions” which improves clarity and readability without changing the substantive effect of the clause.
58	Amendment to provisions regarding casting votes	Clause 58 has been amended to clarify that a casting vote may not apply where a lot is required by the MPLL18, in addition to those required by the LGA.
59	Re-drafting of provisions regarding divisions	Clause 59 has been re-drafted to improve clarity and readability without changing the substantive effect of the clause.
60	New provision inserted regarding leave of the meeting	<p>Leave of the meeting is required before certain actions or decisions can be taken including:</p> <ul style="list-style-type: none"> • Withdrawal of certain motions • Variations to motions by the mover and seconder • Allowing visitors to address the meeting <p>The new Clause 60 provides greater certainty where leave is required, by prescribing the process by which leave of the meeting is to be determined. Clause 60 formalises the current custom and practice of outlining the proposed action or decision to the meeting and asking Councillors present to indicate if they object. The threshold for leave of the meeting is that there is no opposition from any Councillor.</p>

Summary of changes made to the Meeting Procedure and Use of Common Seal Local Law of 2008

Clause	Nature of Change	Rationale
61	Re-numbering of provisions regarding public question time	<p>Clause 61 has been re-numbered for consistency and clarity without changing the substantive effect of the clause.</p> <p>Clause 61(1)(a) has been amended to provide certainty and clarity of the 3 methods for submitting public questions; online; in person at Council's Offices; and in person at the meeting. It also sets appropriate deadlines for each method of submission to ensure that staff have sufficient notice of the questions received by the various methods in order to cause them to be presented at the meeting.</p> <p>Clause 61(1)(e) has been amended to reflect the trend towards digital communication in modern organisations and ensure correspondence with questioners via email will satisfy the requirements of the MPLL18.</p> <p>Clause 61(1)(g) has been amended to provide clarity and certainty that where a questioner is not in the public gallery, that their question will receive a response in writing but will not be read at the meeting, or included in the minutes of the meeting. A caveat has been included giving the Chairperson discretion to vary this approach, which may be appropriate. Such discretion might be exercised for example, in situations where requiring a person to be in attendance at the meeting constitutes an unreasonable imposition on their human rights.</p> <p>Clause 61(2) which relates to visitors has been deleted and appropriate amendments made to Clause 62 Addressing the Council).</p>
62	Amendments to provisions regarding visitors addressing meetings	<p>Amendments have been made to provide discretion to the Chairperson (subject to leave of the meeting) to allow persons other than Councillors and officers to address a meeting. It is not considered necessary to stipulate this provision applies to Special Committee meetings or advisory committees. This is appropriately addressed in Division 3 of the MPLL18 (Division 3 - Other Committees)</p>
64	Amendment to provisions regarding recording of meetings	<p>Clause 64 has been amended to ensure the MPLL18 regulates both recording and broadcasting of Council meetings.</p>

Summary of changes made to the Meeting Procedure and Use of Common Seal Local Law of 2008

Clause	Nature of Change	Rationale
		<p>The reference to the newly defined “recording or broadcasting device” provides broad coverage of the possible devices which may be used to record or broadcast proceedings. The amendments also clarify the decision to record / broadcast meetings may be made by the Mayor / Chairperson or by resolution of Council.</p> <p>A new Clause 64(2) has been inserted which authorises Council staff to record the meetings the purpose of production of the minutes of the meeting or keeping a record of the Council Meeting.</p> <p>Where a meeting is to be recorded under this Clause, a new Clause 64(4) requires the Mayor to provide notice to those in attendance of that recording.</p> <p>References to Advisory Committees have also been removed from the Clause.</p>
71	Amendment to provisions regarding Submissions under Section 223	Clause 71 has been amended to specifically reference Section 223 of the Local Government Act 1989. While such specific references have otherwise been removed from the MPLL18, it is anticipated that the Act, when remade, will not include an equivalent of Section 223.
74, 75 & 76	Amendment of provision regarding other committees	Clauses 74, 75 and 76 have been amended to remove reference to advisory committees.
Part 5 76 & 77	Deletion of Part 5 regarding supply of information.	Part 5 provides that Council may charge fees for the supply of information. Council’s power to charge fees for certain documents is established under the Act and fees may be set as part of the Fees and Charges in the annual budget process. As such, these provisions are considered to no longer be required.

14. URGENT BUSINESS**14.1 URGENT BUSINESS**

Nil.

14.2 CALL UP ITEMS**14.2.1 Priority of Access to Knox Preschools****COUNCIL RESOLUTION**

MOVED: CR. GILL
SECONDED: CR. COOPER

That Council prepare a report for the May Council Meeting investigating the priority of access criteria other Councils use for Children's Preschool placement to be considered as part of the review of the Knox Priority of Access Policy

WITHDRAWN

14.2.2 Sports Demand Analysis**COUNCIL RESOLUTION**

MOVED: CR. KEOGH
SECONDED: CR. SEYMOUR

That Council receive two separate reports at the Ordinary Council Meeting on 25 June 2018:

1. The first outlining what is required to undertake a sports demand analysis for The City of Knox across all sporting codes;
2. The second outlining what is required to undertake a place based analysis of sporting facilities and active reserves in the Rowville and Lysterfield suburbs.

CARRIED

15. QUESTIONS WITHOUT NOTICE

Councillor Seymour noted she was aware the Federal Minister for Sport, The Hon Bridget McKenzie, was visiting Knox and questioned the reason for her visit.

The CEO, Mr Doyle confirmed that Senator McKenzie would be visiting Knox on 28th April. The main purpose of the visit is to see the Knox Regional Sports Park. This visit has been arranged by the Hon Alan Tudge.

Councillor Taylor questioned whether there would be clarification in the new Meeting Procedure Local Law surrounding Subsequent Motions. Governance Advisor Mr McKail advised that this would be addressed.

Official Minutes of Knox City Council

PROCEDURAL MOTION**CLOSURE OF MEETING****MOVED: CR. PEARCE****SECONDED: CR. TAYLOR**

That in accordance with Sections 89 (2) of the Local Government Act, 1989, the Meeting be closed to members of the public on the basis that discussion is required on matters set out in:

Item 6.4 – Construction of a Community Workshop and Horticultural Area at Rowville Recreation Reserve – Section 89(2)(e) of the Local Government Act due to proposed developments

Item 10.5 – Appointment of Council and Independent Members to the Knox ICT Governance Committee – Section 89(2)(h) of the Local Government Act as it relates to matters the premature disclosure of which would prejudice the Council or any person as it as it

CARRIED**THE MEETING WAS CLOSED TO THE PUBLIC AT 9.05PM**

Official Minutes of Knox City Council

AS PER THE PROCEDURAL MOTION ITEM 6.4 - CONSTRUCTION OF A COMMUNITY WORKSHOP AND HORTICULTURAL AREA AT ROWVILLE RECREATION RESERVE AND ITEM 10.5 APPOINTMENT OF COUNCIL AND INDEPENDENT MEMBERS TO THE KNOX COUNCIL ICT GOVERNANCE COMMITTEE WERE MOVED AND CONSIDERED AFTER ITEM 15 – QUESTIONS WITHOUT NOTICE

COUNCILLOR GILL VACATED THE CHAMBER AT 9.05PM PRIOR TO DISCUSSION ON ITEM 6.4

COUNCILLOR HOLLAND VACATED THE CHAMBER AT 9.05PM PRIOR TO DISCUSSION ON ITEM 6.4

COUNCILLOR GILL RETURNED TO THE CHAMBER AT 9.07PM DURING DISCUSSION ON ITEM 6.4

COUNCILLOR HOLLAND RETURNED TO THE CHAMBER AT 9.07PM DURING DISCUSSION ON ITEM 6.4

TAYLOR AND TIRHATUAN WARDS

6.4. CONSTRUCTION OF A COMMUNITY WORKSHOP AND HORTICULTURAL AREA AT ROWVILLE RECREATION RESERVE

A confidential report was discussed and resolved upon in camera.

ALL WARDS

10.5 APPOINTMENT OF COUNCIL AND INDEPENDENT MEMBERS TO THE KNOX COUNCIL ICT GOVERNANCE COMMITTEE

SUMMARY: *Acting Manager – Information Technology
(Paul Barrett)*

The Knox Council ICT Governance Committee (the Committee) is to be established as an advisory committee of Council and currently has three independent member vacancies. In accordance with the Committee's Terms of Reference, recruitment for three independent members has been completed and this report recommends the appointment of Tom Wilsdon, Chris Gillies and Rob Heselev to the Committee.

RECOMMENDATION

That Council

1. Appoint Tom Wilsdon as an independent member of the Knox Council ICT Governance Committee until December 2020
2. Appoint Chris Gillies as an independent member of the Knox Council ICT Governance Committee until December 2019
3. Appoint Rob Heselev as an independent member of the Knox Council ICT Governance Committee until December 2018
4. Appoint the Mayor of the day and Councillor ___ and Councillor ___ to the ICT Governance Committee
5. Appoint Councillor _____ as Chair of the ICT Governance Committee in accordance with the ICT Governance Committee Terms of Reference
6. Advise all applicants of Council's decision and thank them for their interest in the Knox Council ICT Governance Committee.
7. That these resolutions be no longer confidential following the Council meeting

1. INTRODUCTION

In accordance with the resolution of Council made at its Ordinary Meeting on 28 August 2017 and the Knox Council ICT Governance Committee Terms of Reference attached as Appendix A, a recruitment process for three independent members has been undertaken with three recommended candidates identified.

This report is to advise Council of the process undertaken to select three independent members for the Knox Council ICT Governance Committee and recommends Council appoint the recommended applicants of the selection panel.

10.5 Appointment of Independent Members to the Knox Council ICT Governance Committee (cont'd)

2. DISCUSSION

The primary objective of the Knox Council ICT Governance Committee is to assist and advise Council and Council's management in the delivery of the ICT strategy. The ICT Governance Committee will provide advice and guidance around, management of risk, industry best practices, strategic planning and operation of good governance practices.

The Knox Council ICT Governance Committee membership comprises:

- Two Councillors
- Three Independent Members
- The Mayor, who is an ex-officio member (no voting entitlement)

At the Ordinary Meeting of Council held on 28 August 2017, Council resolved:

'That Council

1. *Approve the formation of an ICT Governance Committee as an Advisory Committee of Council.*
2. *Approve the Terms of Reference for the ICT Governance Committee with the following amendments to section 3:*
 - a. *delete reference to One Independent member from the Knox Audit Committee in membership composition*
 - b. *increase the number of Independent external members to three*
 - c. *remove the paragraph that reads:*
 - i. *Where an independent member from the Audit Committee is unable to fulfil the ICTGC membership position, an additional independent external member will be recruited.*
3. *Approve in principle the payment of a fee to the three proposed independent external members appointed to the ICT Governance Committee.*
4. *Commence a recruitment process for the independent external members in accordance with the Terms of Reference.*
5. *Establish a selection panel comprising of the Mayor, Cr Darren Pearce, Chief Executive Officer, Tony Doyle and Director Corporate Services, Michael Fromberg, to review all applications, recommend preferred candidates for appointment and recommend an appropriate fee for the independent members for approval by Council.*

10.5 Appointment of Independent Members to the Knox Council ICT Governance Committee (cont'd)

In accordance with this resolution, the recruitment process commenced by the placement of a public advertisement in The Age newspaper and Council Website calling for expressions of interest.

In addition to these advertisements, various external resources were engaged to provide resumes of candidates with interest in the ICT Governance Committee.

At the close of the expression of interest period, a total of seven (7) expressions of interest had been received. Following the review and interviews of all expressions of interest, the three (3) preferred candidates were presented to the selection panel comprising of the Mayor, Cr John Mortimore and Chief Executive Officer, Tony Doyle for consideration.

The selection panel noted the presentation of the 3 candidates and requested these were presented to council along with details of all 7 applicants. A consolidated list of applicants and details have been provided with a recommendation of three preferred candidates who's skills and experience best align with the purpose of the committee.

The applicants were evaluated against the following criteria:

1. Demonstrated experience in Information Technology, ICT strategic planning, risk management, governance, cultural transformation and executive management.
2. Demonstrated experience providing advice on the adequacy of policies, systems and internal controls on matters within the scope of the ICT Governance Committee.
3. A strong understanding of Local Government, including internal policies, Community Services and legislative reporting requirements.
4. Strong demonstrated experience in project management and delivery and experience in managing cultural transformation through an organisation

An overview of the applicants short listed and considered through the interview process is document in Confidential Appendix B and further information on each candidate can be found in Confidential Appendix C.

10.5 Appointment of Independent Members to the Knox Council ICT Governance Committee (cont'd)

Following the interview and evaluation process the candidates recommended for appointment by the selection panel are:

- Tom Wilsdon – Group Manager Business Improvement and Technology
- Chris Gillies – Strategic Consultant
- Rob Heselev – Development Consultant - Heselev Consulting

The shortlisted candidates have extensive senior level management, IT Management, risk management and audit experience. Extensive experience of the operations of Governance Committees including local government ICT Committees and a reasonable knowledge of the business of local government and its changing operating environment. Combined, the short listed candidates bring to the ICT Governance Committee, a capacity to advise Council in relation to information technology, risk management, industry best practises and cultural transformation.

The term of appointment of independent members is staggered in accordance with the Terms of Reference and to limit the potential loss of experienced independent members at the same time.

3. CONSULTATION

No external consultation has been undertaken in this matter.

4. ENVIRONMENTAL/AMENITY ISSUES

There are no environmental or amenity issues associated with this report.

5. FINANCIAL & ECONOMIC IMPLICATIONS

Council resolved at the Ordinary meeting held on 28 August 2017 that independent members of the Knox Council ICT Governance Committee receive a set remuneration, with payments made at the conclusion of each quarter. The remuneration for each Committee sitting is \$1350 for each independent member appointed to the Knox Council ICT Governance Committee. Councillors appointed to the ICT Governance Committee do not receive an additional allowance.

6. SOCIAL IMPLICATIONS

There are no social implications in relation to this report.

10.5 Appointment of Independent Members to the Knox Council ICT Governance Committee (cont'd)

7. RELEVANCE TO COUNCIL AND COMMUNITY PLAN (2017-21)

The establishment and work of the Knox Council ICT Governance Committee supports initiative 8.1.4 (Implement staged delivery of the ICT Roadmap to support organisational efficiency and effectiveness and to increase capacity for customer self-service) within strategy 8.1, which seeks to “build, strengthen and promote good governance practices across government and community organisations”.

8. CONFLICT OF INTEREST

Under section 80c of the Local Government Act 1989 officers providing advice to Council must disclose any interests, including the type of interest.

Officer Responsible – Paul Barrett, Acting Manager Information Technology- In providing this advice as the Officer Responsible, I have no disclosable interests in this report.

Author – Paul Barrett, Acting Manager Information Technology - In providing this advice as the Author, I have no disclosable interests in this report.

9. CONCLUSION

The Knox Council ICT Governance Committee will play an integral role in the governance of all ICT projects and business cases submitted to Council. Having independent members on the Committee provides an external review capability and independent expertise to advise Council and Council's management on fulfilling their responsibilities in relation to delivery of the ICT Strategy, management of risk, good governance practices and facilitation of cultural transformation. To ensure that Council is serviced with high quality independent members a rigorous evaluation process has been undertaken to ensure the high standards of operation of the Knox Council ICT Governance Committee are continued. The preferred candidates have the expertise and experience to provide the Council with necessary high-level professional advice on matters considered by the Committee. The preferred candidates, recommended for appointment as independent members to the Knox Council ICT Governance Committee are presented for Council consideration.

10. CONFIDENTIALITY

This report is being treated as confidential as it contains personal information in relation to the candidates. *The premature disclosure of which would prejudice the Council or any person*

10.5 Appointment of Independent Members to the Knox Council ICT Governance Committee (cont'd)**COUNCIL RESOLUTION****MOVED: CR. LOCKWOOD****SECONDED: CR. PEARCE**

That Council

1. Note that the Mayor is a full member of the Committee and not an ex-officio member as referenced in the report.
2. Note that the incorrect Terms of Reference were attached to the report and that the version approved by Council on the 28th August 2017 be attached to the minutes of the meeting.
3. Appoint Tom Wilsdon as an independent member of the Knox Council ICT Governance Committee until December 2020.
4. Appoint Chris Gillies as an independent member of the Knox Council ICT Governance Committee until December 2019.
5. Appoint Rob Heselev as an independent member of the Knox Council ICT Governance Committee until December 2018.
6. Appoint the Mayor of the day and Councillor Lockwood and Councillor Pearce to the ICT Governance Committee.
7. Note that the Chair of the ICT Governance Committee will be elected at the first meeting in accordance with the ICT Governance Committee Terms of Reference.
8. Advise all applicants of Council's decision and thank them for their interest in the Knox Council ICT Governance Committee.
9. That the confidential report (excluding confidential Appendix B) and Council resolution be no longer confidential and be incorporated into the public minutes of the meeting.

CARRIED



TERMS OF REFERENCE

INFORMATION COMMUNICATION TECHNOLOGY (ICT) GOVERNANCE COMMITTEE

Directorate	Corporate Development
Responsible Officer	Director Corporate Development
Committee Type	Advisory
Approval Date:	28 August 2017
Review Date:	28 August 2021

1. PURPOSE

The Knox City Council ICT Governance Committee ("ICTGC") is an Advisory Committee of Knox City Council. The Committee's purpose is to evaluate, recommend and monitor IT-enabled projects regarding future investment in changed or new IT capability in accordance with AS/NZS 8016:2013 (Governance of IT-enabled Projects).

2. OBJECTIVES

The objectives of the ICTGC are to:

- Oversee the implementation of the Digital Strategy, the ICT Strategy and ICT Roadmap
- Evaluate and recommend IT-enabled projects regarding future investment in changed or new IT capability, via a review of project briefs and/or business cases demonstrating strategic alignment, IT solution options, risk management plans and return on investment predictions and making recommendations to Council.
- Provide guidance and recommendations regarding strategic investment priorities, decision making responsibilities and project methodologies, provide strategic advice to project teams via their Project Steering Committee.
- Provide oversight and monitor the implementation of the approved IT program of work including key risks and dependencies and review budget, schedule and scope changes to ensure the organisation realises benefit and value from its IT investments
- Provide oversight and support the principles of IT governance as detailed in AS ISO/IEC 38500:2016 and the Knox City Council IT Governance Model.
- Provide recommendations to inform the decision making process of Council (the governing body) regarding investment in IT-enabled projects.
- Report to Council all recommendations as determined by the ICTGC, and

any other matter or issue considered appropriate and within the ICTGC's Terms of Reference.

3. MEMBERSHIP, PERIOD OF MEMBERSHIP AND METHOD OF APPOINTMENT

The membership of the Committee shall comprise:

- Mayor
- Two Councillors
- Three Independent external members

Independent external members will have a background in the ICT industry and or governance. An awareness of local government would be an advantage.

Any Councillor, not appointed to the Committee, may attend the meeting and will not have any voting entitlement.

3. 1. METHOD OF APPOINTMENT OF COUNCILLORS TO THE COMMITTEE

Councillors will be appointed to the Committee through Council's annual Committee appointment process.

3. 2. METHOD OF APPOINTMENT OF INDEPENDENT MEMBERS TO THE COMMITTEE

The appointment of independent members will be by way of public expression of interest process. The evaluation of potential members will be undertaken by the Mayor, or Councillor nominated by the Mayor, Chief Executive Officer and the Director Corporate Development using appropriate selection criteria. The appointment of independent members will be recommended following evaluation, through a report to Council.

3. 3. TERM OF APPOINTMENT OF INDEPENDENT MEMBERS

The term of an independent member will be for a maximum period of three years from the date of appointment following which the Council may reappoint the member or advertise for expressions of interest to appoint a new member.

Where an independent member has not been in attendance for two consecutive meetings, without submitting an apology or been granted a leave of absence, a casual vacancy will be created.

Where a casual vacancy is created with the departure of an independent member from the Committee the position will be filled using the independent member's appointment process, except where a casual vacancy occurs within 12 months of an expression of interest (EOI) process. In this case, a direct appointment can be made by Council from the shortlisted candidates from the most recent EOI process.

3.4. INDEPENDENCE OF MEMBERS

Any Committee member can submit an issue to the Director Corporate Development for placement on the Agenda for the next appropriate meeting of the ICTGC Committee, where the Committee Member may be afforded the opportunity to address the meeting. In addition, the Chairperson may submit any report prepared by the Committee to be tabled at the next Ordinary meeting of the Council.

3.5. INDUCTION OF INDEPENDENT MEMBERS

Council shall provide a detailed independent member induction that will highlight the current issues that are applicable to the ICTGC within Council and detailed written reference material.

4. DELEGATED AUTHORITY AND DECISION MAKING

Advisory Committees act in an advisory capacity only and have no delegated authority to make decisions as if they were the Council. Advisory Committees provide advice to Council and staff to assist them in their decision making.

The ICTGC, by resolution, may request to meet with other Council Committees or external parties in consideration of a specific matter before the ICTGC.

5. MEETING PROCEDURES

- The Committee will meet a maximum of six times per annum. A schedule of meetings will be developed and agreed to by the members at the first meeting each year.
- Due to the sensitive nature of the material routinely considered by the (ICTGC) Committee meetings are not open to the public and all meeting agendas, minutes and proceedings are deemed confidential.
- Extra meetings may be scheduled on request of the Chairperson or any three members of the Committee after consultation with the Director Corporate Development.
- The Committee can request through the Director Corporate Development other staff members or any other person if deemed necessary to attend meetings as may be required.
- Where practicable, the responsible Director or Manager will be present for tabling of a business case for a proposed IT-enabled projects.
- Other Council staff may attend meetings at the CEO's request where issues require clarification.
- The quorum for each meeting is a majority of members.

6. CHAIR

The members of the Committee will appoint a Chairperson annually at the commencement of the first meeting each calendar year. The Chairperson is to be an independent member of the Committee. The members of the Committee may also appoint a Deputy Chairperson who is to be an independent Committee member, to undertake the duties of the Chairperson where the

elected person may not be able to undertake their duties.

When appointing the Chairperson, the Committee should consider a candidate's relevant professional and personal skills required to undertake this role.

7. AGENDAS AND MINUTES

Minutes will be taken of each Committee meeting and will include issues discussed, general outcomes of discussions and formal resolutions of the Committee. The attendance of Committee members and Council officers will be recorded.

Minutes will be presented for formal endorsement at the next meeting of the Committee.

The endorsed minutes of each meeting will be made available to all Councillors as soon as practicable after the meeting.

8. VOTING

When the ICTGC is unable to determine a matter by consensus, the matter will be determined by a vote.

Councillor and independent members have voting rights.

Staff provide support and advice to the Committee only and have no voting rights.

In the event of an equality of votes the Chairperson has a second, casting vote.

9. CONFLICT AND INTEREST PROVISIONS

Committee members are subject to the provisions of S76D (Misuse of Position) and S79 (Conflict of Interest) of the Local Government Act. Independent members of the Committee are also required to submit Primary or Ordinary Returns (reference: S81, Local Government Act).

- In performing the role of a Committee member, a person must:
- act honestly;
- exercise reasonable care and diligence;
- not make improper use of their position; and
- not make improper use of information acquired because of their position.

10. REPORTING

The ICTGC will provide an annual report to the Council on its activities and achievements in accordance with the objectives stated in these Terms of Reference.

11. ADMINISTRATION SUPPORT

Administration support will be provided by the Corporate Development Directorate.

12. CONTACT WITH THE MEDIA

Contact with the media by members of the Committee will be conducted in accordance with the Councillor and Staff Media Policies.

13. REVIEW DATE

The Terms of Reference will be reviewed within 4 years of the date of adoption.

14. MEALS

The provision of refreshments will be in accordance with the Meals and Sustenance Policy.

15. ADMINISTRATIVE UPDATES

From time to time, circumstances may change leading to the need for minor administrative changes to these Terms of Reference (ToR). Where an update does not materially alter the ToR, such a change may be made administratively. Examples of minor administrative changes include changes to names of Council departments or positions, change to names of Federal or State Government departments or a minor amendment to legislation that does not have material impact. Where any change or update may materially change the intent of the ToR, it must be considered by Council.

PROCEDURAL MOTION

MOVED: CR. PEARCE
SECONDED: CR. TAYLOR

That the meeting be re-opened to the Public.

CARRIED

THE MEETING REOPENED TO THE PUBLIC AT 9.22PM

MEETING CLOSED AT 9.23PM

Minutes of Meeting confirmed at the
Ordinary Meeting of Council
held on
Monday, 23 April 2018

.....
Chairperson